

WOUND CLOSURE PRODUCT CATALOG



Medtronic
Further, Together

HOW TO READ A SUTURE LABEL

COVIDIEN™

CL-812 Reorder Code

Material **Polysorb™**

Braided Absorbable Suture

USP / EP Diameter **0**

3.5 Metric

Suture Length **30" 75 cm VIOLET** Color

Needle Description **GS-21 TAPER**























Quantity Per Box **36**

1/2 37 mm

Lot Number, Expiration Date, Manufacturing Date, Bar Code **LOT 123456789 Use by 2018-07**

(01)20884521049694

CONTENTS

	VELOSORB™ FAST sutures
	POLYSORB™ sutures
	CAPROSYN™ sutures
	BIOSYN™ sutures
	MAXON™/MAXON™ CV sutures
	CHROMIC GUT sutures
	MILD CHROMIC GUT sutures
	PLAIN GUT sutures
	SURGIPRO™/SURGIPRO II™ sutures
	TI-CRON™/SURGIDACT™ sutures
	VASCUFIL™ sutures
	FLEXON™ sutures
	STEEL sutures
	DERMALON™/MONOSOFT™ sutures
	NOVAFIL™ sutures
	SURGILON™ sutures
	SOFSILK™ sutures
	V-LOC™ 90 wound closure device
	V-LOC™ 180 wound closure device
	V-LOC™ PBT wound closure device
	PLEDGETS MEDTRONIC sutures
	BONE WAX sutures

VELOSORB™ FAST

Coated, Braided Synthetic Absorbable Sutures

Description	Velosorb™ Fast absorbable braided sutures are composed of an absorbable synthetic polyester comprised of glycolide and lactide (derived from glycolic and lactic acids). Velosorb™ fast absorbable sutures are prepared by coating the suture with a mixture of a glycolide and lactide copolymer and calcium stearate.
Indications	Velosorb™ Fast absorbable sutures are indicated for use in soft tissue approximation of the skin and mucosa, where only 7-10 days of wound support is required, but not for use in ligation, cardiovascular or neurological tissue.
Actions	Velosorb™ Fast absorbable sutures elicit a minimal acute inflammatory reaction in tissue, which is followed by a gradual encapsulation of the suture by fibrous connective tissue. Progressive loss of tensile strength and eventual absorption of Velosorb™ Fast absorbable sutures occurs by means of hydrolysis, where the glycolide/lactide copolymer is broken down to glycolic and lactic acids which are subsequently absorbed and metabolized by the body.
Tensile Strength	Tensile strength averages for Velosorb™ Fast absorbable sutures are no less than 45% of its original tensile strength 5 days post implantation. All of the original tensile strength is essentially gone by 14 days.
Sterilization	Gamma irradiation.
Absorption	Absorption begins as a loss of tensile strength without appreciable loss of mass. Absorption of Velosorb™ Fast absorbable sutures is essentially complete between the 40th and 50th day.
Packaging	Velosorb™ fast absorbable sutures are available in USP sizes 1 (4 Metric) through 8-0 (0.4 Metric). They are available undyed (natural). The sutures are supplied sterile, in pre-cut lengths affixed to various needle types. Please refer to the individual package IFUs for complete instructions, indications, contraindications, warnings and precautions.

VELOSORB™ FAST

Coated, Braided Synthetic Absorbable Sutures

NON NEEDED - PRE-CUT								
Description	USP Size	EP Size	Length (in)	Length (cm)	Color	Units per box	Comments	Reorder code
PRE-CUT	4-0	1.5	18	45	UNDYED	36		CV-8643
	4-0	1.5	18	45	UNDYED	36	6 strands	CV-8977
	4-0	1.5	18	45	UNDYED	36		CV8643
	3-0	2	18	45	UNDYED	36	6 strands	CV-8978
	3-0	2	18	45	UNDYED	36	3 strands	CV-8644
	2-0	3	18	45	UNDYED	36	6 strands	CV-8979
	2-0	3	30	75	UNDYED	36	Pre-Cut	CV-8653
	2-0	3	30	75	UNDYED	36	Pre-Cut	CV8653
	0	3.5	18	45	UNDYED	36	6 strands	CV-8980

NON NEEDED - STANDARD LENGTH								
Description	USP Size	EP Size	Length (in)	Length (cm)	Color	Units per box	Comments	Reorder code
STANDARD LENGTH	3-0	2	60	150	UNDYED	12		CV9006G
	3-0	2	60	150	UNDYED	12		CV-9006G
	2-0	3	60	150	UNDYED	12	Standard Length	CV-9007G

Surgipro™ II and Surgipro™ 7-0, 8-0; Sofsilik™ 8-0; Polysorb™, Biosyn™, Monosof™, Maxon™, Velosorb™ Fast sutures differ from USP and EP only in diameter. Please refer to IFU for more details.

© 2018 Medtronic. All rights reserved. Medtronic, Medtronic logo and Further, Together are trademarks of Medtronic.







™*Third party brands are trademarks of their respective owners.

All other brands are trademarks of a Medtronic company.

11/2018 US170542

VELOSORB™ FAST

Coated, Braided Synthetic Absorbable Sutures

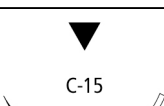
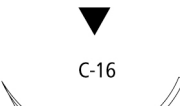
REVERSE CUTTING									
Description	USP Size	EP Size	Length (in)	Length (cm)	Color	Units per box	Comments	Reorder code	
C-1 3/8 CIRCLE 12mm 	5-0	1	30	75	UNDYED	36	Reliapro™ needle	SV-2289	
	4-0	1.5	18	45	UNDYED	36	Reliapro™ needle	SV-1290	
	4-0	1.5	30	75	UNDYED	36	Reliapro™ needle	SV-2290	
C-12 3/8 CIRCLE 16mm 	5-0	1	30	75	UNDYED	36	Reliapro™ needle	SV-2296	
	4-0	1.5	30	75	UNDYED	36	Reliapro™ needle	SV-2294	
	3-0	2	30	75	UNDYED	36	Reliapro™ needle	SV-2295	
C-13 3/8 CIRCLE 19mm 	5-0	1	18	45	UNDYED	36	Reliapro™ needle	SV-2910	
	4-0	1.5	18	45	UNDYED	36	Reliapro™ needle	SV-2920	
	4-0	1.5	30	75	UNDYED	36	Reliapro™ needle	SV-2297	
	3-0	2	18	45	UNDYED	36	Reliapro™ needle	SV-2930	
	3-0	2	30	75	UNDYED	36	Reliapro™ needle	SV-2298	
	2-0	3	30	75	UNDYED	36	Reliapro™ needle	SV-2299	
C-14 3/8 CIRCLE 24mm 	4-0	1.5	30	75	UNDYED	36	Reliapro™ needle	SV-2251	
	3-0	2	18	45	UNDYED	36	Reliapro™ needle	SV-4431	
	3-0	2	30	75	UNDYED	36	Reliapro™ needle	SV-2252	
	2-0	3	30	75	UNDYED	36	Reliapro™ needle	SV-2253	
C-14 - KV-34 3/8 CIRCLE 24mm 	2-0/0	3/3.5	36	90	UNDYED	24	SET-3 Strands : 1 strand 0 30"/75cm C-14 /2 strands 2-0 36"/90cm KV-34, Reliapro™ needle	CV-0146	
C-14 - KV-37 3/8 CIRCLE 24mm 	2-0/0	3/3.5	36	90	UNDYED	24	SET-3 Strands : 1 strand 0 30"/75cm C-14 /2 strands 2-0 36"/90cm KV-37, Reliapro™ needle	CV-0046	
C-15 3/8 CIRCLE 26mm 	3-0	2	30	75	UNDYED	12	Reliapro™ needle	SV-9940G	
	2-0	3	30	75	UNDYED	12	Reliapro™ needle	SV-9941G	
C-16 3/8 CIRCLE 30mm 	3-0	2	36	90	UNDYED	36	Reliapro™ needle	SV-2285	
	2-0	3	36	90	UNDYED	36	Reliapro™ needle	SV-2286	
	0	3.5	36	90	UNDYED	36	Reliapro™ needle	SV-2287	

Surgipro™ II and Surgipro™ 7-0, 8-0; Sofsilik™ 8-0; Polysorb™, Biosyn™, Monosof™, Maxon™, Velosorb™ Fast sutures differ from USP and EP only in diameter. Please refer to IFU for more details.

© 2018 Medtronic. All rights reserved. Medtronic, Medtronic logo and Further, Together are trademarks of Medtronic.





™*Third party brands are trademarks of their respective owners.

All other brands are trademarks of a Medtronic company.

11/2018 US170542

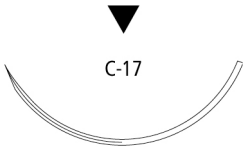
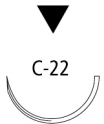
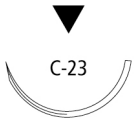
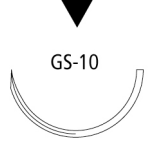
VELOSORB™ FAST

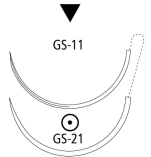
Coated, Braided Synthetic Absorbable Sutures

REVERSE CUTTING									
Description	USP Size	EP Size	Length (in)	Length (cm)	Color	Units per box	Comments	Reorder code	
C-17 3/8 CIRCLE 39mm 	2-0	3	30	75	UNDYED	12	Reliapoint™ needle	SV-9961G	
C-22 1/2 CIRCLE 18mm 	4-0	1.5	18	45	UNDYED	36	Reliapoint™ needle	SV-4550	
C-23 1/2 CIRCLE 24mm 	4-0	1.5	18	45	UNDYED	36	Reliapoint™ needle	SV-9926	
	3-0	2	18	45	UNDYED	36	Reliapoint™ needle	SV-9927	
	2-0	3	18	45	UNDYED	36	Reliapoint™ needle	SV-9928	
GS-10 1/2 CIRCLE 26mm 	2-0	3	30	75	UNDYED	12		CV-9936G	
GS-11 1/2 CIRCLE 37mm 	2-0	3	36	90	UNDYED	36		CV-4721	
	0	3.5	36	90	UNDYED	36		CV-4731	
GS-11 - GS-21 1/2 CIRCLE 37mm (Double armed) (Not to scale) 	3-0	2	54	135	UNDYED	12		CV-931G	
	2-0	3	54	135	UNDYED	12		CV-932G	
GS-12 1/2 CIRCLE 40mm 	0	3.5	36	90	UNDYED	36		CV-485	
	1	4	36	90	UNDYED	36		CV-486	

Surgipro™ II and Surgipro™ 7-0, 8-0; Sofsilik™ 8-0; Polysorb™, Biosyn™, Monosof™, Maxon™, Velosorb™ Fast sutures differ from USP and EP only in diameter. Please refer to IFU for more details.

© 2018 Medtronic. All rights reserved. Medtronic, Medtronic logo and Further, Together are trademarks of Medtronic.







™*Third party brands are trademarks of their respective owners.

All other brands are trademarks of a Medtronic company.

11/2018 US170542

VELOSORB™ FAST

Coated, Braided Synthetic Absorbable Sutures

PREMIUM REVERSE CUTTING									
Description	USP Size	EP Size	Length (in)	Length (cm)	Color	Units per box	Comments	Reorder code	
P-10 3/8 CIRCLE 11mm 	6-0	0.7	18	45	UNDYED	36	Edgellant™ needle, Surgalloy™ alloy	SV-9913	
	6-0	0.7	18	45	VIOLET	36	Edgellant™ needle, Surgalloy™ alloy	SV-32	
	6-0	0.7	30	75	UNDYED	36	Edgellant™ needle, Surgalloy™ alloy	SV-4893	
	5-0	1	18	45	UNDYED	36	Edgellant™ needle, Surgalloy™ alloy	SV-9915	
P-13 3/8 CIRCLE 13mm 	5-0	1	18	45	UNDYED	36	Edgellant™ needle, Surgalloy™ alloy	SV-493	
	4-0	1.5	18	45	UNDYED	36	Edgellant™ needle, Surgalloy™ alloy	SV-494	
	4-0	1.5	30	75	UNDYED	36	Edgellant™ needle, Surgalloy™ alloy	SVP-494	
P-11 3/8 CIRCLE 16mm 	5-0	1	30	75	UNDYED	36	Edgellant™ needle, Surgalloy™ alloy	SVP-2296	
	4-0	1.5	30	75	UNDYED	36	Edgellant™ needle, Surgalloy™ alloy	SVP-2294	
	3-0	2	30	75	UNDYED	36	Edgellant™ needle, Surgalloy™ alloy	SVP-2295	
P-12 3/8 CIRCLE 19mm 	4-0	1.5	18	45	UNDYED	12	Edgellant™ needle, Surgalloy™ alloy	SV-496G	
	4-0	1.5	18	45	UNDYED	36	Edgellant™ needle, Surgalloy™ alloy	SV-496	
	4-0	1.5	30	75	UNDYED	36	Edgellant™ needle, Surgalloy™ alloy	SV-426	
	4-0	1.5	36	90	UNDYED	36		SV412	
	3-0	2	18	45	UNDYED	12	Edgellant™ needle, Surgalloy™ alloy	SV-497G	
	3-0	2	30	75	UNDYED	36	Edgellant™ needle, Surgalloy™ alloy	SV-425	
	2-0	3	30	75	UNDYED	36	Edgellant™ needle, Surgalloy™ alloy	SV-424	
P-14 3/8 CIRCLE 24mm 	4-0	1.5	30	75	UNDYED	36	Edgellant™ needle, Surgalloy™ alloy	SVP-2251	
	3-0	2	18	45	UNDYED	36	Edgellant™ needle, Surgalloy™ alloy	SV-6830	
	3-0	2	30	75	UNDYED	36	Edgellant™ needle, Surgalloy™ alloy	SV-935	
	2-0	3	18	45	UNDYED	36	Edgellant™ needle, Surgalloy™ alloy	SV-6840	
	2-0	3	30	75	UNDYED	36	Edgellant™ needle, Surgalloy™ alloy	SV-439	
P-17 3/8 CIRCLE 30mm 	3-0	2	36	90	UNDYED	36		SVP-2285	

Surgipro™ II and Surgipro™ 7-0, 8-0; Sofsilik™ 8-0; Polysorb™, Biosyn™, Monosof™, Maxon™, Velosorb™ Fast sutures differ from USP and EP only in diameter. Please refer to IFU for more details.

© 2018 Medtronic. All rights reserved. Medtronic, Medtronic logo and Further, Together are trademarks of Medtronic.



™*Third party brands are trademarks of their respective owners.

All other brands are trademarks of a Medtronic company.

11/2018 US170542

VELOSORB™ FAST

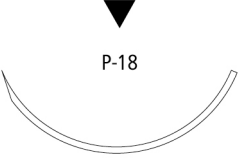
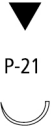
Coated, Braided Synthetic Absorbable Sutures

PREMIUM REVERSE CUTTING									
Description	USP Size	EP Size	Length (in)	Length (cm)	Color	Units per box	Comments	Reorder code	
P-18 3/8 CIRCLE 39mm 	3-0	2	30	75	UNDYED	12	Edgellant™ needle, Surgalloy™ alloy	SV-9937G	
	2-0	3	30	75	UNDYED	12	Edgellant™ needle, Surgalloy™ alloy	SV-9938G	
P-21 1/2 CIRCLE 9mm 	4-0	1.5	18		UNDYED	36	Edgellant™ needle, Surgalloy™ alloy	SV1642	
	4-0	1.5	18	45	UNDYED	36	Edgellant™ needle, Surgalloy™ alloy	SV-1642	
P-24 1/2 CIRCLE 16mm 	5-0	1	18	45	UNDYED	12	Edgellant™ needle, Surgalloy™ alloy	SV-9910G	
	4-0	1.5	18	45	UNDYED	12	Edgellant™ needle, Surgalloy™ alloy	SV-9911G	

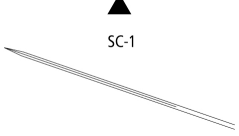
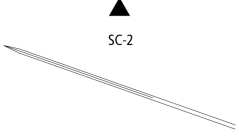
CONVENTIONAL CUTTING									
Description	USP Size	EP Size	Length (in)	Length (cm)	Color	Units per box	Comments	Reorder code	
SC-11 STRAIGHT 11mm 	4-0	1.5	18	45	UNDYED	12		SV-9909G	
SC-1 STRAIGHT 51mm (Not to scale) 	4-0	1.5	30	75	UNDYED	36		SV-2238	
	3-0	2	30	75	UNDYED	36		SV-2239	
	2-0	3	30	75	UNDYED	36		SV-2240	
SC-2 STRAIGHT 60mm (Not to scale) 	3-0	2	30	75	UNDYED	36		SV-9943	
	2-0	3	30	75	UNDYED	12		SV-9944G	

Surgipro™ II and Surgipro™ 7-0, 8-0; Sofsilik™ 8-0; Polysorb™, Biosyn™, Monosof™, Maxon™, Velosorb™ Fast sutures differ from USP and EP only in diameter. Please refer to IFU for more details.

© 2018 Medtronic. All rights reserved. Medtronic, Medtronic logo and Further, Together are trademarks of Medtronic.



™*Third party brands are trademarks of their respective owners.

All other brands are trademarks of a Medtronic company.

11/2018 US170542

VELOSORB™ FAST

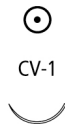
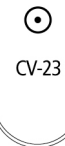
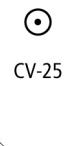
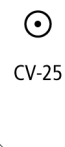
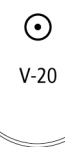
Coated, Braided Synthetic Absorbable Sutures

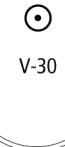
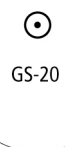
TAPER POINT									
Description		USP Size	EP Size	Length (in)	Length (cm)	Color	Units per box	Comments	Reorder code
CV-1 3/8 CIRCLE 9mm	 CV-1	8-0	0.4	12	30	VIOLET	12		CV-9916G
CV-23 1/2 CIRCLE 17mm	 CV-23	5-0	1	30	75	UNDYED	36		CV-1213
		4-0	1.5	30	75	UNDYED	36		CV-1214
		3-0	2	30	75	UNDYED	36		CV-1215
CV-25 1/2 CIRCLE 22mm	 CV-25	2-0	3	30	75	UNDYED	36		CV-3120
CV-25 OPTIVIS 1/2 CIRCLE 22mm	 CV-25	4-0	1.5	30	75	UNDYED	36		CV-3100
		3-0	2	30	75	UNDYED	36		CV-3110
V-20 1/2 CIRCLE 26mm	 V-20	4-0	1.5	30	75	UNDYED	36		CV-415
		3-0	2	30	75	UNDYED	12		CV-416G
		2-0	3	30	75	UNDYED	12		CV-417G
		0	3.5	30	75	UNDYED	36		CV-418
GS-22 1/2 CIRCLE 27mm	 GS-22	2-0	3	30	75	UNDYED	36		CV-55
		0	3.5	30	75	UNDYED	36		CV-56
		1	4	30	75	UNDYED	36		CV-57
V-30 1/2 CIRCLE 30mm	 V-30	0	3.5	30	75	UNDYED	36		CV-318
		1	4	30	75	UNDYED	36		CV-319
GS-20 1/2 CIRCLE 34mm	 GS-20	2-0	3	30	75	UNDYED	12		CV-9975G

Surgipro™ II and Surgipro™ 7-0, 8-0; Sofsilik™ 8-0; Polysorb™, Biosyn™, Monosof™, Maxon™, Velosorb™ Fast sutures differ from USP and EP only in diameter. Please refer to IFU for more details.

© 2018 Medtronic. All rights reserved. Medtronic, Medtronic logo and Further, Together are trademarks of Medtronic.

™*Third party brands are trademarks of their respective owners.

All other brands are trademarks of a Medtronic company.

11/2018 US170542

VELOSORB™ FAST

Coated, Braided Synthetic Absorbable Sutures

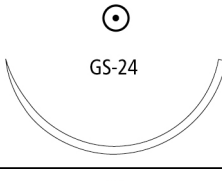
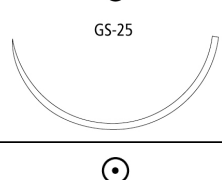
TAPER POINT									
Description	USP Size	EP Size	Length (in)	Length (cm)	Color	Units per box	Comments	Reorder code	
GS-21 1/2 CIRCLE 37mm  GS-21	3-0	2	30	75	UNDYED	36		CV-322	
	3-0	2	36	90	UNDYED	36		CV-944	
	2-0	3	30	75	UNDYED	36		CV-323	
	2-0	3	36	90	UNDYED	36		CV-945	
	0	3.5	30	75	UNDYED	36		CV-1324	
	0	3.5	36	90	UNDYED	36		CV-946	
GS-24 1/2 CIRCLE 40mm  GS-24	2-0	3	36	90	UNDYED	36		CV-9592	
	0	3.5	36	90	UNDYED	36		CV-9591	
	1	4	36	90	UNDYED	36		CV-9590	
GS-25 1/2 CIRCLE 48mm (Not to scale)  GS-25	2-0	3	36	90	UNDYED	36		CV-606	
	0	3.5	36	90	UNDYED	36		CV-604	
	1	4	36	90	UNDYED	36		CV-605	
GU-45 5/8 CIRCLE 37mm  GU-45	2-0	3	30	75	UNDYED	36		UV-412	
	1	4	36	90	UNDYED	36		UV-401	
GU-44 5/8 CIRCLE 40mm  GU-44	0	3.5	30	75	UNDYED	36		UV-1381	
	1	4	30	75	UNDYED	36		UV-1382	
ST-4 STRAIGHT 19mm  ST-4	4-0	1.5	30	75	UNDYED	36		CV-1673	

Surgipro™ II and Surgipro™ 7-0, 8-0; Sofsilik™ 8-0; Polysorb™, Biosyn™, Monosof™, Maxon™, Velosorb™ Fast sutures differ from USP and EP only in diameter. Please refer to IFU for more details.

© 2018 Medtronic. All rights reserved. Medtronic, Medtronic logo and Further, Together are trademarks of Medtronic.

™*Third party brands are trademarks of their respective owners.

All other brands are trademarks of a Medtronic company.

11/2018 US170542

VELOSORB™ FAST

Coated, Braided Synthetic Absorbable Sutures

HEAVY TAPER POINT								
Description	USP Size	EP Size	Length (in)	Length (cm)	Color	Units per box	Comments	Reorder code
HGS-20 1/2 CIRCLE 34mm 	1	4	36	90	UNDYED	36		CV-1696
	1	4	36	90	UNDYED	36		CV1696

Surgipro™ II and Surgipro™ 7-0, 8-0; Sofsilik™ 8-0; Polysorb™, Biosyn™, Monosof™, Maxon™, Velosorb™ Fast sutures differ from USP and EP only in diameter. Please refer to IFU for more details.

© 2018 Medtronic. All rights reserved. Medtronic, Medtronic logo and Further, Together are trademarks of Medtronic.















™*Third party brands are trademarks of their respective owners.

All other brands are trademarks of a Medtronic company.

11/2018 US170542

VELOSORB™ FAST

Coated, Braided Synthetic Absorbable Sutures

TAPERCUTTING									
Description		USP Size	EP Size	Length (in)	Length (cm)	Color	Units per box	Comments	Reorder code
KV-11 3/8 CIRCLE 13mm	 KV-11 	5-0	1	30	75	UNDYED	36		CV-2293
KV-15 3/8 CIRCLE 17mm	 KV-15 	4-0	1.5	18	45	UNDYED	12		CV-2275G
		4-0	1.5	30	75	UNDYED	36		CV-2279
		3-0	2	30	75	UNDYED	36		CV-2280
KV-5 1/2 CIRCLE 17mm	 KV-5 	3-0	2	30	75	UNDYED	12		CV-1674G
KV-7 1/2 CIRCLE 26mm	 KV-7 	3-0	2	30	75	UNDYED	12		CV-2003G
		2-0	3	36	90	UNDYED	36		CV-1002
KV-34 1/2 CIRCLE 37mm	 KV-34 	3-0	2	36	90	UNDYED	36		CV-916
		2-0	3	36	90	UNDYED	36		CV-917
		0	3.5	36	90	UNDYED	36		CV-919
		1	4	36	90	UNDYED	36		CV-918
KV-37 1/2 CIRCLE 40mm	 KV-37 	2-0	3	36	90	UNDYED	36		CV-2218
		0	3.5	36	90	UNDYED	36		CV-2217
		1	4	36	90	UNDYED	36		CV-2216
KV-40 1/2 CIRCLE 48mm (Not to scale)	 KV-40 	2-0	3	36	90	UNDYED	36		CV-7192
		2-0	3	36	90	UNDYED	36		CV7192
		0	3.5	36	90	UNDYED	36		CV-7191
		1	4	36	90	UNDYED	36		CV-7190

Surgipro™ II and Surgipro™ 7-0, 8-0; Sofsil™ 8-0; Polysorb™, Biosyn™, Monosof™, Maxon™, Velosorb™ Fast sutures differ from USP and EP only in diameter. Please refer to IFU for more details.

© 2018 Medtronic. All rights reserved. Medtronic, Medtronic logo and Further, Together are trademarks of Medtronic.

™*Third party brands are trademarks of their respective owners.

All other brands are trademarks of a Medtronic company.

11/2018 US170542

VELOSORB™ FAST

Coated, Braided Synthetic Absorbable Sutures

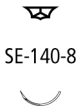
PREMIUM SPATULA									
Description	USP Size	EP Size	Length (in)	Length (cm)	Color	Units per box	Comments	Reorder code	
SE-140-8 3/8 CIRCLE 6.3mm	8-0	0.4	12	30	VIOLET	12		CV-501G	
	7-0	0.5	12	30	VIOLET	12		CV-500G	

PREMIUM CONVENTIONAL CUTTING									
Description	USP Size	EP Size	Length (in)	Length (cm)	Color	Units per box	Comments	Reorder code	
PC-10 3/8 CIRCLE 13mm	5-0	1	18	45	UNDYED	12		SV-834G	
	4-0	1.5	18	45	UNDYED	12		SV-835G	
PC-11 3/8 CIRCLE 16mm	6-0	0.7	30	75	UNDYED	12		SV-489G	
	5-0	1	18	45	UNDYED	12		SV-844G	
	4-0	1.5	18	45	UNDYED	12		SV-845G	
	4-0	1.5	30	75	UNDYED	12		SV-488G	
	3-0	2	30	75	UNDYED	12		SV-487G	

Surgipro™ II and Surgipro™ 7-0, 8-0; Sofsilik™ 8-0; Polysorb™, Biosyn™, Monosof™, Maxon™, Velosorb™ Fast sutures differ from USP and EP only in diameter. Please refer to IFU for more details.

© 2018 Medtronic. All rights reserved. Medtronic, Medtronic logo and Further, Together are trademarks of Medtronic.

™*Third party brands are trademarks of their respective owners.

All other brands are trademarks of a Medtronic company.

11/2018 US170542

VELOSORB™ FAST

Coated, Braided Synthetic Absorbable Sutures

Reorder Code	Page	Reorder Code	Page	Reorder Code	Page
CV-0046	8	CV-604	13	SV-2239	11
CV-0146	8	CV-605	13	SV-2240	11
CV-1002	15	CV-606	13	SV-2251	8
CV-1213	12	CV-7190	15	SV-2252	8
CV-1214	12	CV-7191	15	SV-2253	8
CV-1215	12	CV7192	15	SV-2285	8
CV-1324	13	CV-7192	15	SV-2286	8
CV-1673	13	CV8643	7	SV-2287	8
CV-1674G	15	CV-8643	7	SV-2289	8
CV1696	14	CV-8644	7	SV-2290	8
CV-1696	14	CV8653	7	SV-2294	8
CV-2003G	15	CV-8653	7	SV-2295	8
CV-2216	15	CV-8977	7	SV-2296	8
CV-2217	15	CV-8978	7	SV-2297	8
CV-2218	15	CV-8979	7	SV-2298	8
CV-2275G	15	CV-8980	7	SV-2299	8
CV-2279	15	CV9006G	7	SV-2910	8
CV-2280	15	CV-9006G	7	SV-2920	8
CV-2293	15	CV-9007G	7	SV-2930	8
CV-3100	12	CV-916	15	SV-32	10
CV-3110	12	CV-917	15	SV412	10
CV-3120	12	CV-918	15	SV-424	10
CV-318	12	CV-919	15	SV-425	10
CV-319	12	CV-931G	9	SV-426	10
CV-322	13	CV-932G	9	SV-439	10
CV-323	13	CV-944	13	SV-4431	8
CV-415	12	CV-945	13	SV-4550	9
CV-416G	12	CV-946	13	SV-487G	16
CV-417G	12	CV-947	13	SV-488G	16
CV-418	12	CV-9590	13	SV-4893	10
CV-4721	9	CV-9591	13	SV-489G	16
CV-4731	9	CV-9592	13	SV-493	10
CV-485	9	CV-9916G	12	SV-494	10
CV-486	9	CV-9936G	9	SV-496	10
CV-500G	16	CV-9975G	12	SV-496G	10
CV-501G	16	SV-1290	8	SV-497G	10
CV-55	12	SV1642	11	SV-6830	10
CV-56	12	SV-1642	11	SV-6840	10
CV-57	12	SV-2238	11	SV-834G	16

Surgipro™ II and Surgipro™ 7-0, 8-0; Sofsilik™ 8-0; Polysorb™, Biosyn™, Monosof™, Maxon™, Velosorb™ Fast sutures differ from USP and EP only in diameter. Please refer to IFU for more details.

© 2018 Medtronic. All rights reserved. Medtronic, Medtronic logo and Further, Together are trademarks of Medtronic.

™*Third party brands are trademarks of their respective owners.

All other brands are trademarks of a Medtronic company.

11/2018 US170542

VELOSORB™ FAST

Coated, Braided Synthetic Absorbable Sutures

Reorder Code	Page	Reorder Code	Page	Reorder Code	Page
SV-835G	16				
SV-844G	16				
SV-845G	16				
SV-935	10				
SV-9909G	11				
SV-9910G	11				
SV-9911G	11				
SV-9913	10				
SV-9915	10				
SV-9926	9				
SV-9927	9				
SV-9928	9				
SV-9937G	11				
SV-9938G	11				
SV-9940G	8				
SV-9941G	8				
SV-9943	11				
SV-9944G	11				
SV-9961G	9				
SVP-2251	10				
SVP-2285	10				
SVP-2294	10				
SVP-2295	10				
SVP-2296	10				
SVP-494	10				
UV-1381	13				
UV-1382	13				
UV-401	13				
UV-412	13				

Surgipro™ II and Surgipro™ 7-0, 8-0; Sofsilik™ 8-0; Polysorb™, Biosyn™, Monosof™, Maxon™, Velosorb™ Fast sutures differ from USP and EP only in diameter. Please refer to IFU for more details.

© 2018 Medtronic. All rights reserved. Medtronic, Medtronic logo and Further, Together are trademarks of Medtronic.

™*Third party brands are trademarks of their respective owners.

All other brands are trademarks of a Medtronic company.

11/2018 US170542

POLYSORB™

Lactomer™ 9 - 1, Coated, Braided Synthetic Absorbable Sutures

Description	Polysorb™ braided sutures are composed of Lactomer™ glycolide/lactide copolymer which is a synthetic polyester composed of glycolide and lactide (derived from glycolic and lactic acids). Polysorb™ sutures are prepared by coating the suture with a mixture of a caprolactone/glycolide copolymer and calcium stearoyl lactylate.
Indications	Polysorb™ sutures are indicated for use in soft tissue approximation or ligation and ophthalmic surgery, but not in cardiovascular or neural tissue.
Actions	Polysorb™ sutures elicit a minimal acute inflammatory reaction in tissue, which is followed by a gradual encapsulation of the suture by fibrous connective tissue. Progressive loss of tensile strength and eventual absorption of Polysorb™ sutures occurs by means of hydrolysis, where the Lactomer™ glycolide/lactide copolymer is broken down to glycolic and lactic acids which are subsequently absorbed and metabolized by the body.
Tensile Strength	Tensile strength averages for Polysorb™ sutures are approximately 140% of USP and E.P. minimum knot strength initially, are approximately 80% at two weeks and in excess of 30% at three weeks post implant.
Sterilization	Ethylene oxide.
Absorption	Absorption begins as a loss of tensile strength without appreciable loss of mass. Absorption of Polysorb™ sutures is essentially complete between the 56th and 70th day.
Packaging	Polysorb™ sutures are available in USP sizes 2 (5 Metric) through 8-0 (0.4 Metric). They are available undyed (natural) or violet colored. The sutures are supplied sterile, in pre-cut lengths and ligating reels, non-needled or affixed to various needle types using both permanent and removable needle attachment techniques. Please refer to the individual package IFUs for complete instructions, indications, contraindications, warnings and precautions.

POLYSORB™

Lactomer™ 9 - 1, Coated, Braided Synthetic Absorbable Sutures

NON NEEDLED - PRE-CUT								
Description	USP Size	EP Size	Length (in)	Length (cm)	Color	Units per box	Comments	Reorder code
PRE-CUT	4-0	1.5	18	45	VIOLET	36	3 strands	L-71
	4-0	1.5	18	45	VIOLET	24	12 strands	L-11
	4-0	1.5	18	45	VIOLET	24	6 strands	L-20
	4-0	1.5	18	45	UNDYED	24	12 strands	L-1-
	3-0	2	18	45	UNDYED	24	12 strands	L-2-
	3-0	2	18	45	VIOLET	24	12 strands	L-12
	3-0	2	18	45	VIOLET	24	6 strands	L-22
	3-0	2	18	45	VIOLET	36	3 strands	L-72
	3-0	2	24	60	VIOLET	24	12 strands	L-32
	3-0	2	30	75	VIOLET	24	3 strands	L-402
	3-0	2	30	75	VIOLET	24	6 strands	L-38
	2-0	3	18	45	VIOLET	24	6 strands	L-23
	2-0	3	18	45	VIOLET	36	3 strands	L-73
	2-0	3	18	45	UNDYED	24	12 strands	L-3
	2-0	3	18	45	VIOLET	24	12 strands	L-13-
	2-0	3	24	60	VIOLET	24	12 strands	L-33
	2-0	3	30	75	UNDYED	24	12 strands	L-43
	2-0	3	30	75	VIOLET	24	3 strands	L-403
	2-0	3	30	75	VIOLET	24	6 strands	L-39
	0	3.5	18	45	VIOLET	24	12 strands	L-27
	0	3.5	18	45	UNDYED	24	12 strands	L-24
	0	3.5	18	45	VIOLET	36	3 strands	L-74
	0	3.5	18	45	VIOLET	24	6 strands	L-14
	0	3.5	18	45	UNDYED	24	6 strands	L-4
	0	3.5	24	60	VIOLET	24	12 strands	L-34
	0	3.5	30	75	VIOLET	24	6 strands	L-40
	0	3.5	30	75	VIOLET	24	3 strands	L-404
	2	5	18	45	UNDYED	24	12 strands	L-26
	2	5	18	45	VIOLET	36	3 strands	L-76
	2	5	18	45	VIOLET	24	12 strands	L-28
	2	5	30	75	VIOLET	24	6 strands	L-42
	2	5	30	75	VIOLET	24	3 strands	L-406
	1	4	18	45	VIOLET	36	3 strands	L-75
	1	4	18	45	UNDYED	24	6 strands	L-5
	1	4	18	45	VIOLET	24	6 strands	L-15
	1	4	18	45	VIOLET	24	12 strands	L-35
	1	4	18	45	UNDYED	24	12 strands	L-25
	1	4	24	60	VIOLET	24	12 strands	L-36
	1	4	30	75	VIOLET	24	3 strands	L-405
	1	4	30	75	VIOLET	24	6 strands	L-41

Surgipro™ II and Surgipro™ 7-0, 8-0; Sofsilik™ 8-0; Polysorb™, Biosyn™, Monosof™, Maxon™, Velosorb™ Fast sutures differ from USP and EP only in diameter. Please refer to IFU for more details.

© 2018 Medtronic. All rights reserved. Medtronic, Medtronic logo and Further, Together are trademarks of Medtronic.

™*Third party brands are trademarks of their respective owners.

All other brands are trademarks of a Medtronic company.

11/2018 US170542

POLYSORB™

Lactomer™ 9 - 1, Coated, Braided Synthetic Absorbable Sutures

NON NEEDED - STANDARD LENGTH								
Description	USP Size	EP Size	Length (in)	Length (cm)	Color	Units per box	Comments	Reorder code
STANDARD LENGTH	4-0	1.5	60	150	VIOLET	36	Standard Length	L-111
	3-0	2	60	150	UNDYED	36	Standard Length	L-102
	3-0	2	60	150	VIOLET	36	Standard Length	L-112
	2-0	3	60	150	UNDYED	36	Standard Length	L-103
	2-0	3	60	150	VIOLET	36	Standard Length	L113
	0	3.5	60	150	VIOLET	36	Standard Length	L-114
	0	3.5	60	150	UNDYED	36	Standard Length	L-104
	2	5	60	150	VIOLET	36	Standard Length	L-116
	1	4	60	150	VIOLET	36	Standard Length	L-115

NON NEEDED - REEL								
Description	USP Size	EP Size	Length (in)	Length (cm)	Color	Units per box	Comments	Reorder code
REEL	4-0	1.5	60	150	UNDYED	24		LL-101
	4-0	1.5	60	150	VIOLET	24		LL-111
	4-0	1.5	98	250	VIOLET	24		LL-221
	3-0	2	60	150	VIOLET	24		LL-112
	3-0	2	60	150	UNDYED	24		LL-102
	3-0	2	98	250	VIOLET	24		LL-222
	3-0	2	98	250	UNDYED	24		LL-322
	2-0	3	60	150	UNDYED	24		LL-103
	2-0	3	60	150	VIOLET	24		LL113
	2-0	3	98	250	VIOLET	24		LL-223
	2-0	3	98	250	UNDYED	24		LL-323
	2-0	3	144	366	VIOLET	24		LL-233
	0	3.5	60	150	VIOLET	24		LL-114
	0	3.5	60	150	UNDYED	24		LL-104
	0	3.5	98	250	VIOLET	24		LL-224
	2	5	60	150	VIOLET	24		LL-116
	2	5	98	250	VIOLET	24		LL-226
	1	4	60	150	VIOLET	24		LL-115
	1	4	98	250	VIOLET	24		LL-225

Surgipro™ II and Surgipro™ 7-0, 8-0; Sofsilik™ 8-0; Polysorb™, Biosyn™, Monosof™, Maxon™, Velosorb™ Fast sutures differ from USP and EP only in diameter. Please refer to IFU for more details.

© 2018 Medtronic. All rights reserved. Medtronic, Medtronic logo and Further, Together are trademarks of Medtronic.





™*Third party brands are trademarks of their respective owners.

All other brands are trademarks of a Medtronic company.

11/2018 US170542

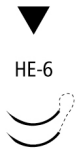
POLYSORB™

Lactomer™ 9 - 1, Coated, Braided Synthetic Absorbable Sutures

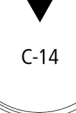
REVERSE CUTTING								
Description	USP Size	EP Size	Length (in)	Length (cm)	Color	Units per box	Comments	Reorder code
HE-6 - HE-6 3/8 CIRCLE 7.4mm (Double armed) 	6-0	0.7	18	45	VIOLET	12	Surgalloy™	L-1551-K
C-1 3/8 CIRCLE 12mm 	6-0	0.7	18	45	UNDYED	36		SL-171
	5-0	1	18	45	UNDYED	36	Reliapro™needle	SL-172
HE-3 - HE-3 3/8 CIRCLE 13mm (Double armed) 	5-0	1	12	30	UNDYED	12	Surgalloy™	L-4323K
C-12 3/8 CIRCLE 16mm 	5-0	1	30	75	VIOLET	36	Reliapro™needle	SL-630
	4-0	1.5	30	75	UNDYED	36	Reliapro™needle	SL-605
	4-0	1.5	30	75	VIOLET	36	Reliapro™needle	SL-607
	3-0	2	30	75	VIOLET	36	Reliapro™needle	SL-608
C-13 3/8 CIRCLE 19mm 	5-0	1	18	45	UNDYED	36	Reliapro™needle	SL-639
	5-0	1	30	75	VIOLET	36	Reliapro™needle	SL-634
	5-0	1	30	75	UNDYED	36	Reliapro™needle	SL-690
	4-0	1.5	18	45	UNDYED	12	Reliapro™needle	SL-638
	4-0	1.5	30	75	UNDYED	36	Reliapro™needle	SL-691
	4-0	1.5	30	75	VIOLET	36	Reliapro™needle	SL-635
	4-0	1.5	30	75	VIOLET	12	Reliapro™needle	SL-635G
	4-0	1.5	30	75	UNDYED	12	Reliapro™needle	SL-691G
	3-0	2	18	45	UNDYED	36	Reliapro™needle	SL-637
	3-0	2	30	75	VIOLET	36	Reliapro™needle	SL-636
	3-0	2	30	75	UNDYED	36	Reliapro™needle	SL-822
	3-0	2	30	75	UNDYED	12	Reliapro™needle	SL-822G
C-14 3/8 CIRCLE 24mm 	4-0	1.5	30	75	VIOLET	36	Reliapro™needle	SL-695
	4-0	1.5	30	75	UNDYED	36	Reliapro™needle	SL-692
	3-0	2	30	75	VIOLET	36	Reliapro™needle	SL-694
	3-0	2	30	75	UNDYED	36	Reliapro™needle	SL-693
	2-0	3	30	75	UNDYED	36	Reliapro™needle	SL-823
	2-0	3	30	75	VIOLET	36	Reliapro™needle	CL-823

Surgipro™ II and Surgipro™ 7-0, 8-0; Sofsilik™ 8-0; Polysorb™, Biosyn™, Monosof™, Maxon™, Velosorb™ Fast sutures differ from USP and EP only in diameter. Please refer to IFU for more details.

© 2018 Medtronic. All rights reserved. Medtronic, Medtronic logo and Further, Together are trademarks of Medtronic.

™*Third party brands are trademarks of their respective owners.

All other brands are trademarks of a Medtronic company.

11/2018 US170542

POLYSORB™

Lactomer™ 9 - 1, Coated, Braided Synthetic Absorbable Sutures

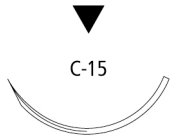
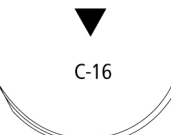
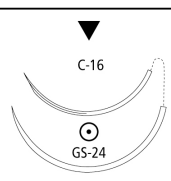
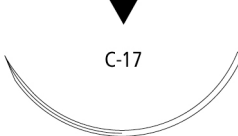
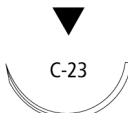
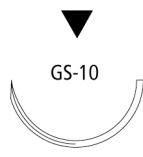
REVERSE CUTTING									
Description	USP Size	EP Size	Length (in)	Length (cm)	Color	Units per box	Comments	Reorder code	
C-15 3/8 CIRCLE 26mm 	3-0	2	18	45	UNDYED	12	5 strands, D-Tach™, Reliapoint™needle	SL-73-MG	
	2-0	3	30	75	UNDYED	36	Reliapoint™needle	SL-586	
	0	3.5	30	75	UNDYED	36	Reliapoint™needle	SL-587	
C-16 3/8 CIRCLE 30mm 	3-0	2	30	75	UNDYED	36	Reliapoint™needle	SL-696	
	2-0	3	30	75	VIOLET	36	Reliapoint™needle	SL-714	
	2-0	3	30	75	UNDYED	36	Reliapoint™needle	SL-611	
	0	3.5	36	90	VIOLET	36	Reliapoint™needle	SL-712	
C-16 - GS-24 3/8 CIRCLE 30mm (Double armed) (Not to scale) 	3-0	2	60	150	UNDYED	36	Reliapoint™needle	CL-976	
	2-0	3	60	150	UNDYED	36	Reliapoint™needle	CL-977	
C-17 3/8 CIRCLE 39mm 	2-0	3	30	75	UNDYED	36	Reliapoint™needle	SL-674	
	2	5	36	90	UNDYED	36	Reliapoint™needle	SL-675	
C-23 1/2 CIRCLE 24mm 	3-0	2	18	45	VIOLET	12	5 strands, D-Tach™, Reliapoint™needle	SL-83-MG	
	3-0	2	18	45	UNDYED	12	5 strands, D-Tach™, Reliapoint™needle	SL-85-MG	
	3-0	2	18	45	UNDYED	36	Reliapoint™needle	CL-85	
	3-0	2	30	75	UNDYED	36	Reliapoint™needle	SL-613	
	3-0	2	30	75	VIOLET	36	Reliapoint™needle	SL-632	
	2-0	3	30	75	VIOLET	36	Reliapoint™needle	SL-631	
	2-0	3	30	75	UNDYED	36	Reliapoint™needle	SL-612	
GS-10 1/2 CIRCLE 26mm 	3-0	2	18	45	UNDYED	12	5 strands, D-Tach™	CL-53MG	
	3-0	2	30	75	UNDYED	36		CL-868	
	2-0	3	18	45	UNDYED	12	5 strands, D-Tach™	CL-52-MG	
	2-0	3	30	75	VIOLET	36		CL-769	
	2-0	3	30	75	UNDYED	36		CL-869	
	0	3.5	30	75	UNDYED	36		CL-870	
	1	4	30	75	UNDYED	36		CL-867	

Surgipro™ II and Surgipro™ 7-0, 8-0; Sofsilik™ 8-0; Polysorb™, Biosyn™, Monosof™, Maxon™, Velosorb™ Fast sutures differ from USP and EP only in diameter. Please refer to IFU for more details.

© 2018 Medtronic. All rights reserved. Medtronic, Medtronic logo and Further, Together are trademarks of Medtronic.



™*Third party brands are trademarks of their respective owners.

All other brands are trademarks of a Medtronic company.

11/2018 US170542

POLYSORB™

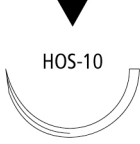
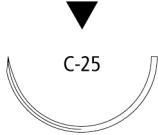
Lactomer™ 9 - 1, Coated, Braided Synthetic Absorbable Sutures

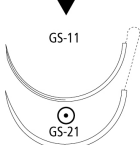
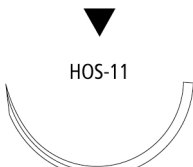
REVERSE CUTTING									
Description	USP Size	EP Size	Length (in)	Length (cm)	Color	Units per box	Comments	Reorder code	
HOS-10 1/2 CIRCLE 26mm 	2-0	3	18	45	UNDYED	12	5 strands, D-Tach™	CL-354-MG	
	2-0	3	18	45	VIOLET	12	3 strands, D-Tach™	CL-356-MG	
	0	3.5	18	45	UNDYED	12	3 strands, D-Tach™	CL-355-MG	
	0	3.5	18	45	UNDYED	12	5 strands, D-Tach™	CL-55-MG	
	2	5	30	75	VIOLET	36		CL-552	
	1	4	18	45	VIOLET	12	3 strands, D-Tach™	CL-358-MG	
	1	4	30	75	VIOLET	36		CL-547	
	1	4	30	75	UNDYED	36		CL-581	
C-25 1/2 CIRCLE 30mm 	2-0	3	30	75	VIOLET	36	Reliappoint™needle	SL-622	
	0	3.5	36	90	UNDYED	36	Reliappoint™needle	SL-721	
	1	4	36	90	VIOLET	36	Reliappoint™needle	SL-722	
GS-11 1/2 CIRCLE 37mm 	3-0	2	30	75	UNDYED	36		CL-542	
	3-0	2	30	75	VIOLET	36		CL-815	
	2-0	3	30	75	VIOLET	36		CL-816	
	2-0	3	30	75	UNDYED	36		CL-543	
	2-0	3	36	90	VIOLET	36		CL-916	
	0	3.5	30	75	UNDYED	36		CL-544	
	0	3.5	30	75	VIOLET	36		CL-817	
	0	3.5	36	90	UNDYED	36		CL-534	
	0	3.5	36	90	VIOLET	36		CL-917	
	2	5	36	90	UNDYED	36		CL-533	
	2	5	36	90	VIOLET	36		CL-919	
	1	4	30	75	VIOLET	36		CL-818	
	1	4	30	75	UNDYED	36		CL-545	
	1	4	36	90	VIOLET	36		CL-918	
	GS-11 - GS-21 1/2 CIRCLE 37mm (Double armed) (Not to scale) 	3-0	2	60	150	VIOLET	36		CL-982
2-0		3	60	150	VIOLET	36		CL-992	
HOS-11 1/2 CIRCLE 37mm 	2-0	3	18	45	VIOLET	12	3 strands, D-Tach™	CL-369-MG	
	2-0	3	18	45	UNDYED	12	3 strands, D-Tach™	CL-374-MG	
	2-0	3	30	75	UNDYED	36		CL-536	
	2-0	3	30	75	VIOLET	36		CL-526	
	0	3.5	18	45	UNDYED	12	3 strands, D-Tach™	CL-375-MG	
	0	3.5	18	45	VIOLET	12	3 strands, D-Tach™	CL-370-MG	
	0	3.5	30	75	UNDYED	36		CL-537	
	1	4	30	75	UNDYED	36		CL-538	
	1	4	30	75	VIOLET	36		CL-528	

Surgipro™ II and Surgipro™ 7-0, 8-0; Sofsilik™ 8-0; Polysorb™, Biosyn™, Monosof™, Maxon™, Velosorb™ Fast sutures differ from USP and EP only in diameter. Please refer to IFU for more details.

© 2018 Medtronic. All rights reserved. Medtronic, Medtronic logo and Further, Together are trademarks of Medtronic.



™*Third party brands are trademarks of their respective owners.

All other brands are trademarks of a Medtronic company.

11/2018 US170542

POLYSORB™

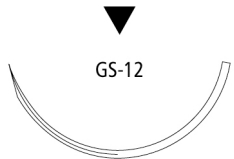
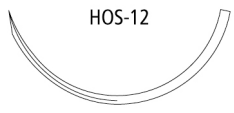
Lactomer™ 9 - 1, Coated, Braided Synthetic Absorbable Sutures

REVERSE CUTTING								
Description	USP Size	EP Size	Length (in)	Length (cm)	Color	Units per box	Comments	Reorder code
GS-12 1/2 CIRCLE 40mm 	2-0	3	30	75	UNDYED	36		CL-595
	2-0	3	30	75	VIOLET	36		CL-833
	0	3.5	30	75	UNDYED	36		CL-596
	0	3.5	30	75	VIOLET	36		CL-804
	0	3.5	36	90	VIOLET	36		CL-933
	2	5	36	90	VIOLET	36		CL-937
	1	4	30	75	VIOLET	36		CL-805
	1	4	30	75	UNDYED	36		CL-597
	1	4	36	90	VIOLET	36		CL-936
HOS-12 1/2 CIRCLE 40mm 	2-0	3	18	45	VIOLET	12	3 strands, D-Tach™	CL-382-MG
	0	3.5	18	45	UNDYED	12	3 strands, D-Tach™	CL-376-MG
	0	3.5	18	45	VIOLET	12	3 strands, D-Tach™	CL-380-MG
	2	5	18	45	VIOLET	12	3 strands, D-Tach™	CL-383-MG
	1	4	18	45	VIOLET	12	3 strands, D-Tach™	CL-381-MG
	1	4	18	45	UNDYED	12	3 strands, D-Tach™	CL-377-MG
	1	4	30	75	VIOLET	12	5 strands, D-Tach™	CL-97-MG
GS-13 1/2 CIRCLE 48mm (Not to scale) 	0	3.5	30	75	VIOLET	36		CL-568
	0	3.5	30	75	UNDYED	36		CL-554
	0	3.5	36	90	VIOLET	36		CL-927
	2	5	30	75	VIOLET	36		CL-570
	2	5	36	90	UNDYED	36		CL-939
	2	5	36	90	VIOLET	36		CL-929
	1	4	30	75	VIOLET	36		CL-569
	1	4	30	75	UNDYED	36		CL-555
	1	4	36	90	VIOLET	36		CL-928
HOS-14 1/2 CIRCLE 55mm (Not to scale) 	2	5	30	75	VIOLET	36		CL-979

Surgipro™ II and Surgipro™ 7-0, 8-0; Sofsilik™ 8-0; Polysorb™, Biosyn™, Monosof™, Maxon™, Velosorb™ Fast sutures differ from USP and EP only in diameter. Please refer to IFU for more details.

© 2018 Medtronic. All rights reserved. Medtronic, Medtronic logo and Further, Together are trademarks of Medtronic.





™*Third party brands are trademarks of their respective owners.

All other brands are trademarks of a Medtronic company.

11/2018 US170542

POLYSORB™

Lactomer™ 9 - 1, Coated, Braided Synthetic Absorbable Sutures

PREMIUM REVERSE CUTTING								
Description	USP Size	EP Size	Length (in)	Length (cm)	Color	Units per box	Comments	Reorder code
P-10 3/8 CIRCLE 11mm 	7-0	0.5	18	45	UNDYED	12	Edgellant™ needle, Surgalloy™ alloy	SL-1624G
	6-0	0.7	18		UNDYED	12	Edgellant™ needle, Surgalloy™ alloy	SL1625G
	6-0	0.7	18	45	UNDYED	36	Edgellant™ needle, Surgalloy™ alloy	SL-1625
	5-0	1	18	45	UNDYED	36	Edgellant™ needle, Surgalloy™ alloy	SL-1689
	5-0	1	18	45	UNDYED	12	Edgellant™ needle, Surgalloy™ alloy	SL-1689G
P-13 3/8 CIRCLE 13mm 	6-0	0.7	18	45	UNDYED	12	Edgellant™ needle, Surgalloy™ alloy	SL-5688-G
	6-0	0.7	18	45	UNDYED	36	Edgellant™ needle, Surgalloy™ alloy	SL-5688
	5-0	1	18	45	UNDYED	36	Edgellant™ needle, Surgalloy™ alloy	SL-5687
	5-0	1	18	45	UNDYED	12	Edgellant™ needle, Surgalloy™ alloy	SL-5687G
	4-0	1.5	18	45	UNDYED	12	Edgellant™ needle, Surgalloy™ alloy	SL-5691G
	4-0	1.5	18	45	UNDYED	36	Edgellant™ needle, Surgalloy™ alloy	SL-5690
P-11 3/8 CIRCLE 16mm 	5-0	1	18	45	UNDYED	36	Edgellant™ needle, Surgalloy™ alloy	SL-5626
	4-0	1.5	18	45	UNDYED	36	Edgellant™ needle, Surgalloy™ alloy	SL-5686
	4-0	1.5	18	45	UNDYED	12	Edgellant™ needle, Surgalloy™ alloy	SL-5686G
	4-0	1.5	30	75	UNDYED	36	Edgellant™ needle, Surgalloy™ alloy	SL-5620
	3-0	2	30	75	UNDYED	36	Edgellant™ needle, Surgalloy™ alloy	SL-5621
P-12 3/8 CIRCLE 19mm 	5-0	1	18	45	UNDYED	36	Edgellant™ needle, Surgalloy™ alloy	SL-5636
	5-0	1	18	45	UNDYED	12	Edgellant™ needle, Surgalloy™ alloy	SL-5636-G
	4-0	1.5	18	45	VIOLET	36	Edgellant™ needle, Surgalloy™ alloy	SL-5629
	4-0	1.5	18	45	UNDYED	12	Edgellant™ needle, Surgalloy™ alloy	SL-5627-G
	4-0	1.5	18	45	UNDYED	36	Edgellant™ needle, Surgalloy™ alloy	SL-5627
	4-0	1.5	30	75	UNDYED	36	Edgellant™ needle, Surgalloy™ alloy	SL-5637
	3-0	2	18	45	UNDYED	36	Edgellant™ needle, Surgalloy™ alloy	SL-5628
	3-0	2	18	45	UNDYED	12	Edgellant™ needle, Surgalloy™ alloy	SL-5628G
	3-0	2	30	75	UNDYED	36	Edgellant™ needle, Surgalloy™ alloy	SL-5638

Surgipro™ II and Surgipro™ 7-0, 8-0; Sofsil™ 8-0; Polysorb™, Biosyn™, Monosof™, Maxon™, Velosorb™ Fast sutures differ from USP and EP only in diameter. Please refer to IFU for more details.

© 2018 Medtronic. All rights reserved. Medtronic, Medtronic logo and Further, Together are trademarks of Medtronic.





™*Third party brands are trademarks of their respective owners.

All other brands are trademarks of a Medtronic company.

11/2018 US170542

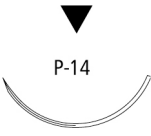
POLYSORB™

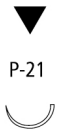
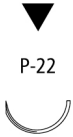
Lactomer™ 9 - 1, Coated, Braided Synthetic Absorbable Sutures

PREMIUM REVERSE CUTTING								
Description	USP Size	EP Size	Length (in)	Length (cm)	Color	Units per box	Comments	Reorder code
P-14 3/8 CIRCLE 24mm 	4-0	1.5	18	45	UNDYED	36	Edgellant™ needle, Surgalloy™ alloy	SL-5641
	4-0	1.5	18	45	UNDYED	12	Edgellant™ needle, Surgalloy™ alloy	SL-5641G
	4-0	1.5	30	75	UNDYED	36	Edgellant™ needle, Surgalloy™ alloy	SL-5678
	3-0	2	18	45	UNDYED	36	Edgellant™ needle, Surgalloy™ alloy	SL-5640
	3-0	2	18	45	UNDYED	12	Edgellant™ needle, Surgalloy™ alloy	SL-5640G
	3-0	2	30	75	UNDYED	36	Edgellant™ needle, Surgalloy™ alloy	SL-5679
	3-0	2	30	75	UNDYED	12	Edgellant™ needle, Surgalloy™ alloy	SL-5679G
	2-0	3	30	75	UNDYED	36	Edgellant™ needle, Surgalloy™ alloy	SL-5680
P-17 3/8 CIRCLE 30mm 	2-0	3	30	75	UNDYED	36	Edgellant™ needle, Surgalloy™ alloy	SL-1596
P-21 1/2 CIRCLE 9mm 	6-0	0.7	18	45	UNDYED	12	Edgellant™ needle, Surgalloy™ alloy	SL-1510G
	5-0	1	18		UNDYED	12	Edgellant™ needle, Surgalloy™ alloy	SL1644G
	4-0	1.5	18	45	UNDYED	12	Edgellant™ needle, Surgalloy™ alloy	SL-1645G
P-22 1/2 CIRCLE 13mm 	6-0	0.7	18	45	UNDYED	36	Edgellant™ needle, Surgalloy™ alloy	SL-1613
	5-0	1	18	45	UNDYED	12	Edgellant™ needle, Surgalloy™ alloy	SL-1614G
	5-0	1	18	45	UNDYED	36	Edgellant™ needle, Surgalloy™ alloy	SL-1614
	4-0	1.5	18	45	UNDYED	36	Edgellant™ needle, Surgalloy™ alloy	SL-1615
P-24 1/2 CIRCLE 16mm 	5-0	1	18	45	UNDYED	12	Edgellant™ needle, Surgalloy™ alloy	SL-5632G
	5-0	1	18	45	UNDYED	36	Edgellant™ needle, Surgalloy™ alloy	SL-5632
	4-0	1.5	18	45	UNDYED	36	Edgellant™ needle, Surgalloy™ alloy	SL-5633
	4-0	1.5	18	45	UNDYED	12	Edgellant™ needle, Surgalloy™ alloy	SL-5633G

Surgipro™ II and Surgipro™ 7-0, 8-0; Sofsilik™ 8-0; Polysorb™, Biosyn™, Monosof™, Maxon™, Velosorb™ Fast sutures differ from USP and EP only in diameter. Please refer to IFU for more details.

© 2018 Medtronic. All rights reserved. Medtronic, Medtronic logo and Further, Together are trademarks of Medtronic.

™*Third party brands are trademarks of their respective owners.

All other brands are trademarks of a Medtronic company.

11/2018 US170542

POLYSORB™

Lactomer™ 9 - 1, Coated, Braided Synthetic Absorbable Sutures

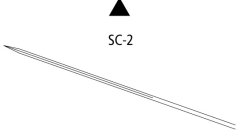
CONVENTIONAL CUTTING								
Description	USP Size	EP Size	Length (in)	Length (cm)	Color	Units per box	Comments	Reorder code
SC-2 STRAIGHT 60mm (Not to scale) 	4-0	1.5	30	75	VIOLET	36		SL-654
	4-0	1.5	30	75	UNDYED	36		SL-644
	3-0	2	30	75	UNDYED	36		SL-643
	3-0	2	30	75	VIOLET	36		SL-653
	2-0	3	30	75	UNDYED	36		SL-642
	2-0	3	30	75	VIOLET	36		SL-652

Surgipro™ II and Surgipro™ 7-0, 8-0; Sofsilik™ 8-0; Polysorb™, Biosyn™, Monosof™, Maxon™, Velosorb™ Fast sutures differ from USP and EP only in diameter. Please refer to IFU for more details.

© 2018 Medtronic. All rights reserved. Medtronic, Medtronic logo and Further, Together are trademarks of Medtronic.





™*Third party brands are trademarks of their respective owners.

All other brands are trademarks of a Medtronic company.

11/2018 US170542

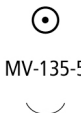
POLYSORB™

Lactomer™ 9 - 1, Coated, Braided Synthetic Absorbable Sutures

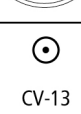
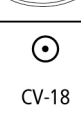
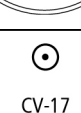
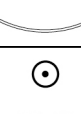
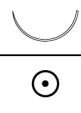
TAPER POINT									
Description	USP Size	EP Size	Length (in)	Length (cm)	Color	Units per box	Comments	Reorder code	
MV-135-5 3/8 CIRCLE 6mm MV-135-5 	8-0	0.4	5	13	VIOLET	12	Surgalloy™	L-2800	
CV-11 3/8 CIRCLE 13mm CV-11 	5-0	1	30	75	VIOLET	36		GL-890	
CVF-11 3/8 CIRCLE 13mm CVF-11 	6-0	0.7	30	75	VIOLET	36	Surgalloy™, Sulzle needle	GL889-2	
	6-0	0.7	30	75	VIOLET	36	Surgalloy™, Sulzle needle	GL-889-2	
CV-15 3/8 CIRCLE 17mm CV-15 	4-0	1.5	30	75	VIOLET	36		GL-881	
	3-0	2	30	75	VIOLET	36		GL-882	
CV-13 3/8 CIRCLE 22mm CV-13 	4-0	1.5	30	75	VIOLET	36		CL-304	
	3-0	2	30	75	VIOLET	36		GL-303	
	2-0	3	30	75	VIOLET	36		GL-302	
CV-18 3/8 CIRCLE 26mm CV-18 	2-0	3	30	75	VIOLET	36		CL-457	
CV-17 3/8 CIRCLE 32mm CV-17 	3-0	2	30	75	VIOLET	36		GL-522	
	2-0	3	30	75	VIOLET	36		GL-523	
	0	3.5	30	75	VIOLET	36		GL-524	
CVF-21 1/2 CIRCLE 12mm CVF-21 	6-0	0.7	18	45	UNDYED	36	Surgalloy™	UL-101	
	6-0	0.7	18	45	VIOLET	36	Surgalloy™	UL-102	
	5-0	1	18	45	UNDYED	36	Surgalloy™	SL-432	
	4-0	1.5	18	45	UNDYED	36		SL-431	
CV-22 1/2 CIRCLE 13mm CV-22 	5-0	1	18	45	VIOLET	12	5 strands, D-Tach™	GL-45-MG	
	5-0	1	30	75	UNDYED	36		GL-885	
	4-0	1.5	18	45	VIOLET	12	5 strands, D-Tach™	GL-44-MG	
	4-0	1.5	18	45	VIOLET	12	5 strands, D-Tach™	GLJ-54-M	
	4-0	1.5	30	75	UNDYED	36		GL-884	
	4-0	1.5	30	75	VIOLET	36		CL-782	

Surgipro™ II and Surgipro™ 7-0, 8-0; Sofsilik™ 8-0; Polysorb™, Biosyn™, Monosof™, Maxon™, Velosorb™ Fast sutures differ from USP and EP only in diameter. Please refer to IFU for more details.

© 2018 Medtronic. All rights reserved. Medtronic, Medtronic logo and Further, Together are trademarks of Medtronic.



™*Third party brands are trademarks of their respective owners.

All other brands are trademarks of a Medtronic company.

11/2018 US170542

POLYSORB™

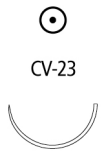
Lactomer™ 9 - 1, Coated, Braided Synthetic Absorbable Sutures

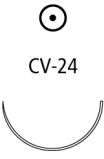
TAPER POINT									
Description	USP Size	EP Size	Length (in)	Length (cm)	Color	Units per box	Comments	Reorder code	
CV-23 1/2 CIRCLE 17mm 	5-0	1	30	75	UNDYED	36		UL-213	
	5-0	1	30	75	VIOLET	36		UL-202	
	4-0	1.5	18	45	UNDYED	12	5 strands, D-Tach™	UL-46-MG	
	4-0	1.5	18	45	UNDYED	12	5 strands, D-Tach™	ULJ-56-M	
	4-0	1.5	18	45	VIOLET	12	5 strands, D-Tach™	GL-46-MG	
	4-0	1.5	18	45	VIOLET	12	5 strands, D-Tach™	GLJ-56-M	
	4-0	1.5	30	75	UNDYED	36		UL-212	
	4-0	1.5	30	75	VIOLET	36	Surgalloy™	UL-303	
	3-0	2	18	45	UNDYED	12	5 strands, D-Tach™	UL-47-MG	
	3-0	2	18	45	VIOLET	12	5 strands, D-Tach™	GL-47-MG	
	3-0	2	18	45	VIOLET	12	5 strands, D-Tach™	GLJ-57-M	
	3-0	2	30	75	UNDYED	36		UL-215	
	3-0	2	30	75	VIOLET	36		UL-204	
	2-0	3	30	75	VIOLET	36		UL-205	
CVF-23 1/2 CIRCLE 17mm 	6-0	0.7	30	75	VIOLET	36	Surgalloy™, Sulzle needle	UL-201-2	
	4-0	1.5	30	75	UNDYED	36	Surgalloy™	UL-214	
	4-0	1.5	30	75	VIOLET	36	Surgalloy™	UL-203	
CVF-23 - CVF-23 1/2 CIRCLE 17mm (Double armed) 	4-0	1.5	36	90	VIOLET	36	Surgalloy™	CL-219	
CV-24 1/2 CIRCLE 20mm 	4-0	1.5	30	75	VIOLET	36		CL-460	
	3-0	2	30	75	VIOLET	36		CL-461	
	2-0	3	30	75	VIOLET	36		CL-462	

Surgipro™ II and Surgipro™ 7-0, 8-0; Sofsilik™ 8-0; Polysorb™, Biosyn™, Monosof™, Maxon™, Velosorb™ Fast sutures differ from USP and EP only in diameter. Please refer to IFU for more details.

© 2018 Medtronic. All rights reserved. Medtronic, Medtronic logo and Further, Together are trademarks of Medtronic.



™*Third party brands are trademarks of their respective owners.

All other brands are trademarks of a Medtronic company.

11/2018 US170542

POLYSORB™

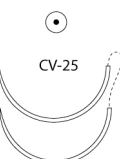
Lactomer™ 9 - 1, Coated, Braided Synthetic Absorbable Sutures

TAPER POINT									
Description	USP Size	EP Size	Length (in)	Length (cm)	Color	Units per box	Comments	Reorder code	
CV-25 1/2 CIRCLE 22mm 	4-0	1.5	18	45	VIOLET	12	5 strands, D-Tach™	GL-34-MG	
	4-0	1.5	18	45	VIOLET	12	5 strands, D-Tach™	GLJ-51-M	
	4-0	1.5	30	75	UNDYED	36		GL-191	
	4-0	1.5	30	75	VIOLET	36		GL-181	
	3-0	2	18	45	VIOLET	12	5 strands, D-Tach™	GL-33-MG	
	3-0	2	18	45	VIOLET	12	5 strands, D-Tach™	GLJ-50-M	
	3-0	2	30	75	VIOLET	12	5 strands, D-Tach™	GL-182-M	
	3-0	2	30	75	UNDYED	36		GL-192	
	3-0	2	30	75	VIOLET	36		GL-182	
	3-0	2	48	120	VIOLET	24	Endoscopy suture	EL-440	
	2-0	3	18	45	VIOLET	12	5 strands, D-Tach™	GL-32-MG	
	2-0	3	30	75	VIOLET	36		GL-183	
CV-25 - CV-25 1/2 CIRCLE 22mm (Double armed) 	3-0	2	36	90	VIOLET	36		GL-282	
GS-23 1/2 CIRCLE 22mm 	3-0	2	30	75	VIOLET	36		CL-892	
	2-0	3	18	45	UNDYED	12	5 strands, D-Tach™	CL-42-MG	
	2-0	3	30	75	VIOLET	36		CL-893	
	0	3.5	30	75	VIOLET	36		CL-894	
CV-305 1/2 CIRCLE 25mm 	3-0	2	18	45	UNDYED	12		GL79MG	
	2-0	3	18	45	VIOLET	12		GL72MG	

Surgipro™ II and Surgipro™ 7-0, 8-0; Sofsilik™ 8-0; Polysorb™, Biosyn™, Monosof™, Maxon™, Velosorb™ Fast sutures differ from USP and EP only in diameter. Please refer to IFU for more details.

© 2018 Medtronic. All rights reserved. Medtronic, Medtronic logo and Further, Together are trademarks of Medtronic.

™*Third party brands are trademarks of their respective owners.

All other brands are trademarks of a Medtronic company.

11/2018 US170542

POLYSORB™

Lactomer™ 9 - 1, Coated, Braided Synthetic Absorbable Sutures

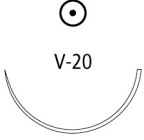
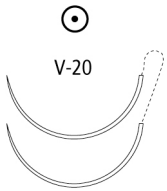
TAPER POINT								
Description	USP Size	EP Size	Length (in)	Length (cm)	Color	Units per box	Comments	Reorder code
V-20 1/2 CIRCLE 26mm 	5-0	1	30	75	VIOLET	36		GL-120
	4-0	1.5	18	45	VIOLET	12	5 strands, D-Tach™	GL-64-MG
	4-0	1.5	18	45	VIOLET	12	5 strands, D-Tach™	GLJ-58-M
	4-0	1.5	30	75	UNDYED	36	Surgalloy™	GLS-321
	4-0	1.5	30	75	UNDYED	36		GL-321
	4-0	1.5	30	75	VIOLET	36		GL-121
	4-0	1.5	30	75	VIOLET	12	5 strands, D-Tach™	GL-68-M
	4-0	1.5	30	75	VIOLET	36	Surgalloy™	GLS-121
	3-0	2	18	45	VIOLET	12	5 strands, D-Tach™	GLJ-53-M
	3-0	2	18	45	UNDYED	12	5 strands, D-Tach™	GL-69-MG
	3-0	2	18	45	VIOLET	12	5 strands, D-Tach™	GL-63-MG
	3-0	2	30	75	VIOLET	12	5 strands, D-Tach™	GL-67-M
	3-0	2	30	75	UNDYED	36		GL-322
	3-0	2	30	75	VIOLET	36	Surgalloy™	GLS-122
	3-0	2	30	75	VIOLET	36		GL-122
	3-0	2	30	75	UNDYED	36	Surgalloy™	GLS-322
	3-0	2	36	90	VIOLET	36		GL-226
	2-0	3	18	45	UNDYED	12	5 strands, D-Tach™	GL-61-MG
	2-0	3	18	45	VIOLET	12	5 strands, D-Tach™	GL-62-MG
	2-0	3	30	75	VIOLET	12	5 strands, D-Tach™	GL-66-M
	2-0	3	30	75	VIOLET	36	Surgalloy™	GLS-123
	2-0	3	30	75	UNDYED	36	Surgalloy™	GLS-323
	2-0	3	30	75	VIOLET	36		GL-123
	2-0	3	30	75	UNDYED	36		GL-323
	2-0	3	36	90	VIOLET	36		GL-125
	0	3.5	30	75	UNDYED	36		GL-324
	0	3.5	30	75	VIOLET	36		GL-124
V-20 - V-20 1/2 CIRCLE 26mm (Double armed) 	3-0	2	36	90	VIOLET	36		GL-332
	2-0	3	36	90	VIOLET	36		GL-333

Surgipro™ II and Surgipro™ 7-0, 8-0; Sofsilik™ 8-0; Polysorb™, Biosyn™, Monosof™, Maxon™, Velosorb™ Fast sutures differ from USP and EP only in diameter. Please refer to IFU for more details.

© 2018 Medtronic. All rights reserved. Medtronic, Medtronic logo and Further, Together are trademarks of Medtronic.

™*Third party brands are trademarks of their respective owners.

All other brands are trademarks of a Medtronic company.

11/2018 US170542

POLYSORB™

Lactomer™ 9 - 1, Coated, Braided Synthetic Absorbable Sutures

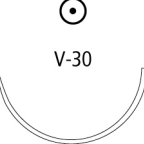
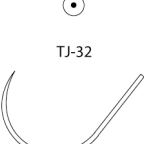
TAPER POINT								
Description	USP Size	EP Size	Length (in)	Length (cm)	Color	Units per box	Comments	Reorder code
GS-22 1/2 CIRCLE 27mm 	3-0	2	30	75	VIOLET	36		CL-882
	3-0	2	30	75	UNDYED	36		CL829
	2-0	3	18	45	VIOLET	12	5 strands, D-Tach™	CL-16-MG
	2-0	3	30	75	UNDYED	36		CL-830
	2-0	3	30	75	VIOLET	36		CL-883
	0	3.5	18	45	VIOLET	12	5 strands, D-Tach™	CL-17-MG
	0	3.5	30	75	UNDYED	36		CL-831
	0	3.5	30	75	VIOLET	12	5 strands, D-Tach™	CL-886-M
	0	3.5	30	75	VIOLET	36	Surgalloy™	CL-884
	0	3.5	36	90	VIOLET	36		CL-330
	2	5	30	75	VIOLET	36		CL-232
	1	4	30	75	UNDYED	36		CL-832
	1	4	30	75	VIOLET	12	5 strands, D-Tach™	CL-885-M
	1	4	30	75	VIOLET	36		CL-885
V-30 1/2 CIRCLE 30mm 	3-0	2	30	75	VIOLET	36		GL-222
	2-0	3	30	75	VIOLET	12	5 strands, D-Tach™	GL-223-M
	2-0	3	30	75	UNDYED	36		GL-228
	2-0	3	30	75	VIOLET	36		GL-223
	0	3.5	30	75	VIOLET	36		GL-224
	1	4	30	75	VIOLET	36		GL-225
TJ-32 1/2 CIRCLE 32mm 	1	4	30	75	VIOLET	36		CL-673
	1	4	30	75	VIOLET	12		CL-673G

Surgipro™ II and Surgipro™ 7-0, 8-0; Sofsil™ 8-0; Polysorb™, Biosyn™, Monosof™, Maxon™, Velosorb™ Fast sutures differ from USP and EP only in diameter. Please refer to IFU for more details.

© 2018 Medtronic. All rights reserved. Medtronic, Medtronic logo and Further, Together are trademarks of Medtronic.

™*Third party brands are trademarks of their respective owners.

All other brands are trademarks of a Medtronic company.

11/2018 US170542

POLYSORB™

Lactomer™ 9 - 1, Coated, Braided Synthetic Absorbable Sutures

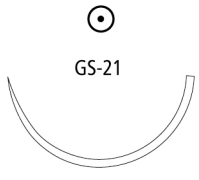
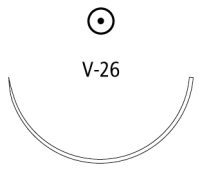
TAPER POINT								
Description	USP Size	EP Size	Length (in)	Length (cm)	Color	Units per box	Comments	Reorder code
GS-21 1/2 CIRCLE 37mm 	4-0	1.5	30	75	VIOLET	36		CL-809
	3-0	2	18	45	VIOLET	12	5 strands, D-Tach™	CL-8-MG
	3-0	2	18	45	UNDYED	12	5 strands, D-Tach™	CL-12-MG
	3-0	2	30	75	VIOLET	36		CL-810
	3-0	2	30	75	UNDYED	36		CL-842
	3-0	2	36	90	UNDYED	36		CL-952
	3-0	2	36	90	VIOLET	36		CL-922
	2-0	3	18	45	VIOLET	12	5 strands, D-Tach™	CL-9-MG
	2-0	3	18	45	UNDYED	12	5 strands, D-Tach™	CL-13-MG
	2-0	3	30	75	UNDYED	36		CL-843
	2-0	3	30	75	VIOLET	36		CL-811
	2-0	3	30	75	VIOLET	12	5 strands, D-Tach™	CL-4M
	2-0	3	36	90	VIOLET	36		CL-923
	2-0	3	36	90	UNDYED	36		CL-953
	0	3.5	18	45	VIOLET	12	5 strands, D-Tach™	CL-10-MG
	0	3.5	18	45	UNDYED	12	5 strands, D-Tach™	CL-14-MG
	0	3.5	30	75	VIOLET	24	3 strands	3-CL-812
	0	3.5	30	75	VIOLET	36	Surgalloy™	CL-812
	0	3.5	30	75	UNDYED	36		CL-844
	0	3.5	30	75	VIOLET	12	5 strands, D-Tach™	CL-5-M
	0	3.5	30	75	UNDYED	12	5 strands, D-Tach™	CL-2M
	0	3.5	36	90	VIOLET	36		CL-924
	0	3.5	36	90	UNDYED	36		CL-954
	2	5	30	75	VIOLET	36		CL-814
	2	5	36	90	VIOLET	36		CL-926
	1	4	18	45	VIOLET	12	5 strands, D-Tach™	CL-11-MG
	1	4	18	45	UNDYED	12	5 strands, D-Tach™	CL-15-MG
	1	4	30	75	UNDYED	36		CL-845
	1	4	30	75	VIOLET	36		CL-813
	1	4	30	75	VIOLET	12	5 strands, D-Tach™	CL-6-M
1	4	36	90	UNDYED	36		CL-955	
1	4	36	90	VIOLET	36		CL-925	
V-26 1/2 CIRCLE 37mm 	3-0	2	30	75	VIOLET	36		GL-126
	2-0	3	30	75	VIOLET	36		GL-127
	0	3.5	30	75	VIOLET	36		GL-128
	1	4	30	75	VIOLET	36		GL-129

Surgipro™ II and Surgipro™ 7-0, 8-0; Sofsilik™ 8-0; Polysorb™, Biosyn™, Monosof™, Maxon™, Velosorb™ Fast sutures differ from USP and EP only in diameter. Please refer to IFU for more details.

© 2018 Medtronic. All rights reserved. Medtronic, Medtronic logo and Further, Together are trademarks of Medtronic.

™*Third party brands are trademarks of their respective owners.

All other brands are trademarks of a Medtronic company.

11/2018 US170542

POLYSORB™

Lactomer™ 9 - 1, Coated, Braided Synthetic Absorbable Sutures

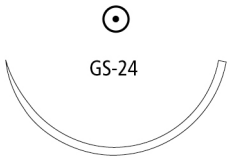
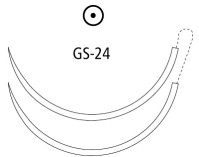
TAPER POINT								
Description	USP Size	EP Size	Length (in)	Length (cm)	Color	Units per box	Comments	Reorder code
GS-24 1/2 CIRCLE 40mm 	3-0	2	30	75	VIOLET	36		CL-800
	3-0	2	36	90	UNDYED	36		CL-962
	3-0	2	36	90	VIOLET	36		CL-912
	2-0	3	18	45	VIOLET	12	5 strands, D-Tach™	CL-22-MG
	2-0	3	30	75	UNDYED	36		CL-853
	2-0	3	30	75	VIOLET	36		CL-801
	2-0	3	36	90	UNDYED	36		CL-963
	2-0	3	36	90	VIOLET	36		CL-913
	0	3.5	18	45	VIOLET	12	5 strands, D-Tach™	CL-20-MG
	0	3.5	30	75	VIOLET	36		CL-802
	0	3.5	36	90	UNDYED	36		CL-964
	0	3.5	36	90	VIOLET	36		CL-914
	2	5	18	45	VIOLET	6	5 strands, D-Tach™	CL-623-M
	2	5	24	60	VIOLET	12	5 strands, D-Tach™	CL-622-M
	2	5	30	75	VIOLET	36		CL-779
	2	5	36	90	VIOLET	36		CL-911
	1	4	18	45	VIOLET	12	5 strands, D-Tach™	CL-21-MG
	1	4	30	75	UNDYED	36		CL-855
	1	4	30	75	VIOLET	36		CL-803
	1	4	36	90	VIOLET	36		CL-915
1	4	36	90	UNDYED	36		CL-965	
GS-24 - GS-24 1/2 CIRCLE 40mm (Double armed) (Not to scale) 	3-0	2	60	150	VIOLET	36		CL-990

Surgipro™ II and Surgipro™ 7-0, 8-0; Sofsilik™ 8-0; Polysorb™, Biosyn™, Monosof™, Maxon™, Velosorb™ Fast sutures differ from USP and EP only in diameter. Please refer to IFU for more details.

© 2018 Medtronic. All rights reserved. Medtronic, Medtronic logo and Further, Together are trademarks of Medtronic.





™*Third party brands are trademarks of their respective owners.

All other brands are trademarks of a Medtronic company.

11/2018 US170542

POLYSORB™

Lactomer™ 9 - 1, Coated, Braided Synthetic Absorbable Sutures

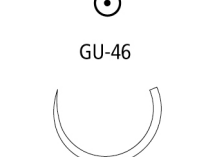
TAPER POINT								
Description	USP Size	EP Size	Length (in)	Length (cm)	Color	Units per box	Comments	Reorder code
GS-25 1/2 CIRCLE 48mm (Not to scale) 	3-0	2	30	75	VIOLET	36		CL-862
	3-0	2	36	90	UNDYED	36		CL-972
	2-0	3	18	45	UNDYED	12	5 strands, D-Tach™	CL-36-MG
	2-0	3	30	75	VIOLET	36		CL-863
	2-0	3	36	90	VIOLET	36		CL-903
	2-0	3	36	90	UNDYED	36		CL-973
	0	3.5	18	45	UNDYED	12	5 strands, D-Tach™	CL-35-MG
	0	3.5	18	45	VIOLET	12	5 strands, D-Tach™	CL-30-MG
	0	3.5	30	75	VIOLET	36		CL-864
	0	3.5	36	90	UNDYED	36		CL-974
	0	3.5	36	90	VIOLET	36		CL-904
	2	5	18	45	VIOLET	6	5 strands, D-Tach™	CL-633-M
	2	5	24	60	VIOLET	12	5 strands, D-Tach™	CL-644-M
	2	5	30	75	VIOLET	6	5 strands, D-Tach™	CL-665-M
	2	5	30	75	VIOLET	36		CL-866
	2	5	36	90	VIOLET	36		CL-906
	1	4	18	45	VIOLET	12	5 strands, D-Tach™	CL-31-MG
	1	4	30	75	VIOLET	36		CL-865
	1	4	30	75	VIOLET	12	5 strands, D-Tach™	CL-64-M
	GS-26 1/2 CIRCLE 65mm (Not to scale) 	2-0	3	30	75	UNDYED	24	
2		5	30	75	VIOLET	6	5 strands	CL-659-M
2		5	40	100	UNDYED	36		CL-969
2		5	60	150	UNDYED	24		CL-880
2		5	60	150	VIOLET	24		CL-825
1		4	30	75	VIOLET	12	5 strands	CL-60-M
1		4	36	90	VIOLET	36		CL-968
1		4	60	150	VIOLET	24		CL-824
GS-26 LOOP 1/2 CIRCLE 65mm (Not to scale) 	2	5	96	240	VIOLET	24		CL-835-L
	1	4	48	120	VIOLET	24	Loop	CL824L
GS-27 1/2 CIRCLE 76mm (Not to scale) 	2-0	3	30	75	UNDYED	24		CL-53
	0	3.5	30	75	VIOLET	36		CL-84
	1	4	30	75	VIOLET	24		SL-603
GU-46 5/8 CIRCLE 27mm 	3-0	2	30	75	VIOLET	36		UL-879
	2-0	3	30	75	VIOLET	36		UL-878
	0	3.5	30	75	VIOLET	36		UL-877
	1	4	30	75	VIOLET	36		UL-876

Surgipro™ II and Surgipro™ 7-0, 8-0; Sofsilik™ 8-0; Polysorb™, Biosyn™, Monosof™, Maxon™, Velosorb™ Fast sutures differ from USP and EP only in diameter. Please refer to IFU for more details.

© 2018 Medtronic. All rights reserved. Medtronic, Medtronic logo and Further, Together are trademarks of Medtronic.



™*Third party brands are trademarks of their respective owners.

All other brands are trademarks of a Medtronic company.

11/2018 US170542

POLYSORB™

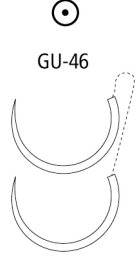
Lactomer™ 9 - 1, Coated, Braided Synthetic Absorbable Sutures

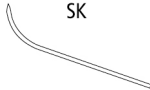
TAPER POINT									
Description	USP Size	EP Size	Length (in)	Length (cm)	Color	Units per box	Comments	Reorder code	
GU-46 - GU-46 5/8 CIRCLE 27mm (Double armed)  GU-46	0	3.5	36	90	VIOLET	36		UL-240	
GU-45 5/8 CIRCLE 37mm  GU-45	2-0	3	30	75	VIOLET	36		UL-245	
	0	3.5	30	75	VIOLET	36		UL-246	
GU-44 5/8 CIRCLE 40mm  GU-44	0	3.5	30	75	VIOLET	36		UL-146	
SK SKI 23mm  SK	4-0	1.5	48	120	VIOLET	24	Endoscopy	EL-451	
	3-0	2	7	18	VIOLET	36	Endoscopy	EL-415	
	3-0	2	48	120	VIOLET	24	Endoscopy	EL-450	

Surgipro™ II and Surgipro™ 7-0, 8-0; Sofsilik™ 8-0; Polysorb™, Biosyn™, Monosof™, Maxon™, Velosorb™ Fast sutures differ from USP and EP only in diameter. Please refer to IFU for more details.

© 2018 Medtronic. All rights reserved. Medtronic, Medtronic logo and Further, Together are trademarks of Medtronic.





™*Third party brands are trademarks of their respective owners.

All other brands are trademarks of a Medtronic company.

11/2018 US170542

POLYSORB™

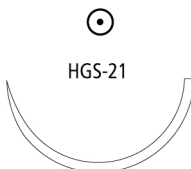
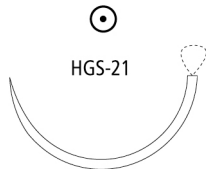
Lactomer™ 9 - 1, Coated, Braided Synthetic Absorbable Sutures

HEAVY TAPER POINT									
Description	USP Size	EP Size	Length (in)	Length (cm)	Color	Units per box	Comments	Reorder code	
HGS-22 1/2 CIRCLE 27mm 	2-0	3	18	45	VIOLET	12	5 strands, D-Tach™	CL-86-MG	
	0	3.5	18	45	UNDYED	12	5 strands, D-Tach™	CL-87-MG	
	1	4	30	75	VIOLET	36		CL-871	
HGS-20 1/2 CIRCLE 34mm 	2-0	3	30	75	VIOLET	12	5 strands, D-Tach™	CL-996-MG	
	0	3.5	30	75	VIOLET	12	5 strands, D-Tach™	CL-997-MG	
	1	4	30	75	VIOLET	12	5 strands, D-Tach™	CL-998-MG	
HGS-21 1/2 CIRCLE 37mm 	2-0	3	18	45	VIOLET	12	5 strands, D-Tach™	CL-202-M	
	2-0	3	30	75	VIOLET	36		CL-930	
	2-0	3	36	90	VIOLET	36		CL-970	
	0	3.5	18	45	VIOLET	12	5 strands, D-Tach™	CL-200-M	
	0	3.5	30	75	VIOLET	36		CL-931	
	0	3.5	30	75	VIOLET	12	5 strands, D-Tach™	CL-71-M	
	0	3.5	36	90	VIOLET	36		CL-971	
	2	5	30	75	VIOLET	36		CL-934	
	1	4	18	45	VIOLET	12	5 strands, D-Tach™	CL-201-M	
	1	4	30	75	VIOLET	36		CL-932	
	1	4	36	90	VIOLET	36		CL-239	
HGS-21 LOOP 1/2 CIRCLE 37mm 	0	3.5	60	150	VIOLET	24	Loop	CL-871-L	
HGU-46 5/8 CIRCLE 27mm 	0	3.5	18	45	VIOLET	36		CL-576	
	0	3.5	30	75	VIOLET	36		CL-677	
	1	4	30	75	VIOLET	36		UL-676	

Surgipro™ II and Surgipro™ 7-0, 8-0; Sofsilik™ 8-0; Polysorb™, Biosyn™, Monosof™, Maxon™, Velosorb™ Fast sutures differ from USP and EP only in diameter. Please refer to IFU for more details.

© 2018 Medtronic. All rights reserved. Medtronic, Medtronic logo and Further, Together are trademarks of Medtronic.

™*Third party brands are trademarks of their respective owners.

All other brands are trademarks of a Medtronic company.

11/2018 US170542

POLYSORB™

Lactomer™ 9 - 1, Coated, Braided Synthetic Absorbable Sutures

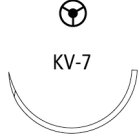
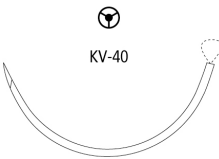
TAPERCUTTING									
Description	USP Size	EP Size	Length (in)	Length (cm)	Color	Units per box	Comments	Reorder code	
KV-7 1/2 CIRCLE 26mm 	3-0	2	30	75	VIOLET	36	Surgalloy™	CL-510	
	2-0	3	30	75	VIOLET	36	Surgalloy™	CL-511	
KV-34 1/2 CIRCLE 37mm 	3-0	2	36	90	VIOLET	36		CL-942	
	3-0	2	36	90	UNDYED	36		CL-947	
	2-0	3	30	75	VIOLET	36		CL-837	
	2-0	3	36	90	VIOLET	36		CL-943	
	2-0	3	36	90	UNDYED	36		CL-946	
	0	3.5	30	75	VIOLET	36		CL-838	
	0	3.5	36	90	UNDYED	36		CL-515	
	0	3.5	36	90	VIOLET	36		CL-944	
	2	5	36	90	VIOLET	36		CL-517	
	1	4	30	75	VIOLET	36		CL-839	
	1	4	36	90	UNDYED	36		CL-516	
KV-37 1/2 CIRCLE 40mm 	2-0	3	30	75	VIOLET	36		CL-603	
	0	3.5	30	75	VIOLET	36		CL-602	
KV-40 1/2 CIRCLE 48mm (Not to scale) 	0	3.5	36	90	VIOLET	36		CL-739	
	2	5	30	75	VIOLET	36		CL-841	
	2	5	36	90	VIOLET	36		CL-941	
	1	4	30	75	VIOLET	36		CL-840	
	1	4	36	90	VIOLET	36		CL-940	
KV-40 LOOP 1/2 CIRCLE 48mm (Not to scale) 	2	5	60	150	VIOLET	24	Loop	CL-741-L	
	1	4	60	150	VIOLET	24	Loop	CL-740-L	

Surgipro™ II and Surgipro™ 7-0, 8-0; Sofsil™ 8-0; Polysorb™, Biosyn™, Monosof™, Maxon™, Velosorb™ Fast sutures differ from USP and EP only in diameter. Please refer to IFU for more details.

© 2018 Medtronic. All rights reserved. Medtronic, Medtronic logo and Further, Together are trademarks of Medtronic.





™*Third party brands are trademarks of their respective owners.

All other brands are trademarks of a Medtronic company.

11/2018 US170542

POLYSORB™

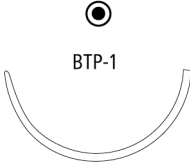
Lactomer™ 9 - 1, Coated, Braided Synthetic Absorbable Sutures

BLUNT TAPER POINT									
Description	USP Size	EP Size	Length (in)	Length (cm)	Color	Units per box	Comments	Reorder code	
BTV-20 1/2 CIRCLE 26mm 	3-0	2	18	45	UNDYED	12	5 strands, D-Tach™, ProtectPoint™	GLT-69-MG	
BGS-21 1/2 CIRCLE 37mm 	2-0	3	36	90	VIOLET	36	Protect Point™	CL-956	
	2-0	3	36	90	UNDYED	36	Protect Point™	CL-259	
	0	3.5	18	45	VIOLET	12	5 strands, D-Tach™, ProtectPoint™	CL-250-M	
	0	3.5	18	45	UNDYED	12	5 strands, D-Tach™, ProtectPoint™	CL-240-M	
	0	3.5	36	90	VIOLET	36	Protect Point™	CL-957	
	1	4	36	90	VIOLET	36	Protect Point™	CL-958	
BTP-1 1/2 CIRCLE 37mm 	3-0	2	36	90	UNDYED	36	Protect Point™	CLT-952	
	2-0	3	18	45	VIOLET	12	5 strands, D-Tach™, ProtectPoint™	CLT-9-MG	
	2-0	3	18	45	UNDYED	12	5 strands, D-Tach™, ProtectPoint™	CLT-13-MG	
	2-0	3	30	75	UNDYED	36	Protect Point™	CLT-259	
	2-0	3	36	90	UNDYED	36	Protect Point™	CLT-953	
	0	3.5	18	45	VIOLET	12	5 strands, Protect Point™, D-Tach™	CLT-250-MG	
	0	3.5	30	75	VIOLET	36	Protect Point™	CLT-957	
	0	3.5	30	75	VIOLET			CLT151MG	
	0	3.5	36	90	UNDYED	36	Protect Point™	CLT-954	
	1	4	18	45	UNDYED	12	5 strands, D-Tach™, ProtectPoint™	CLT-15-MG	
	1	4	18	45	VIOLET	12	5 strands, D-Tach™, ProtectPoint™	CLT-11-MG	
	1	4	30	75	VIOLET	36	Protect Point™	CLT-958	
	1	4	36	90	UNDYED	36	Protect Point™	CLT-955	
BGS-24 1/2 CIRCLE 40mm 	0	3.5	36	90	VIOLET	36	Protect Point™	CL-950	
	1	4	36	90	VIOLET	36	Protect Point™	CL-951	
BGS-25 1/2 CIRCLE 48mm (Not to scale) 	0	3.5	36	90	VIOLET	36	Protect Point™	CL-948	
	1	4	18	45	VIOLET	12	5 strands, D-Tach™, ProtectPoint™	CL-851-M	
	1	4	36	90	VIOLET	36	Protect Point™	CL-949	

Surgipro™ II and Surgipro™ 7-0, 8-0; Sofsilik™ 8-0; Polysorb™, Biosyn™, Monosof™, Maxon™, Velosorb™ Fast sutures differ from USP and EP only in diameter. Please refer to IFU for more details.

© 2018 Medtronic. All rights reserved. Medtronic, Medtronic logo and Further, Together are trademarks of Medtronic.



™*Third party brands are trademarks of their respective owners.

All other brands are trademarks of a Medtronic company.

11/2018 US170542

POLYSORB™

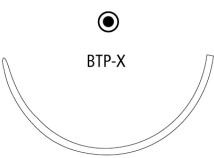
Lactomer™ 9 - 1, Coated, Braided Synthetic Absorbable Sutures

BLUNT TAPER POINT									
Description	USP Size	EP Size	Length (in)	Length (cm)	Color	Units per box	Comments	Reorder code	
BTP-X 1/2 CIRCLE 48mm (Not to scale)		0	3.5	18	45	UNDYED	12	5 strands, D-Tach™, ProtectPoint™	CLT-20-MG
		0	3.5	18	45	VIOLET	12	5 strands, D-Tach™, ProtectPoint™	CLT-850-MG
		0	3.5	18	45	UNDYED			CLT844
		2	5	18	45	VIOLET	6	5 strands, D-Tach™, ProtectPoint™	CLT-623-M
		1	4	18	45	UNDYED	12	5 strands, D-Tach™, ProtectPoint™	CLT-21-MG
		1	4	18	45	VIOLET	12	5 strands, D-Tach™, ProtectPoint™	CLT-851-MG
		1	4	36	90	UNDYED	36	Protect Point™	CLT-855
BGS-29 1/2 CIRCLE 63mm (Not to scale)		2	5	36	90	VIOLET	12	2 strands, ProtectPoint™	2-CL-852
BGST-29 1/2 CIRCLE 65mm (Not to scale)		2	5	30	75	VIOLET	6	5 strands, D-Tach™, ProtectPoint™	CLT-633-M

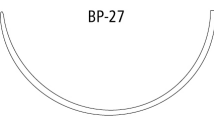
BLUNT POINT									
Description	USP Size	EP Size	Length (in)	Length (cm)	Color	Units per box	Comments	Reorder code	
BP-27 1/2 CIRCLE 64mm (Not to scale)		2	5	36	90	VIOLET	36	Protect Point™	CL-270
		1	4	36	90	VIOLET	36	Protect Point™	CL-271

Surgipro™ II and Surgipro™ 7-0, 8-0; Sofsilik™ 8-0; Polysorb™, Biosyn™, Monosof™, Maxon™, Velosorb™ Fast sutures differ from USP and EP only in diameter. Please refer to IFU for more details.

© 2018 Medtronic. All rights reserved. Medtronic, Medtronic logo and Further, Together are trademarks of Medtronic.



™*Third party brands are trademarks of their respective owners.



All other brands are trademarks of a Medtronic company.

11/2018 US170542

POLYSORB™

Lactomer™ 9 - 1, Coated, Braided Synthetic Absorbable Sutures

DIAMOND POINT									
Description	USP Size	EP Size	Length (in)	Length (cm)	Color	Units per box	Comments	Reorder code	
KV-25 1/2 CIRCLE 22mm  KV-25	1	4	30	75	UNDYED	36		CL-513	
KV-30 1/2 CIRCLE 27mm  KV-30	0	3.5	36	90	UNDYED	36		CL-730	

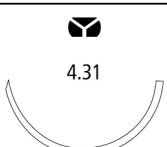
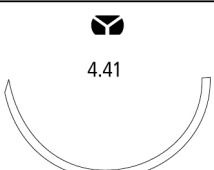
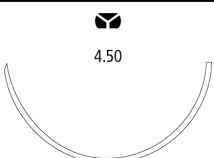
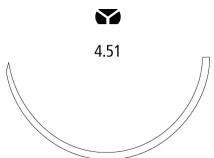
MULTIPURPOSE									
Description	USP Size	EP Size	Length (in)	Length (cm)	Color	Units per box	Comments	Reorder code	
3.16 3/8 CIRCLE 16mm  3.16	4-0	1.5	18	45	UNDYED	36		CL-005	
4.21 (H) 1/2 CIRCLE 20mm  4.21	2-0	3	30	75	VIOLET	36		CL-015	
4.31 (H) 1/2 CIRCLE 30mm  4.31	0	3.5	30	75	VIOLET	36		CL-030	
4.41 1/2 CIRCLE 40mm  4.41	2-0	3	30	75	VIOLET	36		CL-045	
	0	3.5	30	75	VIOLET	36		UL-046	
	1	4	30	75	VIOLET	36		CL-047	
4.5 1/2 CIRCLE 50mm (Not to scale)  4.50	2	5	36	90	VIOLET	36		CL-055	
4.51 (H) 1/2 CIRCLE 50mm (Not to scale)  4.51	2-0	3	30	75	VIOLET	36		CL-060	

Surgipro™ II and Surgipro™ 7-0, 8-0; Sofsilik™ 8-0; Polysorb™, Biosyn™, Monosof™, Maxon™, Velosorb™ Fast sutures differ from USP and EP only in diameter. Please refer to IFU for more details.

© 2018 Medtronic. All rights reserved. Medtronic, Medtronic logo and Further, Together are trademarks of Medtronic.







™*Third party brands are trademarks of their respective owners.



All other brands are trademarks of a Medtronic company.

11/2018 US170542

POLYSORB™

Lactomer™ 9 - 1, Coated, Braided Synthetic Absorbable Sutures

PREMIUM SPATULA									
Description	USP Size	EP Size	Length (in)	Length (cm)	Color	Units per box	Comments	Reorder code	
SE-100-8 - SE-100-8 1/4 CIRCLE 6.3mm (Double armed) 	6-0	0.7	18	45	VIOLET	12	Surgalloy™	L-1750K	
SS-14 - SS-14 1/4 CIRCLE 8.6mm (Double armed) 	6-0	0.7	18	45	VIOLET	12	Surgalloy™	L-1791K	
	6-0	0.7	18	45	UNDYED	12	Surgalloy™	L-1670-K	
	5-0	1	18	45	UNDYED	12	Surgalloy™	L-1669-K	
	5-0	1	18	45	VIOLET	12	Surgalloy™	L-1792K	
SS-24 - SS-24 1/4 CIRCLE 8.6mm (Double armed) 	6-0	0.7	8	20	VIOLET	12	Surgalloy™	L-1740-K	
	6-0	0.7	12	30	UNDYED	12	Surgalloy™	L-1745K	
	6-0	0.7	12	30	VIOLET	12	Surgalloy™	L-1742K	
	6-0	0.7	18	45	UNDYED	24	Surgalloy™	L-2752K	
	5-0	1	8	20	VIOLET	12	Surgalloy™	L-1739-K	
	5-0	1	12	30	VIOLET	12	Surgalloy™	L-1785K	
	5-0	1	18	45	UNDYED	24	Surgalloy™	L-2753K	
SE-140-8 3/8 CIRCLE 6.3mm 	8-0	0.4	12	30	VIOLET	12	Surgalloy™	L-2750K	
	7-0	0.5	12	30	VIOLET	12	Surgalloy™	L-2751K	
SE-140-8 - SE-140-8 3/8 CIRCLE 6.3mm (Double armed) 	8-0	0.4	8	20	VIOLET	12	Surgalloy™	L-2747K	
	8-0	0.4	12	30	VIOLET	12	Surgalloy™	L-2748K	
	8-0	0.4	18	45	VIOLET	12	Surgalloy™	L-5118K	
	7-0	0.5	12	30	VIOLET	12	Surgalloy™	L-1796K	
	7-0	0.5	18	45	VIOLET	12	Surgalloy™	L-1897K	
SE-160-8 - SE-160-8 1/2 CIRCLE 5.5mm (Double armed) 	8-0	0.4	8	20	VIOLET	12	Surgalloy™	L-2574K	
	8-0	0.4	12	30	VIOLET	12	Surgalloy™	L-2749K	
	7-0	0.5	18	45	VIOLET	12	Surgalloy™	L-1787K	
SS-2 - SS-2 1/2 CIRCLE 8.6mm (Double armed) 	5-0	1	12	30	UNDYED	12	Surgalloy™	L-0223K	

INVERTED PREMIUM SPATULA									
Description	USP Size	EP Size	Length (in)	Length (cm)	Color	Units per box	Comments	Reorder code	
SS-29 - SS-29 1/4 CIRCLE 7.4mm (Double armed) 	6-0	0.7	12	30	VIOLET	12	Surgalloy™	L-1756K	
	6-0	0.7	18	45	VIOLET	12	Surgalloy™	L-1755K	
SS-28 - SS-28 3/8 CIRCLE 7.4mm (Double armed) 	6-0	0.7	18	45	VIOLET	12	Surgalloy™	L-1562-K	

Surgipro™ II and Surgipro™ 7-0, 8-0; Sofsilik™ 8-0; Polysorb™, Biosyn™, Monosof™, Maxon™, Velosorb™ Fast sutures differ from USP and EP only in diameter. Please refer to IFU for more details.

© 2018 Medtronic. All rights reserved. Medtronic, Medtronic logo and Further, Together are trademarks of Medtronic.

™*Third party brands are trademarks of their respective owners.

All other brands are trademarks of a Medtronic company.

11/2018 US170542

POLYSORB™

Lactomer™ 9 - 1, Coated, Braided Synthetic Absorbable Sutures

PREMIUM CONVENTIONAL CUTTING								
Description	USP Size	EP Size	Length (in)	Length (cm)	Color	Units per box	Comments	Reorder code
PC-13 3/8 CIRCLE 11mm	6-0	0.7	18	45	UNDYED	36		SL-1660
	5-0	1	18	45	UNDYED	36		SL-1659
	4-0	1.5	18	45	UNDYED	36		SL-1658
PC-11 3/8 CIRCLE 16mm	6-0	0.7	18	45	UNDYED	12		SL-1655G
	5-0	1	18	45	UNDYED	36		SL-1656
	4-0	1.5	18	45	UNDYED	36		SL-1657
PC-12 3/8 CIRCLE 19mm	4-0	1.5	18	45	UNDYED	36		SL-1653
	3-0	2	18	45	UNDYED	36		SL-1654

Surgipro™ II and Surgipro™ 7-0, 8-0; Sofsilik™ 8-0; Polysorb™, Biosyn™, Monosof™, Maxon™, Velosorb™ Fast sutures differ from USP and EP only in diameter. Please refer to IFU for more details.

© 2018 Medtronic. All rights reserved. Medtronic, Medtronic logo and Further, Together are trademarks of Medtronic.

™*Third party brands are trademarks of their respective owners.

All other brands are trademarks of a Medtronic company.

11/2018 US170542

POLYSORB™

Lactomer™ 9 - 1, Coated, Braided Synthetic Absorbable Sutures

Reorder Code	Page	Reorder Code	Page	Reorder Code	Page
2-CL-852	42	CL-356-MG	25	CL-544	25
3-CL-812	35	CL-358-MG	25	CL-545	25
CL-005	43	CL-35-MG	37	CL-547	25
CL-015	43	CL-369-MG	25	CL-552	25
CL-030	43	CL-36-MG	37	CL-554	26
CL-045	43	CL-370-MG	25	CL-555	26
CL-047	43	CL-374-MG	25	CL-55-MG	25
CL-055	43	CL-375-MG	25	CL-568	26
CL-060	43	CL-376-MG	26	CL-569	26
CL-10-MG	35	CL-377-MG	26	CL-570	26
CL-11-MG	35	CL-380-MG	26	CL-576	39
CL-12-MG	35	CL-381-MG	26	CL-581	25
CL-13-MG	35	CL-382-MG	26	CL-595	26
CL-14-MG	35	CL-383-MG	26	CL-596	26
CL-15-MG	35	CL-42-MG	32	CL-597	26
CL-16-MG	34	CL-457	30	CL-5-M	35
CL-17-MG	34	CL-460	31	CL-602	40
CL-200-M	39	CL-461	31	CL-603	40
CL-201-M	39	CL-462	31	CL-60-M	37
CL-202-M	39	CL-4M	35	CL-622-M	36
CL-20-MG	36	CL-510	40	CL-623-M	36
CL-219	31	CL-511	40	CL-63	37
CL-21-MG	36	CL-513	43	CL-633-M	37
CL-22-MG	36	CL-515	40	CL-644-M	37
CL-232	34	CL-516	40	CL-64-M	37
CL-239	39	CL-517	40	CL-659-M	37
CL-240-M	41	CL-526	25	CL-665-M	37
CL-250-M	41	CL-528	25	CL-673	34
CL-259	41	CL-52-MG	24	CL-673G	34
CL-270	42	CL-53	37	CL-677	39
CL-271	42	CL-533	25	CL-6-M	35
CL-2M	35	CL-534	25	CL-71-M	39
CL-304	30	CL-535	25	CL-730	43
CL-30-MG	37	CL-536	25	CL-739	40
CL-31-MG	37	CL-537	25	CL-740-L	40
CL-330	34	CL-538	25	CL-741-L	40
CL-331	34	CL-53MG	24	CL-769	24
CL-354-MG	25	CL-542	25	CL-779	36
CL-355-MG	25	CL-543	25	CL-782	30

Surgipro™ II and Surgipro™ 7-0, 8-0; Sofsilik™ 8-0; Polysorb™, Biosyn™, Monosoft™, Maxon™, Velosorb™ Fast sutures differ from USP and EP only in diameter. Please refer to IFU for more details.

© 2018 Medtronic. All rights reserved. Medtronic, Medtronic logo and Further, Together are trademarks of Medtronic.

™*Third party brands are trademarks of their respective owners.

All other brands are trademarks of a Medtronic company.

11/2018 US170542

POLYSORB™

Lactomer™ 9 - 1, Coated, Braided Synthetic Absorbable Sutures

Reorder Code	Page	Reorder Code	Page	Reorder Code	Page
CL-800	36	CL-855	36	CL-923	35
CL-801	36	CL-862	37	CL-924	35
CL-802	36	CL-863	37	CL-925	35
CL-803	36	CL-864	37	CL-926	35
CL-804	26	CL-865	37	CL-927	26
CL-805	26	CL-866	37	CL-928	26
CL-809	35	CL-867	24	CL-929	26
CL-810	35	CL-868	24	CL-930	39
CL-811	35	CL-869	24	CL-931	39
CL-812	35	CL-86-MG	39	CL-932	39
CL-813	35	CL-870	24	CL-933	26
CL-814	35	CL-871	39	CL-934	39
CL-815	25	CL-871-L	39	CL-936	26
CL-816	25	CL-87-MG	39	CL-937	26
CL-817	25	CL-880	37	CL-939	26
CL-818	25	CL-882	34	CL-940	40
CL-823	23	CL-883	34	CL-941	40
CL-824	37	CL-884	34	CL-942	40
CL824L	37	CL-885	34	CL-943	40
CL-825	37	CL-885-M	34	CL-944	40
CL829	34	CL-886-M	34	CL-945	40
CL-830	34	CL-892	32	CL-946	40
CL-831	34	CL-893	32	CL-947	40
CL-832	34	CL-894	32	CL-948	41
CL-833	26	CL-8-MG	35	CL-949	41
CL-835-L	37	CL-903	37	CL-950	41
CL-837	40	CL-904	37	CL-951	41
CL-838	40	CL-905	37	CL-952	35
CL-839	40	CL-906	37	CL-953	35
CL-84	37	CL-911	36	CL-954	35
CL-840	40	CL-912	36	CL-955	35
CL-841	40	CL-913	36	CL-956	41
CL-842	35	CL-914	36	CL-957	41
CL-843	35	CL-915	36	CL-958	41
CL-844	35	CL-916	25	CL-962	36
CL-845	35	CL-917	25	CL-963	36
CL-85	24	CL-918	25	CL-964	36
CL-851-M	41	CL-919	25	CL-965	36
CL-853	36	CL-922	35	CL-968	37

Surgipro™ II and Surgipro™ 7-0, 8-0; Sofsilik™ 8-0; Polysorb™, Biosyn™, Monosoft™, Maxon™, Velosorb™ Fast sutures differ from USP and EP only in diameter. Please refer to IFU for more details.

© 2018 Medtronic. All rights reserved. Medtronic, Medtronic logo and Further, Together are trademarks of Medtronic.

™*Third party brands are trademarks of their respective owners.

All other brands are trademarks of a Medtronic company.

11/2018 US170542

POLYSORB™

Lactomer™ 9 - 1, Coated, Braided Synthetic Absorbable Sutures

Reorder Code	Page	Reorder Code	Page	Reorder Code	Page
CL-969	37	EL-415	38	GL-44-MG	30
CL-970	39	EL-440	32	GL-45-MG	30
CL-971	39	EL-450	38	GL-46-MG	31
CL-972	37	EL-451	38	GL-47-MG	31
CL-973	37	GL-120	33	GL-522	30
CL-974	37	GL-121	33	GL-523	30
CL-975	37	GL-122	33	GL-524	30
CL-976	24	GL-123	33	GL-61-MG	33
CL-977	24	GL-124	33	GL-62-MG	33
CL-979	26	GL-125	33	GL-63-MG	33
CL-97-MG	26	GL-126	35	GL-64-MG	33
CL-982	25	GL-127	35	GL-66-M	33
CL-990	36	GL-128	35	GL-67-M	33
CL-992	25	GL-129	35	GL-68-M	33
CL-996-MG	39	GL-181	32	GL-69-MG	33
CL-997-MG	39	GL-182	32	GL72MG	32
CL-998-MG	39	GL-182-M	32	GL79MG	32
CL-9-MG	35	GL-183	32	GL-881	30
CLT-11-MG	41	GL-191	32	GL-882	30
CLT-13-MG	41	GL-192	32	GL-884	30
CLT151MG	41	GL-222	34	GL-885	30
CLT-15-MG	41	GL-223	34	GL889-2	30
CLT-20-MG	42	GL-223-M	34	GL-889-2	30
CLT-21-MG	42	GL-224	34	GL-890	30
CLT-250-MG	41	GL-225	34	GLJ-50-M	32
CLT-259	41	GL-226	33	GLJ-51-M	32
CLT-623-M	42	GL-228	34	GLJ-53-M	33
CLT-633-M	42	GL-282	32	GLJ-54-M	30
CLT844	42	GL-302	30	GLJ-56-M	31
CLT-850-MG	42	GL-303	30	GLJ-57-M	31
CLT-851-MG	42	GL-321	33	GLJ-58-M	33
CLT-855	42	GL-322	33	GLS-121	33
CLT-952	41	GL-323	33	GLS-122	33
CLT-953	41	GL-324	33	GLS-123	33
CLT-954	41	GL-32-MG	32	GLS-321	33
CLT-955	41	GL-332	33	GLS-322	33
CLT-957	41	GL-333	33	GLS-323	33
CLT-958	41	GL-33-MG	32	GLT-69-MG	41
CLT-9-MG	41	GL-34-MG	32	L-0223K	44

Surgipro™ II and Surgipro™ 7-0, 8-0; Sofsilik™ 8-0; Polysorb™, Biosyn™, Monosof™, Maxon™, Velosorb™ Fast sutures differ from USP and EP only in diameter.

Please refer to IFU for more details.

© 2018 Medtronic. All rights reserved. Medtronic, Medtronic logo and Further, Together are trademarks of Medtronic.

™*Third party brands are trademarks of their respective owners.

All other brands are trademarks of a Medtronic company.

11/2018 US170542

POLYSORB™

Lactomer™ 9 - 1, Coated, Braided Synthetic Absorbable Sutures

Reorder Code	Page	Reorder Code	Page	Reorder Code	Page
L-1-	21	L-26	21	LL-102	22
L-102	22	L-27	21	LL-103	22
L-103	22	L-2747K	44	LL-104	22
L-104	22	L-2748K	44	LL-111	22
L-11	21	L-2749K	44	LL-112	22
L-111	22	L-2750K	44	LL113	22
L-112	22	L-2751K	44	LL-114	22
L113	22	L-2752K	44	LL-115	22
L-114	22	L-2753K	44	LL-116	22
L-115	22	L-28	21	LL-221	22
L-116	22	L-2800	30	LL-222	22
L-12	21	L-3	21	LL-223	22
L-13-	21	L-32	21	LL-224	22
L-14	21	L-33	21	LL-225	22
L-15	21	L-34	21	LL-226	22
L-1551-K	23	L-35	21	LL-233	22
L-1562-K	44	L-36	21	LL-322	22
L-1669-K	44	L-38	21	LL-323	22
L-1670-K	44	L-39	21	SL-1510G	28
L-1739-K	44	L-4	21	SL-1596	28
L-1740-K	44	L-40	21	SL-1613	28
L-1742K	44	L-402	21	SL-1614	28
L-1745K	44	L-403	21	SL-1614G	28
L-1750K	44	L-404	21	SL-1615	28
L-1755K	44	L-405	21	SL-1624G	27
L-1756K	44	L-406	21	SL-1625	27
L-1785K	44	L-41	21	SL1625G	27
L-1787K	44	L-42	21	SL1644G	28
L-1791K	44	L-43	21	SL-1645G	28
L-1792K	44	L-4323K	23	SL-1653	45
L-1796K	44	L-5	21	SL-1654	45
L-1897K	44	L-5118K	44	SL-1655G	45
L-2-	21	L-71	21	SL-1656	45
L-20	21	L-72	21	SL-1657	45
L-22	21	L-73	21	SL-1658	45
L-23	21	L-74	21	SL-1659	45
L-24	21	L-75	21	SL-1660	45
L-25	21	L-76	21	SL-1689	27
L-2574K	44	LL-101	22	SL-1689G	27

Surgipro™ II and Surgipro™ 7-0, 8-0; Sofsilik™ 8-0; Polysorb™, Biosyn™, Monosof™, Maxon™, Velosorb™ Fast sutures differ from USP and EP only in diameter. Please refer to IFU for more details.

© 2018 Medtronic. All rights reserved. Medtronic, Medtronic logo and Further, Together are trademarks of Medtronic.

™*Third party brands are trademarks of their respective owners.

All other brands are trademarks of a Medtronic company.

11/2018 US170542

POLYSORB™

Lactomer™ 9 - 1, Coated, Braided Synthetic Absorbable Sutures

Reorder Code	Page	Reorder Code	Page	Reorder Code	Page
SL-171	23	SL-605	23	SL-822G	23
SL-172	23	SL-607	23	SL-823	23
SL-431	30	SL-608	23	SL-83-MG	24
SL-432	30	SL-611	24	SL-85-MG	24
SL-5620	27	SL-612	24	UL-046	43
SL-5621	27	SL-613	24	UL-101	30
SL-5626	27	SL-622	25	UL-102	30
SL-5627	27	SL-630	23	UL-146	38
SL-5627-G	27	SL-631	24	UL-201-2	31
SL-5628	27	SL-632	24	UL-202	31
SL-5628G	27	SL-634	23	UL-203	31
SL-5629	27	SL-635	23	UL-204	31
SL-5632	28	SL-635G	23	UL-205	31
SL-5632G	28	SL-636	23	UL-212	31
SL-5633	28	SL-637	23	UL-213	31
SL-5633G	28	SL-638	23	UL-214	31
SL-5636	27	SL-639	23	UL-215	31
SL-5636-G	27	SL-642	29	UL-216	31
SL-5637	27	SL-643	29	UL-240	38
SL-5638	27	SL-644	29	UL-245	38
SL-5640	28	SL-652	29	UL-246	38
SL-5640G	28	SL-653	29	UL-303	31
SL-5641	28	SL-654	29	UL-46-MG	31
SL-5641G	28	SL-674	24	UL-47-MG	31
SL-5678	28	SL-675	24	UL-676	39
SL-5679	28	SL-690	23	UL-876	37
SL-5679G	28	SL-691	23	UL-877	37
SL-5680	28	SL-691G	23	UL-878	37
SL-5686	27	SL-692	23	UL-879	37
SL-5686G	27	SL-693	23	ULJ-56-M	31
SL-5687	27	SL-694	23		
SL-5687G	27	SL-695	23		
SL-5688	27	SL-696	24		
SL-5688-G	27	SL-712	24		
SL-5690	27	SL-714	24		
SL-5691G	27	SL-721	25		
SL-586	24	SL-722	25		
SL-587	24	SL-73-MG	24		
SL-603	37	SL-822	23		

Surgipro™ II and Surgipro™ 7-0, 8-0; Sofsilik™ 8-0; Polysorb™, Biosyn™, Monosof™, Maxon™, Velosorb™ Fast sutures differ from USP and EP only in diameter. Please refer to IFU for more details.

© 2018 Medtronic. All rights reserved. Medtronic, Medtronic logo and Further, Together are trademarks of Medtronic.

™*Third party brands are trademarks of their respective owners.

All other brands are trademarks of a Medtronic company.

11/2018 US170542

CAPROSYN™

Polyglytone™ 6211 Monofilament Synthetic Absorbable Sutures

Description	Caprosyn™ monofilament synthetic absorbable sutures are prepared from Polyglytone™ 6211 synthetic polyester which is composed of glycolide, caprolactone, trimethylene carbonate, and lactide.
Indications	Caprosyn™ synthetic absorbable sutures are indicated for use in general soft tissue approximation and/or ligation, but not for use in cardiovascular or neurological surgery, microsurgery, or ophthalmic surgery.
Actions	Caprosyn™ synthetic absorbable sutures elicit a minimal acute inflammatory reaction in tissues, which is followed by gradual encapsulation of the suture by fibrous connective tissue. Progressive loss of tensile strength and eventual absorption of Caprosyn™ synthetic absorbable sutures occurs by means of hydrolysis.
Tensile Strength	Caprosyn™ suture retains a minimum of 50 to 60% USP and EP knot strength at 5 days post implantation, and a minimum of 20 - 30% of USP and EP knot strength at 10 days post implantation. All of the original tensile strength is essentially lost by 21 days post implantation.
Sterilization	Ethylene oxide.
Absorption	Absorption begins as a loss of tensile strength followed by a loss of mass. Absorption of Caprosyn™ synthetic absorbable suture is essentially complete by 56 days.
Packaging	Caprosyn™ synthetic absorbable sutures are available undyed (natural) or dyed with D&C Violet No. 2 in USP sizes 1 (4 metric) through 6-0 (0.7 Metric). The sutures are supplied sterile, in pre-cut lengths or ligating reels, non-needled or affixed to various needle types. The sutures are available in box quantities of one, two and three dozen. Please refer to the individual package IFUs for complete instructions, indications, contraindications, warnings and precautions.

CAPROSYN™

Polyglytone™ 6211 Monofilament Synthetic Absorbable Sutures

NON NEEDED - STANDARD LENGTH									
Description	USP Size	EP Size	Length (in)	Length (cm)	Color	Units per box	Comments	Reorder code	
STANDARD LENGTH	3-0	2	60	150	UNDYED	24	Standard Length	C-212	
	0	3.5	60	150	UNDYED	36	Standard Length	C-214	

NON NEEDED - REEL									
Description	USP Size	EP Size	Length (in)	Length (cm)	Color	Units per box	Comments	Reorder code	
REEL	2-0	3	60	150	UNDYED	24		LC-113	





Surgipro™ II and Surgipro™ 7-0, 8-0; Sofsilik™ 8-0; Polysorb™, Biosyn™, Monosof™, Maxon™, Velosorb™ Fast sutures differ from USP and EP only in diameter. Please refer to IFU for more details.

© 2018 Medtronic. All rights reserved. Medtronic, Medtronic logo and Further, Together are trademarks of Medtronic.

™*Third party brands are trademarks of their respective owners.

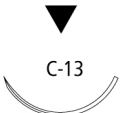
All other brands are trademarks of a Medtronic company.

11/2018 US170542

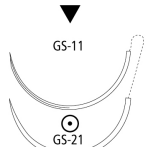
REVERSE CUTTING								
Description	USP Size	EP Size	Length (in)	Length (cm)	Color	Units per box	Comments	Reorder code
C-13 3/8 CIRCLE 19mm 	5-0	1	18	45	UNDYED	12		SC3634G
	5-0	1	18	45	UNDYED	36	Reliapoint™needle	SC-3634
	4-0	1.5	18	45	UNDYED	12	Reliapoint™needle	SC-690G
	4-0	1.5	30	75	UNDYED	36	Reliapoint™needle	SC-691
	3-0	2	18	45	UNDYED	12	Reliapoint™needle	SC-694G
	3-0	2	30	75	UNDYED	36	Reliapoint™needle	SC-692
	2-0	3	30	75	UNDYED	36	Reliapoint™needle	SC-693
C-14 3/8 CIRCLE 24mm 	3-0	2	30	75	UNDYED	12	Reliapoint™needle	SC-693G
C-15 3/8 CIRCLE 26mm 	3-0	2	30	75	UNDYED	36	Reliapoint™needle	SC-587
	2-0	3	30		UNDYED	12	Reliapoint™needle	SC586G
	2-0	3	30	75	UNDYED	36	Reliapoint™needle	SC-586
C-16 3/8 CIRCLE 30mm 	0	3.5	30	75	UNDYED	36	Reliapoint™needle	SC-585
GS-11 1/2 CIRCLE 37mm 	2-0	3	30	75	UNDYED	36		CC-543
GS-11 - GS-21 1/2 CIRCLE 37mm (Double armed) (Not to scale) 	2-0	3	60	150	UNDYED	36		CC-983







Surgipro™ II and Surgipro™ 7-0, 8-0; Sofsilik™ 8-0; Polysorb™, Biosyn™, Monosof™, Maxon™, Velosorb™ Fast sutures differ from USP and EP only in diameter. Please refer to IFU for more details.

© 2018 Medtronic. All rights reserved. Medtronic, Medtronic logo and Further, Together are trademarks of Medtronic.

™*Third party brands are trademarks of their respective owners.

All other brands are trademarks of a Medtronic company.

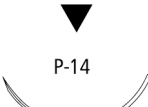
11/2018 US170542

PREMIUM REVERSE CUTTING									
Description	USP Size	EP Size	Length (in)	Length (cm)	Color	Units per box	Comments	Reorder code	
P-10 3/8 CIRCLE 11mm 	6-0	0.7	18	45	UNDYED	12	Edgellant™ needle, Surgalloy™ alloy	SC-3625G	
	5-0	1	18	45	UNDYED	12	Edgellant™ needle, Surgalloy™ alloy	SC-3626G	
P-13 3/8 CIRCLE 13mm 	6-0	0.7	18	45	UNDYED	12	Edgellant™ needle, Surgalloy™ alloy	SC-5688G	
	6-0	0.7	18	45	VIOLET	12	Edgellant™ needle, Surgalloy™ alloy	SC-5588G	
	5-0	1	18		UNDYED	12	Edgellant™ needle, Surgalloy™ alloy	SC5689G	
	5-0	1	18	45	VIOLET	12	Edgellant™ needle, Surgalloy™ alloy	SC-5587G	
	4-0	1.5	18		UNDYED	12	Edgellant™ needle, Surgalloy™ alloy	SC5690G	
	4-0	1.5	18	45	VIOLET	12	Edgellant™ needle, Surgalloy™ alloy	SC-5590G	
P-11 3/8 CIRCLE 16mm 	6-0	0.7	18	45	UNDYED	12	Edgellant™ needle, Surgalloy™ alloy	SC-5635G	
	5-0	1	18	45	UNDYED	36	Edgellant™ needle, Surgalloy™ alloy	SC-5626	
	5-0	1	18	45	UNDYED	12	Edgellant™ needle, Surgalloy™ alloy	SC-5626G	
	4-0	1.5	18	45	UNDYED	12	Edgellant™ needle, Surgalloy™ alloy	SC-5686G	
P-12 3/8 CIRCLE 19mm 	5-0	1	18	45	UNDYED	12	Edgellant™ needle, Surgalloy™ alloy	SC-5616G	
	4-0	1.5	18	45	UNDYED	12	Edgellant™ needle, Surgalloy™ alloy	SC-5617G	
	4-0	1.5	18	45	VIOLET	12	Edgellant™ needle, Surgalloy™ alloy	SC-5627G	
	4-0	1.5	30	75	UNDYED	12	Surgalloy™	SC-5637-G	
	3-0	2	18	45	UNDYED	12	Surgalloy™	SC-5618-G	
	3-0	2	30	75	UNDYED	12	Surgalloy™	SC-5638-G	
P-14 3/8 CIRCLE 24mm 	4-0	1.5	18	45	UNDYED	36	Edgellant™ needle, Surgalloy™ alloy	SC-5679	
	4-0	1.5	30	75	UNDYED	36	Edgellant™ needle, Surgalloy™ alloy	SC-5779	
	3-0	2	18	45	UNDYED	36	Edgellant™ needle, Surgalloy™ alloy	SC-5640	
	3-0	2	30	75	UNDYED	12	Edgellant™ needle, Surgalloy™ alloy	SC-5780G	
P-24 1/2 CIRCLE 16mm 	5-0	1	18	45	UNDYED	12	Surgalloy™	SC-5642G	
	4-0	1.5	18	45	UNDYED	12	Edgellant™ needle, Surgalloy™ alloy	SC-5643G	

Surgipro™ II and Surgipro™ 7-0, 8-0; Sofsilik™ 8-0; Polysorb™, Biosyn™, Monosof™, Maxon™, Velosorb™ Fast sutures differ from USP and EP only in diameter. Please refer to IFU for more details.

© 2018 Medtronic. All rights reserved. Medtronic, Medtronic logo and Further, Together are trademarks of Medtronic.



™*Third party brands are trademarks of their respective owners.

All other brands are trademarks of a Medtronic company.

CAPROSYN™

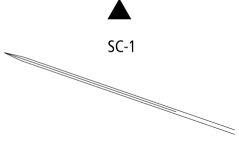
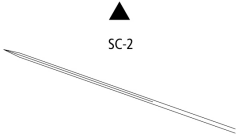
Polyglytone™ 6211 Monofilament Synthetic Absorbable Sutures

CONVENTIONAL CUTTING									
Description	USP Size	EP Size	Length (in)	Length (cm)	Color	Units per box	Comments	Reorder code	
SC-1 STRAIGHT 51mm (Not to scale)		3-0	2	30	75	UNDYED	36	Surgalloy™	SC-543
		2-0	3	30	75	UNDYED	36	Surgalloy™	SC-542
SC-2 STRAIGHT 60mm (Not to scale)		4-0	1.5	30	75	UNDYED	36	Surgalloy™	SC-644
		3-0	2	30	75	UNDYED	36		SC-643

DERMAX PREMIUM X CUTTING									
Description	USP Size	EP Size	Length (in)	Length (cm)	Color	Units per box	Comments	Reorder code	
DX-13 3/8 CIRCLE 13mm		5-0	1	18	45	UNDYED	12	DermaX	XC-834
DX-16 3/8 CIRCLE 16mm		5-0	1	18	45	UNDYED	12	DermaX	XC-844
		4-0	1.5	18	45	UNDYED	12	DermaX	XC-845
DX-19 3/8 CIRCLE 19mm		4-0	1.5	18	45	UNDYED	12	DermaX	XC-823

Surgipro™ II and Surgipro™ 7-0, 8-0; Sofsilik™ 8-0; Polysorb™, Biosyn™, Monosof™, Maxon™, Velosorb™ Fast sutures differ from USP and EP only in diameter. Please refer to IFU for more details.

© 2018 Medtronic. All rights reserved. Medtronic, Medtronic logo and Further, Together are trademarks of Medtronic.











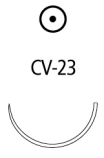

™*Third party brands are trademarks of their respective owners.

All other brands are trademarks of a Medtronic company.

11/2018 US170542

CAPROSYN™

Polyglytone™ 6211 Monofilament Synthetic Absorbable Sutures

TAPER POINT									
Description		USP Size	EP Size	Length (in)	Length (cm)	Color	Units per box	Comments	Reorder code
CV-23 1/2 CIRCLE 17mm 		6-0	0.7	30	75	UNDYED	36	Surgalloy™	UC-201
		5-0	1	30	75	UNDYED	36	Surgalloy™	UC-202
		4-0	1.5	30	75	VIOLET	36	Surgalloy™	UC-214
		4-0	1.5	30	75	UNDYED	36	Surgalloy™	UC-203
		4-0	1.5	30	75	UNDYED	12		UC203G
		3-0	2	30	75	VIOLET	12		UC213G
		3-0	2	30	75	UNDYED	36	Surgalloy™	UC-204
		3-0	2	30	75	VIOLET	36		UC-213
CV-25 1/2 CIRCLE 22mm 		4-0	1.5	30	75	UNDYED	36	Surgalloy™	UC-403
		3-0	2	18	45	UNDYED	12	5 strands, D-Tach™	GC-33-M
		3-0	2	30	75	UNDYED	36	Surgalloy™	UC-404
GS-23 1/2 CIRCLE 22mm 		2-0	3	30	75	UNDYED	36		UC-863
V-20 1/2 CIRCLE 26mm 		4-0	1.5	30	75	VIOLET	36	Surgalloy™	GC-321
		4-0	1.5	30	75	UNDYED	36	Surgalloy™	GC-121
		3-0	2	30	75	VIOLET	36	Surgalloy™	GC-322
		3-0	2	30	75	UNDYED	36	Surgalloy™	GC-122
		2-0	3	30	75	UNDYED	36	Surgalloy™	GC-123
		2-0	3	30	75	UNDYED	12		GC123G
		2-0	3	30	75	VIOLET	36	Surgalloy™	GC-323
		0	3.5	30	75	UNDYED	36	Surgalloy™	GC-124
GS-22 1/2 CIRCLE 27mm 		2-0	3	30	75	UNDYED	36		CC-883
		2-0	3	30	75	VIOLET	36		CC-830
		0	3.5	30	75	VIOLET	36		CC-831
		0	3.5	30	75	UNDYED	36		CC-884
		1	4	30	75	UNDYED	36		CC-885
GS-21 1/2 CIRCLE 37mm 		3-0	2	30	75	UNDYED	36		CC-810
		3-0	2	36	90	UNDYED	36		CC-922
		2-0	3	30	75	VIOLET	36		CC-843
		2-0	3	30	75	UNDYED	36		CC-811
		2-0	3	30	75	UNDYED	12		CC811G
		2-0	3	36	90	UNDYED	36		CC-923
		0	3.5	30	75	VIOLET	36		CC-844
		0	3.5	30	75	UNDYED	36		CC-812
		0	3.5	36	90	UNDYED	36		CC-924
		1	4	30	75	VIOLET	36		CC-845
		1	4	30	75	UNDYED	36		CC-813
		1	4	30	75	UNDYED	12		CC813G
		1	4	36	90	UNDYED	36		CC-925



Surgipro™ II and Surgipro™ 7-0, 8-0; Sofsilik™ 8-0; Polysorb™, Biosyn™, Monosof™, Maxon™, Velosorb™ Fast sutures differ from USP and EP only in diameter. Please refer to IFU for more details.

© 2018 Medtronic. All rights reserved. Medtronic, Medtronic logo and Further, Together are trademarks of Medtronic.

™*Third party brands are trademarks of their respective owners.

All other brands are trademarks of a Medtronic company.

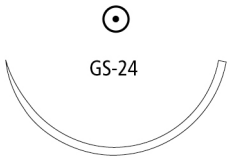
11/2018 US170542

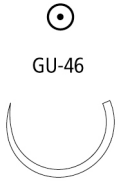
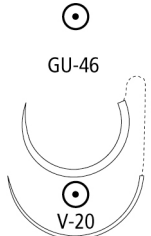
TAPER POINT									
Description	USP Size	EP Size	Length (in)	Length (cm)	Color	Units per box	Comments	Reorder code	
GS-24 1/2 CIRCLE 40mm 	3-0	2	36	90	UNDYED	36		CC-912	
	2-0	3	30	75	UNDYED	36		CC-801	
	2-0	3	36	90	UNDYED	36		CC-915	
	0	3.5	30	75	UNDYED	36		CC-802	
	0	3.5	36	90	UNDYED	36		CC-913	
	0	3.5	36	90	UNDYED	12		CC913G	
	1	4	30	75	UNDYED	36		CC-803	
	1	4	36	90	UNDYED	36		CC-914	
GS-25 1/2 CIRCLE 48mm (Not to scale) 	2-0	3	30	75	UNDYED	36		CC-872	
	0	3.5	36	90	UNDYED	36		CC-904	
	1	4	36	90	VIOLET	36		CC-975	
	1	4	36	90	UNDYED	36		CC-905	
	1	4	36	90	UNDYED	12		CC905G	
GU-46 5/8 CIRCLE 27mm 	3-0	2	30	75	VIOLET	36		UC-879	
	2-0	3	30	75	UNDYED	36		UC-978	
GU-46 - V-20 5/8 CIRCLE 27mm (Double armed) 	2-0	3	30	75	VIOLET	36	Surgalloy™	CC-658	

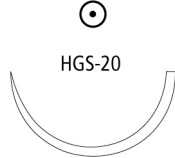
HEAVY TAPER POINT									
Description	USP Size	EP Size	Length (in)	Length (cm)	Color	Units per box	Comments	Reorder code	
HGS-20 1/2 CIRCLE 34mm 	0	3.5	18	45	UNDYED	12		CC100M	

Surgipro™ II and Surgipro™ 7-0, 8-0; Sofsilik™ 8-0; Polysorb™, Biosyn™, Monosof™, Maxon™, Velosorb™ Fast sutures differ from USP and EP only in diameter. Please refer to IFU for more details.

© 2018 Medtronic. All rights reserved. Medtronic, Medtronic logo and Further, Together are trademarks of Medtronic.

™*Third party brands are trademarks of their respective owners.

All other brands are trademarks of a Medtronic company.

11/2018 US170542

CAPROSYN™

Polyglytone™ 6211 Monofilament Synthetic Absorbable Sutures

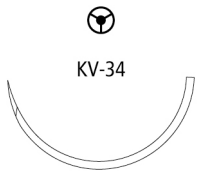
TAPERCUTTING									
Description	USP Size	EP Size	Length (in)	Length (cm)	Color	Units per box	Comments	Reorder code	
KV-34 1/2 CIRCLE 37mm 	2-0	3	36	90	UNDYED	12		CC-1945G	
	1	4	36	90	UNDYED	36	Surgalloy™	CC-196	

Surgipro™ II and Surgipro™ 7-0, 8-0; Sofsilik™ 8-0; Polysorb™, Biosyn™, Monosof™, Maxon™, Velosorb™ Fast sutures differ from USP and EP only in diameter. Please refer to IFU for more details.

© 2018 Medtronic. All rights reserved. Medtronic, Medtronic logo and Further, Together are trademarks of Medtronic.

™*Third party brands are trademarks of their respective owners.

All other brands are trademarks of a Medtronic company.

11/2018 US170542

CAPROSYN™

Polyglytone™ 6211 Monofilament Synthetic Absorbable Sutures

Reorder Code	Page	Reorder Code	Page	Reorder Code	Page
C-212	53	GC-121	57	SC-586	54
C-214	53	GC-122	57	SC586G	54
CC100M	58	GC-123	57	SC-587	54
CC-1945G	59	GC123G	57	SC-643	56
CC-196	59	GC-124	57	SC-644	56
CC-543	54	GC-321	57	SC-690G	54
CC-658	58	GC-322	57	SC-691	54
CC-801	58	GC-323	57	SC-692	54
CC-802	58	GC-33-M	57	SC-693	54
CC-803	58	LC-113	53	SC-693G	54
CC-810	57	SC-3625G	55	SC-694G	54
CC-811	57	SC-3626G	55	UC-201	57
CC811G	57	SC-3634	54	UC-202	57
CC-812	57	SC3634G	54	UC-203	57
CC-813	57	SC-542	56	UC203G	57
CC813G	57	SC-543	56	UC-204	57
CC-830	57	SC-5587G	55	UC-213	57
CC-831	57	SC-5588G	55	UC213G	57
CC-843	57	SC-5590G	55	UC-214	57
CC-844	57	SC-5616G	55	UC-403	57
CC-845	57	SC-5617G	55	UC-404	57
CC-872	58	SC-5618-G	55	UC-863	57
CC-883	57	SC-5626	55	UC-879	58
CC-884	57	SC-5626G	55	UC-978	58
CC-885	57	SC-5627G	55	XC-823	56
CC-904	58	SC-5635G	55	XC-834	56
CC-905	58	SC-5637-G	55	XC-844	56
CC905G	58	SC-5638-G	55	XC-845	56
CC-912	58	SC-5640	55		
CC-913	58	SC-5642G	55		
CC913G	58	SC-5643G	55		
CC-914	58	SC-5679	55		
CC-915	58	SC-5686G	55		
CC-922	57	SC-5688G	55		
CC-923	57	SC5689G	55		
CC-924	57	SC5690G	55		
CC-925	57	SC-5779	55		
CC-975	58	SC-5780G	55		
CC-983	54	SC-585	54		

Surgipro™ II and Surgipro™ 7-0, 8-0; Sofsilik™ 8-0; Polysorb™, Biosyn™, Monosof™, Maxon™, Velosorb™ Fast sutures differ from USP and EP only in diameter. Please refer to IFU for more details.

© 2018 Medtronic. All rights reserved. Medtronic, Medtronic logo and Further, Together are trademarks of Medtronic.

™*Third party brands are trademarks of their respective owners.

All other brands are trademarks of a Medtronic company.

11/2018 US170542

BIOSYN™

Glycomer™ 631 Monofilament Synthetic Absorbable Sutures

Description	Biosyn™ monofilament synthetic absorbable sutures are prepared from a synthetic polyester composed of glycolide, dioxanone, and trimethylene carbonate. Biosyn™ synthetic absorbable sutures are colored violet to increase visibility and are also available undyed.
Indications	Biosyn™ synthetic absorbable sutures are indicated for use in general soft tissue approximation and/or ligation, but not for use in cardiovascular or neurological surgery.
Actions	Biosyn™ synthetic absorbable sutures elicit a minimal acute inflammatory reaction in tissues, which is followed by gradual encapsulation of the suture by fibrous connective tissue. Progressive loss of tensile strength and eventual absorption of Biosyn™ synthetic absorbable sutures occurs by means of hydrolysis where the suture is broken down to glycolic acid, dioxanoic acid, propane diol and carbon dioxide which are subsequently absorbed and metabolized by the body.
Tensile Strength	Tensile strength averages for Biosyn™ synthetic absorbable sutures are approximately 75% of U.S.P and E.P. minimum knot strength at two weeks and approximately 40% at three weeks post-implant.
Sterilization	Ethylene oxide.
Absorption	Absorption begins as a loss of tensile strength without appreciable loss of mass. Absorption of Biosyn™ synthetic absorbable sutures is essentially complete between 90 and 110 days.
Packaging	Biosyn™ synthetic absorbable sutures are available undyed (natural) or dyed violet in U.S.P. and E.P. sizes 1 (4 Metric) through 6-0 (0.7 Metric). The sutures are supplied sterile, in pre-cut lengths or affixed to various needle types using both permanent and removal needle attachment techniques. Please refer to the individual package IFUs for complete instructions, indications, contraindications, warnings and precautions.

Glycomer™ 631 Monofilament Synthetic Absorbable Sutures

NON NEEDED - PRE-CUT								
Description	USP Size	EP Size	Length (in)	Length (cm)	Color	Units per box	Comments	Reorder code
PRE-CUT	4-0	1.5	18	45	VIOLET	24	6 strands	M-31-
	3-0	2	18	45	VIOLET	24	6 strands	M-32-
	3-0	2	18	45	VIOLET	36	3 strands	M-72
	2-0	3	18	45	UNDYED	24	6 strands	M-23-
	2-0	3	18	45	VIOLET	24	6 strands	M-33-
	0	3.5	18	45	VIOLET	36	3 strands	M-74
	1	4	18	45	VIOLET	36	3 strands	M-75

NON NEEDED - STANDARD LENGTH								
Description	USP Size	EP Size	Length (in)	Length (cm)	Color	Units per box	Comments	Reorder code
STANDARD LENGTH	0	3.5	60	150	VIOLET	36	Standard Length	M-114







Surgipro™ II and Surgipro™ 7-0, 8-0; Sofsilik™ 8-0; Polysorb™, Biosyn™, Monosof™, Maxon™, Velosorb™ Fast sutures differ from USP and EP only in diameter. Please refer to IFU for more details.

© 2018 Medtronic. All rights reserved. Medtronic, Medtronic logo and Further, Together are trademarks of Medtronic.

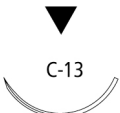
™*Third party brands are trademarks of their respective owners.

All other brands are trademarks of a Medtronic company.

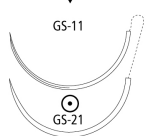
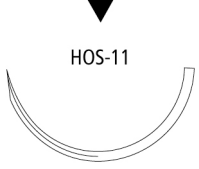
Glycomer™ 631 Monofilament Synthetic Absorbable Sutures

REVERSE CUTTING									
Description	USP Size	EP Size	Length (in)	Length (cm)	Color	Units per box	Comments	Reorder code	
C-13 3/8 CIRCLE 19mm 	5-0	1	30	75	UNDYED	36	Reliapoint™needle	SM-690	
	4-0	1.5	30	75	UNDYED	36	Reliapoint™needle	SM-691	
	4-0	1.5	30	75	VIOLET	36	Reliapoint™needle	SM-791	
	4-0	1.5	30	75	UNDYED	12	Reliapoint™needle	SM-691G	
	3-0	2	30		UNDYED	36	Reliapoint™needle	SM822	
	3-0	2	30	75	VIOLET	36	Reliapoint™needle	SM-922	
C-14 3/8 CIRCLE 24mm 	3-0	2	30	75	UNDYED	36	Reliapoint™needle	SM-693	
	2-0	3	30	75	VIOLET	36	Reliapoint™needle	SM-923	
	2-0	3	30	75	UNDYED	36	Reliapoint™needle	SM-823	
C-23 1/2 CIRCLE 24mm 	4-0	1.5	30	75	VIOLET	36	Reliapoint™needle	SM-633	
	3-0	2	18	45	VIOLET	12	5 strands, D-Tach™, Reliapoint™needle	SM-83-M	
	3-0	2	30	75	VIOLET	36	Reliapoint™needle	SM-632	
GS-10 1/2 CIRCLE 26mm 	2-0	3	30	75	VIOLET	36		CM-879	
GS-11 1/2 CIRCLE 37mm 	2-0	3	30	75	VIOLET	36		CM-816	
	2-0	3	30	75	UNDYED	36		CM-543	
	0	3.5	30	75	UNDYED	36		CM-544	
	0	3.5	30	75	VIOLET	36		CM-817	
GS-11 - GS-21 1/2 CIRCLE 37mm (Double armed) (Not to scale) 	3-0	2	54	135	UNDYED	36		CM-991	
	2-0	3	60	150	UNDYED	36		CM-932	
HOS-11 1/2 CIRCLE 37mm 	1	4	30	75	VIOLET	36		CM-528	
GS-13 1/2 CIRCLE 48mm (Not to scale) 	1	4	36	90	VIOLET	36		CM-222	

Surgipro™ II and Surgipro™ 7-0, 8-0; Sofsilik™ 8-0; Polysorb™, Biosyn™, Monosof™, Maxon™, Velosorb™ Fast sutures differ from USP and EP only in diameter. Please refer to IFU for more details.







© 2018 Medtronic. All rights reserved. Medtronic, Medtronic logo and Further, Together are trademarks of Medtronic.

™*Third party brands are trademarks of their respective owners.

All other brands are trademarks of a Medtronic company.

11/2018 US170542

Glycomer™ 631 Monofilament Synthetic Absorbable Sutures

PREMIUM REVERSE CUTTING									
Description	USP Size	EP Size	Length (in)	Length (cm)	Color	Units per box	Comments	Reorder code	
P-10 3/8 CIRCLE 11mm 	6-0	0.7	18	45	UNDYED	12	Edgellant™ needle, Surgalloy™ alloy	SM-3625	
	5-0	1	18	45	UNDYED	12	Edgellant™ needle, Surgalloy™ alloy	SM-3626	
P-13 3/8 CIRCLE 13mm 	6-0	0.7	18	45	UNDYED	12	Edgellant™ needle, Surgalloy™ alloy	SM-5688	
	5-0	1	18	45	UNDYED	12	Edgellant™ needle, Surgalloy™ alloy	SM-5687	
	4-0	1.5	18	45	UNDYED	12	Edgellant™ needle, Surgalloy™ alloy	SM-5690	
P-11 3/8 CIRCLE 16mm 	4-0	1.5	72	180	UNDYED	12		SM-5690-2	
P-12 3/8 CIRCLE 19mm 	5-0	1	18	45	UNDYED	12	Edgellant™ needle, Surgalloy™ alloy	SM-5624	
	4-0	1.5	18	45	UNDYED	12	Edgellant™ needle, Surgalloy™ alloy	SM-5627	
	4-0	1.5	30	75	UNDYED	12	Edgellant™ needle, Surgalloy™ alloy	SM-5637	
	3-0	2	18	45	UNDYED	12	Edgellant™ needle, Surgalloy™ alloy	SM-5628	
	3-0	2	30	75	UNDYED	12	Edgellant™ needle, Surgalloy™ alloy	SM-5638	
P-14 3/8 CIRCLE 24mm 	4-0	1.5	18	45	UNDYED	24	Edgellant™ needle, Surgalloy™ alloy	SM-5679	
	4-0	1.5	30	75	UNDYED	36	Edgellant™ needle, Surgalloy™ alloy	SM-5678	
	3-0	2	30	75	UNDYED	12	Edgellant™ needle, Surgalloy™ alloy	SM-5679G	
P-21 1/2 CIRCLE 9mm 	5-0	1	18	45	UNDYED	36	Edgellant™ needle, Surgalloy™ alloy	SM-1614	

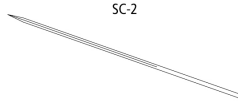
CONVENTIONAL CUTTING									
Description	USP Size	EP Size	Length (in)	Length (cm)	Color	Units per box	Comments	Reorder code	
SC-2 STRAIGHT 60mm (Not to scale) 	4-0	1.5	30	75	UNDYED	36		SM-644	
	3-0	2	30	75	UNDYED	36		SM-643	







Surgipro™ II and Surgipro™ 7-0, 8-0; Sofsilik™ 8-0; Polysorb™, Biosyn™, Monosof™, Maxon™, Velosorb™ Fast sutures differ from USP and EP only in diameter. Please refer to IFU for more details.

© 2018 Medtronic. All rights reserved. Medtronic, Medtronic logo and Further, Together are trademarks of Medtronic.

™*Third party brands are trademarks of their respective owners.

All other brands are trademarks of a Medtronic company.

Glycomer™ 631 Monofilament Synthetic Absorbable Sutures

DERMAX PREMIUM X CUTTING									
Description		USP Size	EP Size	Length (in)	Length (cm)	Color	Units per box	Comments	Reorder code
DX-13 3/8 CIRCLE 13mm	 DX-13 	5-0	1	18	45	UNDYED	12	DermaX	XM-834
DX-16 3/8 CIRCLE 16mm	 DX-16 	4-0	1.5	18	45	UNDYED	12	DermaX	XM-845
DX-19 3/8 CIRCLE 19mm	 DX-19 	5-0	1	18	45	UNDYED	12	DermaX	XM-822
		4-0	1.5	18	45	UNDYED	12	DermaX	XM-823

Surgipro™ II and Surgipro™ 7-0, 8-0; Sofsilik™ 8-0; Polysorb™, Biosyn™, Monosof™, Maxon™, Velosorb™ Fast sutures differ from USP and EP only in diameter. Please refer to IFU for more details.







© 2018 Medtronic. All rights reserved. Medtronic, Medtronic logo and Further, Together are trademarks of Medtronic.

™*Third party brands are trademarks of their respective owners.

All other brands are trademarks of a Medtronic company.

11/2018 US170542

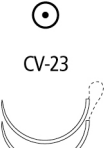
Glycomer™ 631 Monofilament Synthetic Absorbable Sutures

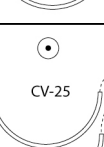
TAPER POINT									
Description		USP Size	EP Size	Length (in)	Length (cm)	Color	Units per box	Comments	Reorder code
CV-11 - CV-11 3/8 CIRCLE 13mm (Double armed)		5-0	1	30	75	VIOLET	36	Surgalloy™	CM-126
CVF-21 1/2 CIRCLE 12mm		5-0	1	18	45	UNDYED	36	Surgalloy™	SM-432
		4-0	1.5	18	45	UNDYED	36	Surgalloy™	SM-431
		4-0	1.5	30	75	UNDYED	36	Surgalloy™	SM-434
CV-22 1/2 CIRCLE 13mm		6-0	0.7	30	75	VIOLET	36	Surgalloy™	UM-986
		6-0	0.7	30	75	UNDYED	36	Surgalloy™	UM-886
		5-0	1	30	75	VIOLET	36	Surgalloy™	GM-875
CV-23 1/2 CIRCLE 17mm		6-0	0.7	30	75	VIOLET	36	Surgalloy™	UM-201
		5-0	1	30	75	UNDYED	36	Surgalloy™	UM-213
		5-0	1	30	75	VIOLET	36	Surgalloy™	UM-202
		4-0	1.5	30	75	UNDYED	36	Surgalloy™	UM-214
		4-0	1.5	30	75	VIOLET	36	Surgalloy™	UM-203
		3-0	2	30	75	VIOLET	36	Surgalloy™	UM-204
		3-0	2	30	75	UNDYED	36	Surgalloy™	UM-215
CV-23 - CV-23 1/2 CIRCLE 17mm (Double armed)		4-0	1.5	30	75	VIOLET	36	Surgalloy™	UM-403
		3-0	2	30	75	VIOLET	36	Surgalloy™	CM-208
CV-25 1/2 CIRCLE 22mm		4-0	1.5	18	45	VIOLET	12	5 strands, D-Tach™	GM-34-M
		4-0	1.5	30	75	VIOLET	12	5 strands, D-Tach™	GM-181-M
		4-0	1.5	30	75	VIOLET	36	Surgalloy™	GM181
		3-0	2	30	75	VIOLET	36	Surgalloy™	GM-324
		2-0	3	30	75	VIOLET	36	Surgalloy™	GM-183
CV-25 - CV-25 1/2 CIRCLE 22mm (Double armed)		4-0	1.5	30	75	VIOLET	36	Surgalloy™	GM-281
		4-0	1.5	36	90	VIOLET	36	Surgalloy™	GM-291
		3-0	2	36	90	VIOLET	36	Surgalloy™	GM-282



Surgipro™ II and Surgipro™ 7-0, 8-0; Sofsil™ 8-0; Polysorb™, Biosyn™, Monosof™, Maxon™, Velosorb™ Fast sutures differ from USP and EP only in diameter. Please refer to IFU for more details.

© 2018 Medtronic. All rights reserved. Medtronic, Medtronic logo and Further, Together are trademarks of Medtronic.

™*Third party brands are trademarks of their respective owners.

All other brands are trademarks of a Medtronic company.

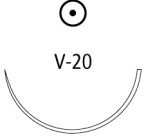
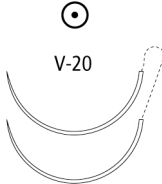
Glycomer™ 631 Monofilament Synthetic Absorbable Sutures

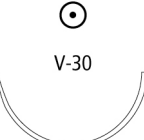
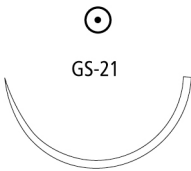
TAPER POINT									
Description	USP Size	EP Size	Length (in)	Length (cm)	Color	Units per box	Comments	Reorder code	
V-20 1/2 CIRCLE 26mm 	4-0	1.5	30	75	VIOLET	36	Surgalloy™	GM-121	
	4-0	1.5	30	75	UNDYED	36	Surgalloy™	GM-321	
	3-0	2	18	45	UNDYED	12	5 strands, D-Tach™	GM-69-M	
	3-0	2	30	75	VIOLET	12	5 strands, D-Tach™	GM-67-M	
	3-0	2	30	75	UNDYED	36	Surgalloy™	GM-322	
	3-0	2	30	75	VIOLET	36	Surgalloy™	GM-122	
	2-0	3	30	75	VIOLET	36	Surgalloy™	GM-123	
	2-0	3	30	75	UNDYED	36	Surgalloy™	GM-323	
	2-0	3	36	90	VIOLET	36	Surgalloy™	GM-125	
V-20 - V-20 1/2 CIRCLE 26mm (Double armed) 	4-0	1.5	30	75	VIOLET	36	Surgalloy™	GM-421	
	4-0	1.5	36	90	VIOLET	36	Surgalloy™	GM-432	
	3-0	2	36	90	VIOLET	36	Surgalloy™	GM-332	
GS-22 1/2 CIRCLE 27mm 	3-0	2	30	75	VIOLET	36		CM-882	
	2-0	3	30	75	UNDYED	36		CM-830	
	2-0	3	30	75	VIOLET	36		CM-883	
	0	3.5	30	75	VIOLET	36		CM-884	
	0	3.5	30	75	UNDYED	36		CM-831	
	1	4	30	75	VIOLET	36		CM-832	
V-30 1/2 CIRCLE 30mm 	3-0	2	30	75	VIOLET	36		GM-222	
	2-0	3	30	75	VIOLET	36		GM-223	
	2-0	3	36	90	VIOLET	36		GM-326	
	0	3.5	36	90	VIOLET	36		GM-327	
GS-21 1/2 CIRCLE 37mm 	3-0	2	18	45	VIOLET	12	5 strands, D-Tach™	CM-738-M	
	3-0	2	30	75	UNDYED	36		CM-842	
	3-0	2	30	75	VIOLET	36		CM-810	
	3-0	2	36	90	VIOLET	36		CM-922	
	2-0	3	18	45	VIOLET	12	5 strands, D-Tach™	CM-9M	
	2-0	3	30	75	UNDYED	36		CM-843	
	2-0	3	30	75	VIOLET	36		CM-811	
	2-0	3	36	90	UNDYED	36		CM-953	
	2-0	3	36	90	VIOLET	36		CM-923	
	0	3.5	18	45	VIOLET	12	5 strands, D-Tach™	CM-10-M	
	0	3.5	18	45	UNDYED	12	5 strands, D-Tach™	CM-14-M	
	0	3.5	30	75	VIOLET	36		CM-812	
	0	3.5	30	75	UNDYED	36		CM-844	
	0	3.5	36	90	VIOLET	36		CM-924	
	0	3.5	36	90	UNDYED	36		CM-954	
	1	4	18	45	VIOLET	12	5 strands, D-Tach™	CM-11-M	
	1	4	30	75	UNDYED	36		CM-845	
	1	4	30	75	VIOLET	36		CM-813	
	1	4	36	90	VIOLET	36		CM-925	

Surgipro™ II and Surgipro™ 7-0, 8-0; Sofsilik™ 8-0; Polysorb™, Biosyn™, Monosof™, Maxon™, Velosorb™ Fast sutures differ from USP and EP only in diameter. Please refer to IFU for more details.







© 2018 Medtronic. All rights reserved. Medtronic, Medtronic logo and Further, Together are trademarks of Medtronic.

™*Third party brands are trademarks of their respective owners.

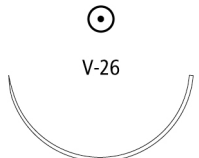
All other brands are trademarks of a Medtronic company.

11/2018 US170542

Glycomer™ 631 Monofilament Synthetic Absorbable Sutures

TAPER POINT									
Description	USP Size	EP Size	Length (in)	Length (cm)	Color	Units per box	Comments	Reorder code	
V-26 1/2 CIRCLE 37mm 	3-0	2	30	75	UNDYED	36		GM-226	
	2-0	3	30	75	UNDYED	36		GM-227	
GS-24 1/2 CIRCLE 40mm 	3-0	2	36	90	UNDYED	36		CM-962	
	2-0	3	30	75	VIOLET	36		CM-801	
	0	3.5	36	90	UNDYED	36		CM-964	
	0	3.5	36	90	VIOLET	36		CM-914	
	1	4	36	90	VIOLET	36		CM-966	
GS-24 LOOP 1/2 CIRCLE 40mm 	0	3.5	60	150	VIOLET	12		CM-765-L	
	1	4	60	150	VIOLET	12	Loop	CM-767L	
GS-25 1/2 CIRCLE 48mm (Not to scale) 	2-0	3	36	90	VIOLET	36		CM-903	
	0	3.5	18	45	VIOLET	12	5 strands, D-Tach™	CM-30-M	
	0	3.5	36	90	VIOLET	36		CM-904	
	0	3.5	36	90	UNDYED	36		CM-974	
	1	4	18	45	VIOLET	12	5 strands, D-Tach™	CM-31-M	
	1	4	36	90	UNDYED	36		CM-975	
GS-25 LOOP 1/2 CIRCLE 48mm (Not to scale) 	0	3.5	60	150	VIOLET	12		CM-790L	
	1	4	60	150	VIOLET	12		CM-776L	
GS-26 LOOP 1/2 CIRCLE 65mm (Not to scale) 	0	3.5	60	150	VIOLET	12		CM-779L	
	1	4	96	240	VIOLET	12		CM-780L	
GU-46 5/8 CIRCLE 27mm 	3-0	2	30	75	VIOLET	36		UM-879	
	2-0	3	30	75	UNDYED	36		UM-978	
	2-0	3	30	75	VIOLET	36		UM-878	
	0	3.5	30	75	VIOLET	36		UM-877	
	0	3.5	30	75	UNDYED	36		UM-977	



Surgipro™ II and Surgipro™ 7-0, 8-0; Sofsilik™ 8-0; Polysorb™, Biosyn™, Monosof™, Maxon™, Velosorb™ Fast sutures differ from USP and EP only in diameter. Please refer to IFU for more details.

© 2018 Medtronic. All rights reserved. Medtronic, Medtronic logo and Further, Together are trademarks of Medtronic.

™*Third party brands are trademarks of their respective owners.

All other brands are trademarks of a Medtronic company.

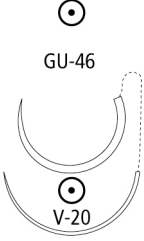
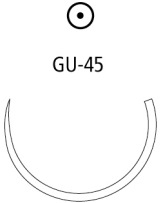
Glycomer™ 631 Monofilament Synthetic Absorbable Sutures

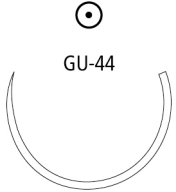
TAPER POINT									
Description	USP Size	EP Size	Length (in)	Length (cm)	Color	Units per box	Comments	Reorder code	
GU-46 - V-20 5/8 CIRCLE 27mm (Double armed)	2-0	3	30	75	VIOLET	36		CM-558	
GU-45 5/8 CIRCLE 37mm	2-0	3	30	75	UNDYED	36		UM-345	
	2-0	3	30	75	VIOLET	36		UM-245	
GU-45 - GU-45 5/8 CIRCLE 37mm (Double armed) (Not to scale)	3-0	2	30	75	VIOLET	36		UM-243	
GU-44 5/8 CIRCLE 40mm	0	3.5	30	75	VIOLET	36		UM-383	

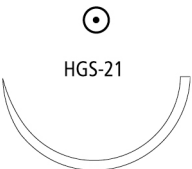
HEAVY TAPER POINT									
Description	USP Size	EP Size	Length (in)	Length (cm)	Color	Units per box	Comments	Reorder code	
HGS-21 1/2 CIRCLE 37mm	0	3.5	30	75	VIOLET	36		CM-436	

Surgipro™ II and Surgipro™ 7-0, 8-0; Sofsilik™ 8-0; Polysorb™, Biosyn™, Monosoft™, Maxon™, Velosorb™ Fast sutures differ from USP and EP only in diameter. Please refer to IFU for more details.

© 2018 Medtronic. All rights reserved. Medtronic, Medtronic logo and Further, Together are trademarks of Medtronic.

™*Third party brands are trademarks of their respective owners.

All other brands are trademarks of a Medtronic company.

11/2018 US170542

Glycomer™ 631 Monofilament Synthetic Absorbable Sutures

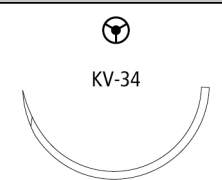
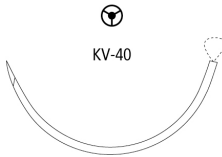
TAPERCUTTING									
Description	USP Size	EP Size	Length (in)	Length (cm)	Color	Units per box	Comments	Reorder code	
KV-34 1/2 CIRCLE 37mm 	2-0	3	30	75	UNDYED	36		CM-827	
KV-40 LOOP 1/2 CIRCLE 48mm (Not to scale) 	1	4	60	150	VIOLET	12	Loop	CM-740L	

Surgipro™ II and Surgipro™ 7-0, 8-0; Sofsil™ 8-0; Polysorb™, Biosyn™, Monosof™, Maxon™, Velosorb™ Fast sutures differ from USP and EP only in diameter. Please refer to IFU for more details.



© 2018 Medtronic. All rights reserved. Medtronic, Medtronic logo and Further, Together are trademarks of Medtronic.

™*Third party brands are trademarks of their respective owners.

All other brands are trademarks of a Medtronic company.

11/2018 US170542

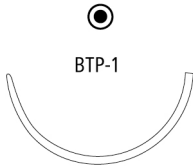
Glycomer™ 631 Monofilament Synthetic Absorbable Sutures

BLUNT TAPER POINT									
Description	USP Size	EP Size	Length (in)	Length (cm)	Color	Units per box	Comments	Reorder code	
BTV-20 1/2 CIRCLE 26mm	3-0	2	30	75	UNDYED	36		GMT-226	
BTP-1 1/2 CIRCLE 37mm	2-0	3	30	75	VIOLET	36	ProtectPoint™	CMT-811	
	0	3.5	18	45	VIOLET	12	5 strands, D-Tach™, ProtectPoint™	CMT-740-M	
	0	3.5	30	75	VIOLET	36		CMT-812	
	0	3.5	36	90	UNDYED	36		CMT-967	
	1	4	18	45	VIOLET	12	5 strands, D-Tach™, ProtectPoint™	CMT-741-M	
BGS-24 1/2 CIRCLE 40mm	1	4	36	90	VIOLET	36	ProtectPoint™	CM-951	
BGS-25 1/2 CIRCLE 48mm (Not to scale)	1	4	18	45	VIOLET	12	5 strands, D-Tach™, ProtectPoint™	CM-949-M	
BTP-X 1/2 CIRCLE 48mm (Not to scale)	0	3.5	18	45	VIOLET	12	5 strands, D-Tach™, ProtectPoint™	CMT-950-M	
	0	3.5	36	90	UNDYED	36		CMT-974	
	1	4	18	45	VIOLET	12	5 strands, D-Tach™, ProtectPoint™	CMT-949-M	
BTP-X LOOP 1/2 CIRCLE 48mm (Not to scale)	0	3.5	60	150	VIOLET	12		CMT-789-L	

PREMIUM CONVENTIONAL CUTTING									
Description	USP Size	EP Size	Length (in)	Length (cm)	Color	Units per box	Comments	Reorder code	
PC-13 3/8 CIRCLE 11mm	5-0	1	18	45	UNDYED	24		CM-401	
	4-0	1.5	18	45	UNDYED	24		CM-400	

Surgipro™ II and Surgipro™ 7-0, 8-0; Sofsilik™ 8-0; Polysorb™, Biosyn™, Monosof™, Maxon™, Velosorb™ Fast sutures differ from USP and EP only in diameter. Please refer to IFU for more details.

© 2018 Medtronic. All rights reserved. Medtronic, Medtronic logo and Further, Together are trademarks of Medtronic.

™*Third party brands are trademarks of their respective owners.

All other brands are trademarks of a Medtronic company.

11/2018 US170542

Glycomer™ 631 Monofilament Synthetic Absorbable Sutures

Reorder Code	Page	Reorder Code	Page	Reorder Code	Page
CM-10-M	68	CM-882	68	GM-222	68
CM-11-M	68	CM-883	68	GM-223	68
CM-126	67	CM-884	68	GM-226	69
CM-14-M	68	CM-903	69	GM-227	69
CM-208	67	CM-904	69	GM-281	67
CM-222	64	CM-905	69	GM-282	67
CM-30-M	69	CM-914	69	GM-291	67
CM-31-M	69	CM-922	68	GM-321	68
CM-400	72	CM-923	68	GM-322	68
CM-401	72	CM-924	68	GM-323	68
CM-436	70	CM-925	68	GM-324	67
CM-528	64	CM-932	64	GM-326	68
CM-543	64	CM-949-M	72	GM-327	68
CM-544	64	CM-951	72	GM-332	68
CM-558	70	CM-953	68	GM-34-M	67
CM-738-M	68	CM-954	68	GM-421	68
CM-740L	71	CM-962	69	GM-432	68
CM-765-L	69	CM-964	69	GM-67-M	68
CM-767L	69	CM-966	69	GM-69-M	68
CM-776L	69	CM-974	69	GM-875	67
CM-779L	69	CM-975	69	GMT-226	72
CM-780L	69	CM-991	64	M-114	63
CM-790L	69	CM-9M	68	M-23-	63
CM-801	69	CMT-740-M	72	M-31-	63
CM-810	68	CMT-741-M	72	M-32-	63
CM-811	68	CMT-789-L	72	M-33-	63
CM-812	68	CMT-811	72	M-72	63
CM-813	68	CMT-812	72	M-74	63
CM-816	64	CMT-949-M	72	M-75	63
CM-817	64	CMT-950-M	72	SM-1614	65
CM-827	71	CMT-967	72	SM-3625	65
CM-830	68	CMT-974	72	SM-3626	65
CM-831	68	GM-121	68	SM-431	67
CM-832	68	GM-122	68	SM-432	67
CM-842	68	GM-123	68	SM-434	67
CM-843	68	GM-125	68	SM-5624	65
CM-844	68	GM181	67	SM-5627	65
CM-845	68	GM-181-M	67	SM-5628	65
CM-879	64	GM-183	67	SM-5637	65

Surgipro™ II and Surgipro™ 7-0, 8-0; Sofsilik™ 8-0; Polysorb™, Biosyn™, Monosof™, Maxon™, Velosorb™ Fast sutures differ from USP and EP only in diameter. Please refer to IFU for more details.

© 2018 Medtronic. All rights reserved. Medtronic, Medtronic logo and Further, Together are trademarks of Medtronic.

™*Third party brands are trademarks of their respective owners.

All other brands are trademarks of a Medtronic company.

Glycomer™ 631 Monofilament Synthetic Absorbable Sutures

Reorder Code	Page	Reorder Code	Page	Reorder Code	Page
SM-5638	65	UM-978	69		
SM-5678	65	UM-986	67		
SM-5679	65	XM-822	66		
SM-5679G	65	XM-823	66		
SM-5687	65	XM-834	66		
SM-5688	65	XM-845	66		
SM-5690	65				
SM-5690-2	65				
SM-632	64				
SM-633	64				
SM-643	65				
SM-644	65				
SM-690	64				
SM-691	64				
SM-691G	64				
SM-693	64				
SM-791	64				
SM822	64				
SM-823	64				
SM-83-M	64				
SM-922	64				
SM-923	64				
UM-201	67				
UM-202	67				
UM-203	67				
UM-204	67				
UM-213	67				
UM-214	67				
UM-215	67				
UM-243	70				
UM-245	70				
UM-345	70				
UM-383	70				
UM-403	67				
UM-877	69				
UM-878	69				
UM-879	69				
UM-886	67				
UM-977	69				

Surgipro™ II and Surgipro™ 7-0, 8-0; Sofsilik™ 8-0; Polysorb™, Biosyn™, Monosof™, Maxon™, Velosorb™ Fast sutures differ from USP and EP only in diameter. Please refer to IFU for more details.

© 2018 Medtronic. All rights reserved. Medtronic, Medtronic logo and Further, Together are trademarks of Medtronic.

™*Third party brands are trademarks of their respective owners.

All other brands are trademarks of a Medtronic company.

11/2018 US170542

MAXON™/MAXON™ CV

Polyglyconate, Monofilament Synthetic Absorbable Sutures

Description	Maxon™ and Maxon™ CV monofilament polyglyconate synthetic absorbable sutures are prepared from a copolymer of glycolic acid and trimethylene carbonate.
Indications	Maxon™ sutures are indicated for use as absorbable sutures in general soft tissue approximation and/or ligation, including use in pediatric cardiovascular tissue, where growth is expected to occur, and in peripheral vascular tissue. Maxon™ sutures are not indicated for use in adult cardiovascular tissue, ophthalmic surgery, microsurgery, and neural tissue.
Actions	Maxon™ and Maxon™ CV synthetic absorbable sutures elicit a minimal acute inflammatory reaction in tissues, which is followed by gradual encapsulation of the suture by fibrous connective tissue. Progressive loss of tensile strength and eventual absorption of Maxon™ synthetic absorbable sutures occurs by means of hydrolysis where the suture is broken down and subsequently absorbed and metabolized by the body.
Tensile Strength	Tensile strength for Maxon™ and Maxon™ CV sutures is approximately 80% of the original suture strength at one week post-implant. Approximately 75% of the original suture strength remains at two weeks, 65% at three weeks, 50% at four weeks and 25% at six weeks post-implant.
Sterilization	Gamma irradiation.
Absorption	Absorption of Maxon™ and Maxon™ CV synthetic absorbable sutures is minimal until about the 60th day after implantation and is essentially complete within six months.
Packaging	Maxon™ sutures are available in USP and E.P sizes 1 (4 Metric) through 7-0 (0.5 Metric). Maxon™ CV sutures are available in USP and E.P sizes 3-0 (1.5 Metric) through 7-0 (0.5 Metric). Maxon™ and Maxon™ CV sutures are dyed with D&C Green No. 6. Maxon™ and Maxon™ CV sutures are also available in clear (Undyed). The sutures are supplied sterile, affixed to various needle types, using permanent needle attachment techniques. Please refer to the individual package IFUs for complete instructions, indications, contraindications, warnings and precautions.

MAXON™/MAXON™ CV

Polyglyconate, Monofilament Synthetic Absorbable Sutures

NON NEEDLED - PRE-CUT								
Description	USP Size	EP Size	Length (in)	Length (cm)	Color	Units per box	Comments	Reorder code
PRE-CUT	3-0	2	18	45	GREEN	36	3 strands	8886600741
	2-0	3	18	45	GREEN	36	3 strands	8886600751
	0	3.5	18	45	GREEN	12	5 strands	8886601563

Surgipro™ II and Surgipro™ 7-0, 8-0; Sofsilik™ 8-0; Polysorb™, Biosyn™, Monosof™, Maxon™, Velosorb™ Fast sutures differ from USP and EP only in diameter. Please refer to IFU for more details.

© 2018 Medtronic. All rights reserved. Medtronic, Medtronic logo and Further, Together are trademarks of Medtronic.







™*Third party brands are trademarks of their respective owners.

All other brands are trademarks of a Medtronic company.

11/2018 US170542

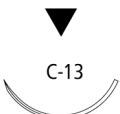
MAXON™/MAXON™ CV

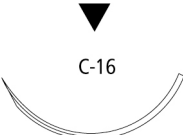
Polyglyconate, Monofilament Synthetic Absorbable Sutures

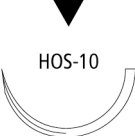
REVERSE CUTTING									
Description	USP Size	EP Size	Length (in)	Length (cm)	Color	Units per box	Comments	Reorder code	
C-1 3/8 CIRCLE 12mm 	5-0	1	18		GREEN	36	Reliapoint™needle	8886660521	
	4-0	1.5	18		GREEN	36	Reliapoint™needle	8886660531	
C-12 3/8 CIRCLE 16mm 	4-0	1.5	30		CLEAR	36	Reliapoint™needle	8886611831	
C-13 3/8 CIRCLE 19mm 	5-0	1	18		CLEAR	36	Reliapoint™needle	8886660821	
	4-0	1.5	30		GREEN	36	Reliapoint™needle	8886663931	
	4-0	1.5	18		CLEAR	36	Reliapoint™needle	8886660831	
	4-0	1.5	30		CLEAR	36	Reliapoint™needle	8886661231	
	3-0	2	18		CLEAR	36	Reliapoint™needle	8886660841	
	3-0	2	30		CLEAR	36	Reliapoint™needle	8886661241	
	3-0	2	30		GREEN	36	Reliapoint™needle	8886663941	
C-14 3/8 CIRCLE 24mm 	4-0	1.5	30		CLEAR	36	Reliapoint™needle	8886661831	
	3-0	2	30		CLEAR	36	Reliapoint™needle	8886661841	
	3-0	2	30		GREEN	36	Reliapoint™needle	8886664141	
	2-0	3	30		GREEN	36	Reliapoint™needle	8886664151	
	2-0	3	30		CLEAR	36	Reliapoint™needle	8886661851	
C-16 3/8 CIRCLE 30mm 	2-0	3	30		CLEAR	36	Reliapoint™needle	8886662651	
C-27 1/2 CIRCLE 20mm 	3-0	2	18		GREEN	36	Reliapoint™needle	8886605941	
GS-10 1/2 CIRCLE 26mm 	3-0	2	30	75	CLEAR	36		8886674441	
	2-0	3	18	45	GREEN	12	5 strands, D-Tach™	CMM-435-MG	
	2-0	3	30	75	CLEAR	36		8886674451	
	2-0	3	30	75	GREEN	36		8886674551	
HOS-10 1/2 CIRCLE 26mm 	1	4	30	75	GREEN	36		88866751-71	

Surgipro™ II and Surgipro™ 7-0, 8-0; Sofsilik™ 8-0; Polysorb™, Biosyn™, Monosof™, Maxon™, Velosorb™ Fast sutures differ from USP and EP only in diameter. Please refer to IFU for more details.

© 2018 Medtronic. All rights reserved. Medtronic, Medtronic logo and Further, Together are trademarks of Medtronic.



™*Third party brands are trademarks of their respective owners.

All other brands are trademarks of a Medtronic company.

11/2018 US170542

MAXON™/MAXON™ CV

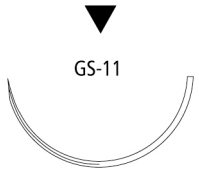
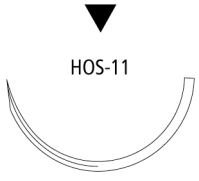
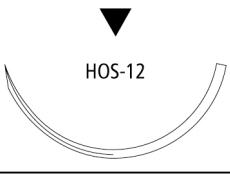
Polyglyconate, Monofilament Synthetic Absorbable Sutures

REVERSE CUTTING								
Description	USP Size	EP Size	Length (in)	Length (cm)	Color	Units per box	Comments	Reorder code
GS-11 1/2 CIRCLE 37mm 	2-0	3	30	75	GREEN	36		8886675551
	0	3.5	30	75	GREEN	36		8886675561
	1	4	30	75	GREEN	36		8886675571
HOS-11 1/2 CIRCLE 37mm 	1	4	30	75	GREEN	36		88866757-71
HOS-12 1/2 CIRCLE 40mm 	1	4	30	75	GREEN	36		8886678771
GS-13 1/2 CIRCLE 48mm (Not to scale) 	1	4	36	90	GREEN	36		8886676971

Surgipro™ II and Surgipro™ 7-0, 8-0; Sofsilik™ 8-0; Polysorb™, Biosyn™, Monosof™, Maxon™, Velosorb™ Fast sutures differ from USP and EP only in diameter. Please refer to IFU for more details.

© 2018 Medtronic. All rights reserved. Medtronic, Medtronic logo and Further, Together are trademarks of Medtronic.







™*Third party brands are trademarks of their respective owners.

All other brands are trademarks of a Medtronic company.

11/2018 US170542

MAXON™/MAXON™ CV

Polyglyconate, Monofilament Synthetic Absorbable Sutures

PREMIUM REVERSE CUTTING									
Description	USP Size	EP Size	Length (in)	Length (cm)	Color	Units per box	Comments	Reorder code	
P-10 3/8 CIRCLE 11mm 	6-0	0.7	18		CLEAR	36	Edgellant™ needle, Surgalloy™ alloy	8886653211	
	6-0	0.7	18		GREEN	36	Edgellant™ needle, Surgalloy™ alloy	8886653311	
	5-0	1	18		CLEAR	36	Edgellant™ needle, Surgalloy™ alloy	8886653221	
P-13 3/8 CIRCLE 13mm 	6-0	0.7	18	45	CLEAR	36	Edgellant™ needle, Surgalloy™ alloy	SMM-5516	
	5-0	1	18	45	CLEAR	36	Edgellant™ needle, Surgalloy™ alloy	SMM-5526	
	4-0	1.5	18	45	CLEAR	36	Edgellant™ needle, Surgalloy™ alloy	SMM-5536	
P-11 3/8 CIRCLE 16mm 	5-0	1	18	45	CLEAR	36	Edgellant™ needle, Surgalloy™ alloy	SMM-5221	
	4-0	1.5	18	45	CLEAR	36	Edgellant™ needle, Surgalloy™ alloy	SMM-5431	
P-12 3/8 CIRCLE 19mm 	5-0	1	18	45	CLEAR	36	Edgellant™ needle, Surgalloy™ alloy	SMM-5042	
	4-0	1.5	18	45	CLEAR	36	Edgellant™ needle, Surgalloy™ alloy	SMM-5043	
	4-0	1.5	18	45	GREEN	36	Edgellant™ needle, Surgalloy™ alloy	SMM-5033	
	4-0	1.5	30	75	CLEAR	36	Edgellant™ needle, Surgalloy™ alloy	SMM-5323	
	3-0	2	30		CLEAR	36	Edgellant™ needle, Surgalloy™ alloy	8886663241	
	3-0	2	18	45	CLEAR	36	Edgellant™ needle, Surgalloy™ alloy	SMM-5044	
P-14 3/8 CIRCLE 24mm 	3-0	2	18	45	CLEAR	36	Edgellant™ needle, Surgalloy™ alloy	SMM-5241	
	2-0	3	18	45	CLEAR	36		8886662451	
P-24 1/2 CIRCLE 16mm 	4-0	1.5	18	45	CLEAR	36	Edgellant™ needle, Surgalloy™ alloy	SMM-5831	

Surgipro™ II and Surgipro™ 7-0, 8-0; Sofsilik™ 8-0; Polysorb™, Biosyn™, Monosof™, Maxon™, Velosorb™ Fast sutures differ from USP and EP only in diameter. Please refer to IFU for more details.

© 2018 Medtronic. All rights reserved. Medtronic, Medtronic logo and Further, Together are trademarks of Medtronic.

™*Third party brands are trademarks of their respective owners.

All other brands are trademarks of a Medtronic company.

11/2018 US170542

MAXON™/MAXON™ CV

Polyglyconate, Monofilament Synthetic Absorbable Sutures

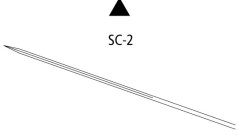
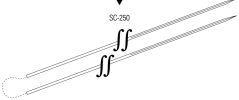
CONVENTIONAL CUTTING									
Description	USP Size	EP Size	Length (in)	Length (cm)	Color	Units per box	Comments	Reorder code	
SC-2 STRAIGHT 60mm (Not to scale) 	4-0	1.5	30	75	CLEAR	36		8886690831	
	3-0	2	30	75	CLEAR	36		8886690841	
SC-250 - SC-250 STRAIGHT 254mm (Double armed) (Not to scale) 	2-0	3	30	75	GREEN	12		8886639053	

Surgipro™ II and Surgipro™ 7-0, 8-0; Sofsilik™ 8-0; Polysorb™, Biosyn™, Monosof™, Maxon™, Velosorb™ Fast sutures differ from USP and EP only in diameter. Please refer to IFU for more details.

© 2018 Medtronic. All rights reserved. Medtronic, Medtronic logo and Further, Together are trademarks of Medtronic.







™*Third party brands are trademarks of their respective owners.

All other brands are trademarks of a Medtronic company.

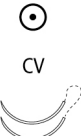
11/2018 US170542

MAXON™/MAXON™ CV

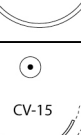
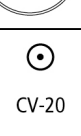
Polyglyconate, Monofilament Synthetic Absorbable Sutures

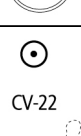
TAPER POINT									
Description		USP Size	EP Size	Length (in)	Length (cm)	Color	Units per box	Comments	Reorder code
CV-1 - CV-1 3/8 CIRCLE 9mm (Double armed)		7-0	0.5	18	45	GREEN	36	Surgalloy™	8886614501
		7-0	0.5	24	60	GREEN	36	Surgalloy™	8886613901
		7-0	0.5	30	75	GREEN	36	Surgalloy™	8886612701
		6-0	0.7	24	60	GREEN	36	Surgalloy™	8886613911
		6-0	0.7	30	75	GREEN	36	Surgalloy™	8886612711
CV - CV 3/8 CIRCLE 11mm (Double armed)		6-0	0.7	18	45	GREEN	36	Surgalloy™	8886611511
CV-11 3/8 CIRCLE 13mm		6-0	0.7	30	75	GREEN	36	Surgalloy™	8886614811
		5-0	1	30	75	GREEN	36	Surgalloy™	8886614821
CV-11 - CV-11 3/8 CIRCLE 13mm (Double armed)		6-0	0.7	18	45	GREEN	36	Surgalloy™	8886612111
		6-0	0.7	24	60	GREEN	36	Surgalloy™	8886614711
		6-0	0.7	30	75	GREEN	36	Surgalloy™	8886612411
		5-0	1	24	60	GREEN	36	Surgalloy™	8886614721
		5-0	1	24	60	GREEN	12	4 strands, Surgalloy™	8886616523
		5-0	1	30	75	GREEN	36	Surgalloy™	8886612421
		5-0	1	36	90	GREEN	36	Surgalloy™	8886612821
CV-15 3/8 CIRCLE 17mm		4-0	1.5	30	75	GREEN	36	Surgalloy™	8886605731
CV-15 - CV-15 3/8 CIRCLE 17mm (Double armed)		5-0	1	30	75	GREEN	36	Surgalloy™	8886646221
		4-0	1.5	30	75	GREEN	36	Surgalloy™	8886646231
CV-20 1/2 CIRCLE 10mm		6-0	0.7	30	75	GREEN	36	Surgalloy™	8886600111
CV-22 1/2 CIRCLE 13mm		6-0	0.7	30	75	GREEN	36	Surgalloy™	8886621311
		5-0	1	30	75	GREEN	36	Surgalloy™	8886621321
		4-0	1.5	18	45	GREEN	12	5 strands, D- Tach™	8886620133
		4-0	1.5	30	75	GREEN	36	Surgalloy™	8886621331
CV-22 - CV-22 1/2 CIRCLE 13mm (Double armed)		6-0	0.7	24	60	GREEN	36	Surgalloy™	8886613111
		6-0	0.7	30	75	GREEN	36	Surgalloy™	8886613211
		5-0	1	30	75	GREEN	36	Surgalloy™	8886612221

Surgipro™ II and Surgipro™ 7-0, 8-0; Sofsilik™ 8-0; Polysorb™, Biosyn™, Monosof™, Maxon™, Velosorb™ Fast sutures differ from USP and EP only in diameter. Please refer to IFU for more details.

© 2018 Medtronic. All rights reserved. Medtronic, Medtronic logo and Further, Together are trademarks of Medtronic.





™*Third party brands are trademarks of their respective owners.

All other brands are trademarks of a Medtronic company.

11/2018 US170542

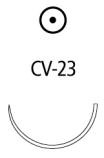
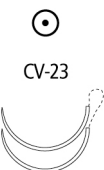
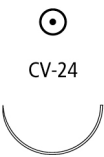
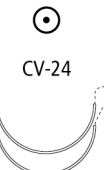
MAXON™/MAXON™ CV

Polyglyconate, Monofilament Synthetic Absorbable Sutures

TAPER POINT									
Description		USP Size	EP Size	Length (in)	Length (cm)	Color	Units per box	Comments	Reorder code
CV-23 1/2 CIRCLE 17mm		5-0	1	30	75	GREEN	36	Surgalloy™	8886620721
		4-0	1.5	30	75	GREEN	36	Surgalloy™	8886620731
		3-0	2	30	75	GREEN	36	Surgalloy™	8886620741
CV-23 - CV-23 1/2 CIRCLE 17mm (Double armed)		5-0	1	30	75	GREEN	36	Surgalloy™	8886614921
		4-0	1.5	36	90	GREEN	36	Surgalloy™	8886613431
CV-24 1/2 CIRCLE 20mm		5-0	1	30	75	GREEN	36		8886621721
		4-0	1.5	18	45	GREEN	12	5 strands, D-Tach™	8886621933
		4-0	1.5	30	75	GREEN	36		8886621731
		3-0	2	18	45	GREEN	12	5 strands, D-Tach™	8886621943
		3-0	2	30	75	GREEN	36		8886621741
CV-24 - CV-24 1/2 CIRCLE 20mm (Double armed)		4-0	1.5	36	90	GREEN	36		8886622131
		3-0	2	36	90	GREEN	36		8886603641
V-20 1/2 CIRCLE 26mm		4-0	1.5	18	45	GREEN	12	5 strands, D-Tach™	8886622933
		4-0	1.5	30	75	GREEN	12	5 strands, D-Tach™	8886603433
		4-0	1.5	30	75	GREEN	36	Surgalloy™	8886623331
		3-0	2	18	45	GREEN	12	5 strands, D-Tach™	8886622943
		3-0	2	30	75	GREEN	12	5 strands, D-Tach™	8886603443
		3-0	2	30	75	GREEN	36	Surgalloy™	8886623341
		3-0	2	30	75	CLEAR	36	Surgalloy™	8886623241
		2-0	3	18	45	GREEN	12	5 strands, D-Tach™	8886622953
		2-0	3	30	75	GREEN	36		8886623351
V-20 - V-20 1/2 CIRCLE 26mm (Double armed)		4-0	1.5	30	75	GREEN	36	Surgalloy™	8886623131
		4-0	1.5	36	90	GREEN	36	Surgalloy™	8886623531
		4-0	1.5	42	105	GREEN	36		8886614331
		3-0	2	36	90	GREEN	36		8886623541
GS-22 1/2 CIRCLE 27mm		3-0	2	30	75	GREEN	36		8886624541
		2-0	3	18	45	GREEN	12	5 strands, D-Tach™	8886624753
		2-0	3	30	75	GREEN	36		8886624551
		0	3.5	30	75	GREEN	36		8886624561
		1	4	30	75	GREEN	36		8886624571

Surgipro™ II and Surgipro™ 7-0, 8-0; Sofsilik™ 8-0; Polysorb™, Biosyn™, Monosof™, Maxon™, Velosorb™ Fast sutures differ from USP and EP only in diameter. Please refer to IFU for more details.

© 2018 Medtronic. All rights reserved. Medtronic, Medtronic logo and Further, Together are trademarks of Medtronic.





™*Third party brands are trademarks of their respective owners.

All other brands are trademarks of a Medtronic company.

11/2018 US170542

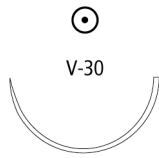
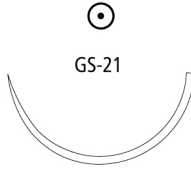
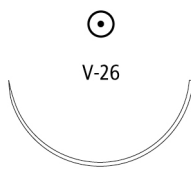
MAXON™/MAXON™ CV

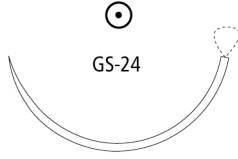
Polyglyconate, Monofilament Synthetic Absorbable Sutures

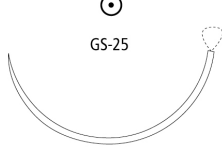
TAPER POINT									
Description	USP Size	EP Size	Length (in)	Length (cm)	Color	Units per box	Comments	Reorder code	
V-30 1/2 CIRCLE 30mm 	4-0	1.5	30	75	GREEN	36		8886626131	
	3-0	2	30	75	GREEN	36		8886626141	
	2-0	3	30	75	GREEN	36		8886626151	
	0	3.5	30	75	GREEN	36		8886626161	
GS-21 1/2 CIRCLE 37mm 	3-0	2	30	75	GREEN	36		8886626741	
	2-0	3	18	45	GREEN	12	5 strands, D-Tach™	8886627553	
	2-0	3	30	75	GREEN	36		8886626751	
	2-0	3	36	90	GREEN	36		8886626951	
	2-0	3	36	90	CLEAR	36		8886626851	
	2-0	3	60	150	GREEN	12		GMM-951	
	0	3.5	18	45	GREEN	12	5 strands, D-Tach™	8886627563	
	0	3.5	30	75	GREEN	36		8886626761	
	0	3.5	36	90	GREEN	36		8886626961	
	1	4	18	45	GREEN	12	5 strands, D-Tach™	8886627573	
	1	4	30	75	GREEN	36		8886626771	
1	4	36	90	GREEN	36		8886626971		
V-26 1/2 CIRCLE 37mm 	3-0	2	30	75	GREEN	36		8886625741	
	2-0	3	30	75	GREEN	36		8886625751	
	0	3.5	30	75	GREEN	36		8886625761	
GS-24 1/2 CIRCLE 40mm 	2-0	3	36	90	GREEN	36		8886628751	
	0	3.5	30	75	GREEN	36		8886628561	
	0	3.5	36	90	GREEN	36		8886628761	
	1	4	30	75	GREEN	36		8886628571	
	1	4	36	90	GREEN	36		8886628771	
GS-24 LOOP 1/2 CIRCLE 40mm 	0	3.5	60	150	GREEN	12		GMM-563L	
	1	4	60	150	GREEN	12		GMM-573L	
GS-25 1/2 CIRCLE 48mm (Not to scale) 	0	3.5	18	45	GREEN	12	5 strands, D-Tach™	8886631163	
	0	3.5	36	90	GREEN	36		8886630761	
	1	4	18	45	GREEN	12	5 strands, D-Tach™	8886631173	
	1	4	36	90	GREEN	36		8886630771	
	1	4	60	150	GREEN	24		8886630972	
GS-25 LOOP 1/2 CIRCLE 48mm (Not to scale) 	0	3.5	60	150	GREEN	12		GMM-634L	
	1	4	60	150	GREEN	12		GMM-632L	

Surgipro™ II and Surgipro™ 7-0, 8-0; Sofsilik™ 8-0; Polysorb™, Biosyn™, Monosof™, Maxon™, Velosorb™ Fast sutures differ from USP and EP only in diameter. Please refer to IFU for more details.

© 2018 Medtronic. All rights reserved. Medtronic, Medtronic logo and Further, Together are trademarks of Medtronic.



™*Third party brands are trademarks of their respective owners.

All other brands are trademarks of a Medtronic company.

11/2018 US170542

MAXON™/MAXON™ CV

Polyglyconate, Monofilament Synthetic Absorbable Sutures

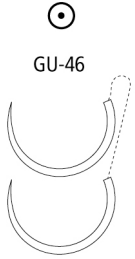
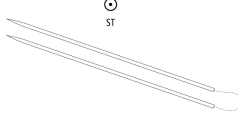
TAPER POINT									
Description	USP Size	EP Size	Length (in)	Length (cm)	Color	Units per box	Comments	Reorder code	
GS-26 1/2 CIRCLE 65mm (Not to scale)		0	3.5	60	150	GREEN	24		8886631962
		1	4	40	100	GREEN	36		8886632271
		1	4	60	150	GREEN	24		8886631972
GS-26 LOOP 1/2 CIRCLE 65mm (Not to scale)		0	3.5	60	150	GREEN	12	Loop	GMM-341L
		0	3.5	96	240	GREEN	12		GMM-343L
		1	4	96	240	GREEN	12		GMM-344L
GU-46 5/8 CIRCLE 27mm		2-0	3	30	75	GREEN	36		8886640351
GU-46 - GU-46 5/8 CIRCLE 27mm (Double armed)		2-0	3	30	75	GREEN	36		8886640451
ST - ST STRAIGHT 60mm (Double armed) (Not to scale)		3-0	2	30	75	GREEN	36		8886623741
		0	3.5	30	75	GREEN	36		8886623761

Surgipro™ II and Surgipro™ 7-0, 8-0; Sofsilik™ 8-0; Polysorb™, Biosyn™, Monosof™, Maxon™, Velosorb™ Fast sutures differ from USP and EP only in diameter. Please refer to IFU for more details.

© 2018 Medtronic. All rights reserved. Medtronic, Medtronic logo and Further, Together are trademarks of Medtronic.



™*Third party brands are trademarks of their respective owners.

All other brands are trademarks of a Medtronic company.

11/2018 US170542

MAXON™/MAXON™ CV

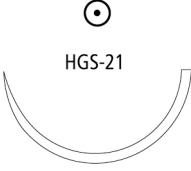
Polyglyconate, Monofilament Synthetic Absorbable Sutures

HEAVY TAPER POINT								
Description	USP Size	EP Size	Length (in)	Length (cm)	Color	Units per box	Comments	Reorder code
HGS-22 1/2 CIRCLE 27mm  HGS-22	0	3.5	30	75	GREEN	36		8886624961
HGS-21 1/2 CIRCLE 37mm  HGS-21	0	3.5	36	90	GREEN	36		8886633961
	1	4	36	90	GREEN	36		88866339-71
HGU-46 5/8 CIRCLE 27mm  HGU-46	0	3.5	18	45	GREEN	36		8886645561
	0	3.5	30	75	GREEN	36		8886645661
	1	4	30	75	GREEN	36		8886641971

Surgipro™ II and Surgipro™ 7-0, 8-0; Sofsilik™ 8-0; Polysorb™, Biosyn™, Monosof™, Maxon™, Velosorb™ Fast sutures differ from USP and EP only in diameter. Please refer to IFU for more details.

© 2018 Medtronic. All rights reserved. Medtronic, Medtronic logo and Further, Together are trademarks of Medtronic.







™*Third party brands are trademarks of their respective owners.

All other brands are trademarks of a Medtronic company.

11/2018 US170542

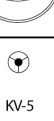
MAXON™/MAXON™ CV

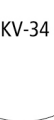
Polyglyconate, Monofilament Synthetic Absorbable Sutures

TAPERCUTTING									
Description		USP Size	EP Size	Length (in)	Length (cm)	Color	Units per box	Comments	Reorder code
KV-1 3/8 CIRCLE 9mm		6-0	0.7	30	75	GREEN	36	Surgalloy™	88866768-11
KV-11 3/8 CIRCLE 13mm		6-0	0.7	30	75	GREEN	36	Surgalloy™	88866297-11
		5-0	1	30	75	GREEN	36		88866297-21
KV-11 - KV-11 3/8 CIRCLE 13mm (Double armed)		6-0	0.7	30	75	GREEN	36	Surgalloy™	88866288-11
		5-0	1	30	75	GREEN	36		88866288-21
KV-5 - KV-5 1/2 CIRCLE 17mm (Double armed)		4-0	1.5	36	90	GREEN	36	Surgalloy™	VMM-137
KV-7 1/2 CIRCLE 26mm		2-0	3	30	75	GREEN	36		88866292-51
KV-34 1/2 CIRCLE 37mm		0	3.5	36	90	GREEN	36		8886627761
		1	4	36	90	GREEN	36		8886627771
		1	4	36	90	GREEN	36		88866277-71
KV-37 LOOP 1/2 CIRCLE 40mm		1	4	60	150	GREEN	12	Loop	GMM-873L
KV-40 1/2 CIRCLE 48mm (Not to scale)		1	4	36	90	GREEN	36		8886629571

Surgipro™ II and Surgipro™ 7-0, 8-0; Sofsil™ 8-0; Polysorb™, Biosyn™, Monosof™, Maxon™, Velosorb™ Fast sutures differ from USP and EP only in diameter. Please refer to IFU for more details.

© 2018 Medtronic. All rights reserved. Medtronic, Medtronic logo and Further, Together are trademarks of Medtronic.

™*Third party brands are trademarks of their respective owners.





All other brands are trademarks of a Medtronic company.

11/2018 US170542

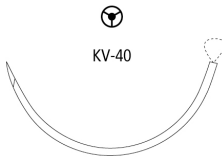
MAXON™/MAXON™ CV

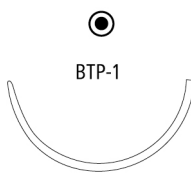
Polyglyconate, Monofilament Synthetic Absorbable Sutures

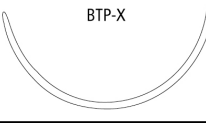
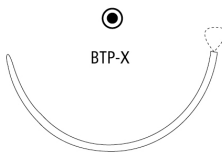
TAPERCUTTING										
Description	USP Size	EP Size	Length (in)	Length (cm)	Color	Units per box	Comments	Reorder code		
KV-40 LOOP 1/2 CIRCLE 48mm (Not to scale)		KV-40	0	3.5	60	150	GREEN	12	Loop	GMM-806L
			1	4	60	150	GREEN	12	Loop	GMM-807L

BLUNT TAPER POINT										
Description	USP Size	EP Size	Length (in)	Length (cm)	Color	Units per box	Comments	Reorder code		
BTP-1 1/2 CIRCLE 37mm		BTP-1	2-0	3	36	90	GREEN	36	Protect Point™	GMMT-951
			0	3.5	18	45	GREEN	12	5 strands, D-Tach™, ProtectPoint™	GMMT-563-MG
			0	3.5	36	90	GREEN	36	Protect Point™	GMMT-961
BGS-25 1/2 CIRCLE 48mm (Not to scale)		BGS-25	0	3.5	36	90	GREEN	12	Protect Point™	8886606163
			1	4	36	90	GREEN	12	Protect Point™	8886606173
BTP-X 1/2 CIRCLE 48mm (Not to scale)		BTP-X	0	3.5	18	45	GREEN	12	5 strands, D-Tach™, ProtectPoint™	GMMT-541-MG
			1	4	18	45	GREEN	12	5 strands, D-Tach™, ProtectPoint™	GMMT-540-MG
BTP-X LOOP 1/2 CIRCLE 48mm (Not to scale)		BTP-X	0	3.5	60	150	GREEN	12		GMMT-89L
			1	4	60	150	GREEN	12	Protect Point™	GMMT-90L
BGS-29 1/2 CIRCLE 63mm (Not to scale)		BGS-29	1	4	60	150	GREEN	12	Protect Point™	8886606773
BGST-29 LOOP 1/2 CIRCLE 65mm (Not to scale)		BGST-29	1	4	96	240	GREEN	12	Protect Point™	GMMT-690L

Surgipro™ II and Surgipro™ 7-0, 8-0; Sofsilik™ 8-0; Polysorb™, Biosyn™, Monosof™, Maxon™, Velosorb™ Fast sutures differ from USP and EP only in diameter. Please refer to IFU for more details.

© 2018 Medtronic. All rights reserved. Medtronic, Medtronic logo and Further, Together are trademarks of Medtronic.

™*Third party brands are trademarks of their respective owners.

All other brands are trademarks of a Medtronic company.

11/2018 US170542

MAXON™/MAXON™ CV

Polyglyconate, Monofilament Synthetic Absorbable Sutures

MULTIPURPOSE									
Description	USP Size	EP Size	Length (in)	Length (cm)	Color	Units per box	Comments	Reorder code	
5.65 LOOP 5/8 CIRCLE 65mm (Not to scale)	0	3.5	60	150	GREEN	12	Loop	GMM-496L	
	1	4	72	180	GREEN	12	Loop	GMM-497L	

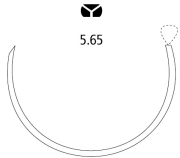

PREMIUM SPATULA									
Description	USP Size	EP Size	Length (in)	Length (cm)	Color	Units per box	Comments	Reorder code	
DGE-6 3/8 CIRCLE 8mm	7-0	0.5	18	45	GREEN	36		8886662801	



Surgipro™ II and Surgipro™ 7-0, 8-0; Sofsilik™ 8-0; Polysorb™, Biosyn™, Monosof™, Maxon™, Velosorb™ Fast sutures differ from USP and EP only in diameter. Please refer to IFU for more details.

© 2018 Medtronic. All rights reserved. Medtronic, Medtronic logo and Further, Together are trademarks of Medtronic.

™*Third party brands are trademarks of their respective owners.

All other brands are trademarks of a Medtronic company.

11/2018 US170542

MAXON™/MAXON™ CV

Polyglyconate, Monofilament Synthetic Absorbable Sutures

Reorder Code	Page	Reorder Code	Page	Reorder Code	Page
8886600111	82	8886621321	82	8886626961	84
8886600741	77	8886621331	82	8886626971	84
8886600751	77	8886621721	83	8886627553	84
8886601563	77	8886621731	83	8886627563	84
8886603433	83	8886621741	83	8886627573	84
8886603443	83	8886621933	83	8886627761	87
8886603641	83	8886621943	83	8886627771	87
8886605731	82	8886622131	83	88866277-71	87
8886605941	78	8886622933	83	8886628561	84
8886606163	88	8886622943	83	8886628571	84
8886606173	88	8886622953	83	8886628751	84
8886606773	88	8886623131	83	8886628761	84
8886611511	82	8886623241	83	8886628771	84
8886611831	78	8886623331	83	88866288-11	87
8886612111	82	8886623341	83	88866288-21	87
8886612221	82	8886623351	83	88866292-51	87
8886612411	82	8886623531	83	8886629571	87
8886612421	82	8886623541	83	88866297-11	87
8886612701	82	8886623741	85	88866297-21	87
8886612711	82	8886623761	85	8886630761	84
8886612821	82	8886624541	83	8886630771	84
8886613111	82	8886624551	83	8886630972	84
8886613211	82	8886624561	83	8886631163	84
8886613431	83	8886624571	83	8886631173	84
8886613901	82	8886624753	83	8886631962	85
8886613911	82	8886624961	86	8886631972	85
8886614331	83	8886625741	84	8886632271	85
8886614501	82	8886625751	84	8886633961	86
8886614711	82	8886625761	84	88866339-71	86
8886614721	82	8886626131	84	8886639053	81
8886614811	82	8886626141	84	8886640351	85
8886614821	82	8886626151	84	8886640451	85
8886614921	83	8886626161	84	8886641971	86
8886616523	82	8886626741	84	8886645561	86
8886620133	82	8886626751	84	8886645661	86
8886620721	83	8886626761	84	8886646221	82
8886620731	83	8886626771	84	8886646231	82
8886620741	83	8886626851	84	8886653211	80
8886621311	82	8886626951	84	8886653221	80

Surgipro™ II and Surgipro™ 7-0, 8-0; Sofsilik™ 8-0; Polysorb™, Biosyn™, Monosof™, Maxon™, Velosorb™ Fast sutures differ from USP and EP only in diameter. Please refer to IFU for more details.

© 2018 Medtronic. All rights reserved. Medtronic, Medtronic logo and Further, Together are trademarks of Medtronic.

™*Third party brands are trademarks of their respective owners.

All other brands are trademarks of a Medtronic company.

11/2018 US170542

MAXON™/MAXON™ CV

Polyglyconate, Monofilament Synthetic Absorbable Sutures

Reorder Code	Page	Reorder Code	Page	Reorder Code	Page
8886653311	80	GMM-573L	84		
8886660521	78	GMM-632L	84		
8886660531	78	GMM-634L	84		
8886660821	78	GMM-806L	88		
8886660831	78	GMM-807L	88		
8886660841	78	GMM-873L	87		
8886661231	78	GMM-951	84		
8886661241	78	GMMT-540-MG	88		
8886661831	78	GMMT-541-MG	88		
8886661841	78	GMMT-563-MG	88		
8886661851	78	GMMT-690L	88		
8886662451	80	GMMT-89L	88		
8886662651	78	GMMT-90L	88		
8886662801	89	GMMT-951	88		
8886663241	80	GMMT-961	88		
8886663931	78	SMM-5033	80		
8886663941	78	SMM-5042	80		
8886664141	78	SMM-5043	80		
8886664151	78	SMM-5044	80		
8886674441	78	SMM-5221	80		
8886674451	78	SMM-5241	80		
8886674551	78	SMM-5323	80		
88866751-71	78	SMM-5431	80		
8886675551	79	SMM-5516	80		
8886675561	79	SMM-5526	80		
8886675571	79	SMM-5536	80		
88866757-71	79	SMM-5831	80		
88866768-11	87	VMM-137	87		
8886676971	79				
8886678771	79				
8886690831	81				
8886690841	81				
CMM-435-MG	78				
GMM-341L	85				
GMM-343L	85				
GMM-344L	85				
GMM-496L	89				
GMM-497L	89				
GMM-563L	84				

Surgipro™ II and Surgipro™ 7-0, 8-0; Sofsilik™ 8-0; Polysorb™, Biosyn™, Monosof™, Maxon™, Velosorb™ Fast sutures differ from USP and EP only in diameter. Please refer to IFU for more details.

© 2018 Medtronic. All rights reserved. Medtronic, Medtronic logo and Further, Together are trademarks of Medtronic.

™*Third party brands are trademarks of their respective owners.

All other brands are trademarks of a Medtronic company.

11/2018 US170542

CHROMIC GUT

Absorbable sutures composed of purified connective tissue derived from the serosal layer of bovine intestines

Description	Plain, Chromic and Mild Chromic Gut Absorbable Sutures are absorbable sterile surgical sutures composed of purified connective tissue (mostly collagen) derived from the serosal layer of beef (bovine) intestines. They are packaged in a solution of 89% isopropanol, 10% water and 1% triethanolamine. Chromic gut is treated with chromic salt solution.
Indications	Plain, Chromic and Mild Chromic Gut Absorbable Sutures are indicated for use in general soft tissue approximation and/or ligation, including use in ophthalmic surgery, but not for use in cardiovascular or neurological surgery.
Actions	When Plain, Chromic and Mild Chromic Gut Absorbable Sutures are placed in tissue, a moderate tissue inflammation occurs characteristic of foreign body response to a substance.
Tensile Strength	Gradual loss of tensile strength and suture mass, as the enzymatic process dissolves the surgical gut until it is completely absorbed.
Sterilization	Gamma irradiation
Absorption	Many variable factors may affect the rate of absorption. Some of the major factors which may affect tensile strength loss and absorption rates are: 1. Type of Suture - Plain gut is expected to absorb more rapidly than chromic gut. 2. Infection - Surgical gut is absorbed faster in infected tissue than in noninfected tissue. 3. Tissue Sites - Surgical gut will absorb more rapidly in tissue where increased levels of enzymes are present, as in secretions exhibited in the stomach, cervix and vagina.
Packaging	Plain, Chromic and Mild Chromic Gut Absorbable Sutures are available in sizes 2 (6 Metric) through 7-0 (0.7 Metric) in chromic gut and in sizes 2 (6 Metric) through 6-0 (1 Metric) in plain gut. The sutures are supplied sterile, in pre-cut lengths and ligating reels, non-needled or affixed to various needle types using both permanent and removable needle attachment techniques. The sutures are available in box quantities of one, two and three dozen.

CHROMIC GUT

Absorbable sutures composed of purified connective tissue derived from the serosal layer of bovine intestines

NON NEEDED - PRE-CUT									
Description	USP Size	EP Size	Length (in)	Length (cm)	Color	Units per box	Comments	Reorder code	
PRE-CUT	3-0	2	18	45	UNDYED	24	3 strands	G-82	
	2-0	3	18	45	UNDYED	24	12 strands	G-13	
	2-0	3	30	75	UNDYED	24	2 strands	G-253	
	0	3.5	18	45	UNDYED	24	6 strands	G-14	
	0	3.5	30	75	UNDYED	24	2 strands	G-254	
	1	4	18	45	UNDYED	24	6 strands	G-15	

NON NEEDED - STANDARD LENGTH									
Description	USP Size	EP Size	Length (in)	Length (cm)	Color	Units per box	Comments	Reorder code	
STANDARD LENGTH	2	5	60	150	UNDYED	24	Standard Length	G-216	

NON NEEDED - REEL									
Description	USP Size	EP Size	Length (in)	Length (cm)	Color	Units per box	Comments	Reorder code	
REEL	4-0	1.5	60	150	UNDYED	24		LG-111	
	3-0	2	60	150	UNDYED	24		LG-112	
	2-0	3	60	150	UNDYED	24		LG-113	
	0	3.5	60	150	UNDYED	24		LG-114	
	1	4	60	150	UNDYED	24		LG-115	

Surgipro™ II and Surgipro™ 7-0, 8-0; Sofsilik™ 8-0; Polysorb™, Biosyn™, Monosof™, Maxon™, Velosorb™ Fast sutures differ from USP and EP only in diameter. Please refer to IFU for more details.

© 2018 Medtronic. All rights reserved. Medtronic, Medtronic logo and Further, Together are trademarks of Medtronic.







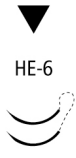

™*Third party brands are trademarks of their respective owners.

All other brands are trademarks of a Medtronic company.

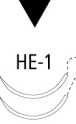
11/2018 US170542

CHROMIC GUT

Absorbable sutures composed of purified connective tissue derived from the serosal layer of bovine intestines

REVERSE CUTTING									
Description	USP Size	EP Size	Length (in)	Length (cm)	Color	Units per box	Comments	Reorder code	
HE-6 - HE-6 3/8 CIRCLE 7.4mm (Double armed) 	6-0	0.7	18	45	UNDYED	12	Surgalloy™	G-1794K	
HE-1 3/8 CIRCLE 11mm 	6-0	0.7	18	45	UNDYED	12	Surgalloy™	G-1780K	
HE-1 - HE-1 3/8 CIRCLE 11mm (Double armed) 	6-0	0.7	18	45	UNDYED	12	Surgalloy™	G-1790K	
C-1 3/8 CIRCLE 12mm 	5-0	1	18	45	UNDYED	36		SG-197	
HE-3 3/8 CIRCLE 13mm 	4-0	1.5	12	30	UNDYED	12	Surgalloy™	G-1752GK	
HE-3 - HE-3 3/8 CIRCLE 13mm (Double armed) 	5-0	1	18	45	UNDYED	12	Surgalloy™	G-1792K	
	4-0	1.5	18	45	UNDYED	12	Surgalloy™	G-1793K	
C-12 3/8 CIRCLE 16mm 	4-0	1.5	18	45	UNDYED	36	Reliapoint™needle	SG-535	
C-13 3/8 CIRCLE 19mm 	5-0	1	30	75	UNDYED	36		SG-634	
	4-0	1.5	18	45	UNDYED	36		SG-675	
	4-0	1.5	30	75	UNDYED	36	Reliapoint™needle	SG-635	
	3-0	2	18	45	UNDYED	36		SG-676	
	3-0	2	30	75	UNDYED	36	Reliapoint™needle	SG-636	
C-14 3/8 CIRCLE 24mm 	2-0	3	30	75	UNDYED	36	Reliapoint™needle	SG-637	

Surgipro™ II and Surgipro™ 7-0, 8-0; Sofsilik™ 8-0; Polysorb™, Biosyn™, Monosof™, Maxon™, Velosorb™ Fast sutures differ from USP and EP only in diameter. Please refer to IFU for more details.

© 2018 Medtronic. All rights reserved. Medtronic, Medtronic logo and Further, Together are trademarks of Medtronic.





™*Third party brands are trademarks of their respective owners.

All other brands are trademarks of a Medtronic company.

11/2018 US170542

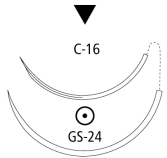
CHROMIC GUT

Absorbable sutures composed of purified connective tissue derived from the serosal layer of bovine intestines

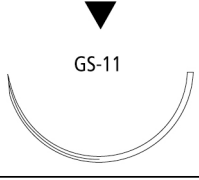
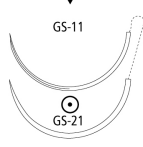
REVERSE CUTTING										
Description	USP Size	EP Size	Length (in)	Length (cm)	Color	Units per box	Comments	Reorder code		
C-16 - GS-24 3/8 CIRCLE 30mm (Double armed) (Not to scale)			2-0		3	60	150	UNDYED	36	CG-977
HE-2 - HE-2 1/2 CIRCLE 8.6mm (Double armed)			4-0		1.5	18	45	UNDYED	12	Surgalloy™ G-1758K
C-21 - C-21 1/2 CIRCLE 13mm (Double armed)			4-0		1.5	18	45	UNDYED	12	G-1744
GS-10 1/2 CIRCLE 26mm			3-0		2	30	75	UNDYED	36	CG-415
GS-11 1/2 CIRCLE 37mm			3-0		2	30	75	UNDYED	36	CG-815
			2-0		3	30	75	UNDYED	36	CG-816
			0		3.5	30	75	UNDYED	36	CG-817
GS-11 - GS-21 1/2 CIRCLE 37mm (Double armed) (Not to scale)			3-0		2	60	150	UNDYED	36	CG-982
			2-0		3	60	150	UNDYED	36	CG-983

Surgipro™ II and Surgipro™ 7-0, 8-0; Sofsilik™ 8-0; Polysorb™, Biosyn™, Monosof™, Maxon™, Velosorb™ Fast sutures differ from USP and EP only in diameter. Please refer to IFU for more details.

© 2018 Medtronic. All rights reserved. Medtronic, Medtronic logo and Further, Together are trademarks of Medtronic.

™*Third party brands are trademarks of their respective owners.

All other brands are trademarks of a Medtronic company.

CHROMIC GUT

Absorbable sutures composed of purified connective tissue derived from the serosal layer of bovine intestines

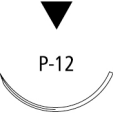
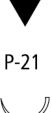
PREMIUM REVERSE CUTTING									
Description	USP Size	EP Size	Length (in)	Length (cm)	Color	Units per box	Comments	Reorder code	
P-13 3/8 CIRCLE 13mm 	5-0	1	18	45	UNDYED	36	Edgellant™ needle, Surgalloy™ alloy	SG-5687	
	5-0	1	18	45	UNDYED	12	Surgalloy™	SG-5687G	
	4-0	1.5	18		UNDYED	12	Edgellant™ needle, Surgalloy™ alloy	SG-5644G	
	4-0	1.5	18	45	UNDYED	36	Surgalloy™	SG-5644	
P-12 3/8 CIRCLE 19mm 	4-0	1.5	18		UNDYED	12	Edgellant™ needle, Surgalloy™ alloy	SG-5637G	
	4-0	1.5	18	45	UNDYED	36	Edgellant™ needle, Surgalloy™ alloy	SG-5637	
	3-0	2	30		UNDYED	12	Edgellant™ needle, Surgalloy™ alloy	SG-5163G	
P-21 1/2 CIRCLE 9mm 	6-0	0.7	18		UNDYED	12	Edgellant™ needle, Surgalloy™ alloy	SG-1816G	

Surgipro™ II and Surgipro™ 7-0, 8-0; Sofsilik™ 8-0; Polysorb™, Biosyn™, Monosof™, Maxon™, Velosorb™ Fast sutures differ from USP and EP only in diameter. Please refer to IFU for more details.

© 2018 Medtronic. All rights reserved. Medtronic, Medtronic logo and Further, Together are trademarks of Medtronic.







™*Third party brands are trademarks of their respective owners.

All other brands are trademarks of a Medtronic company.

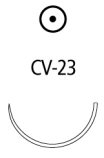
11/2018 US170542

CHROMIC GUT

Absorbable sutures composed of purified connective tissue derived from the serosal layer of bovine intestines

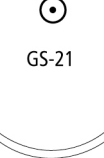
TAPER POINT									
Description		USP Size	EP Size	Length (in)	Length (cm)	Color	Units per box	Comments	Reorder code
CV-23 1/2 CIRCLE 17mm		5-0	1	30	75	UNDYED	36		UG-202
		4-0	1.5	30	75	UNDYED	36		UG-203
		3-0	2	30	75	UNDYED	36		UG-204
CV-24 1/2 CIRCLE 20mm		3-0	2	30	75	UNDYED	36		GG-185
CV-25 1/2 CIRCLE 22mm		4-0	1.5	30	75	UNDYED	36		GG-181
		3-0	2	30	75	UNDYED	36		GG-182
V-20 1/2 CIRCLE 26mm		4-0	1.5	30	75	UNDYED	36		GG-121
		3-0	2	30	75	UNDYED	36		GG-122
		2-0	3	30	75	UNDYED	36		GG-123
		0	3.5	30	75	UNDYED	36		GG-124
		1	4	30	75	UNDYED	36		GG-125
V-20 - V-20 1/2 CIRCLE 26mm (Double armed)		3-0	3	36	90	UNDYED	36		GG-522
GS-22 1/2 CIRCLE 27mm		2-0	3	30	75	UNDYED	36		CG-883
		0	3.5	30	75	UNDYED	36		CG-884
		1	4	30	75	UNDYED	36		CG-885
GS-21 1/2 CIRCLE 37mm		3-0	2	36	90	UNDYED	36		CG-922
		2-0	3	30	75	UNDYED	36		CG-811
		2-0	3	36	90	UNDYED	36		CG-923
		0	3.5	18	45	UNDYED	24	5 strands, D-Tach™	CG-10M
		0	3.5	30	75	UNDYED	36		CG-812
		0	3.5	36	90	UNDYED	36		CG-924
		1	4	30	75	UNDYED	36		CG-813
		1	4	36	90	UNDYED	36		CG-925

Surgipro™ II and Surgipro™ 7-0, 8-0; Sofsilik™ 8-0; Polysorb™, Biosyn™, Monosof™, Maxon™, Velosorb™ Fast sutures differ from USP and EP only in diameter. Please refer to IFU for more details.

© 2018 Medtronic. All rights reserved. Medtronic, Medtronic logo and Further, Together are trademarks of Medtronic.





™*Third party brands are trademarks of their respective owners.

All other brands are trademarks of a Medtronic company.

11/2018 US170542

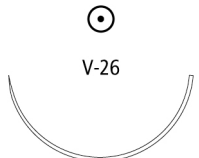
CHROMIC GUT

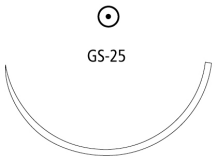
Absorbable sutures composed of purified connective tissue derived from the serosal layer of bovine intestines

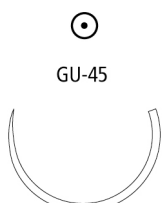
TAPER POINT								
Description	USP Size	EP Size	Length (in)	Length (cm)	Color	Units per box	Comments	Reorder code
V-26 1/2 CIRCLE 37mm 	3-0	2	30	75	UNDYED	36		GG-126
	2-0	3	30	75	UNDYED	36		GG-127
	0	3.5	30	75	UNDYED	36		GG-128
	1	4	30	75	UNDYED	36		GG-129
GS-24 1/2 CIRCLE 40mm 	3-0	2	36	90	UNDYED	36		CG-912
	2-0	3	36	90	UNDYED	36		CG-913
	0	3.5	30	75	UNDYED	36		CG-802
	0	3.5	36	90	UNDYED	36		CG-914
	1	4	30	75	UNDYED	36		CG-803
	1	4	36	90	UNDYED	36		CG-915
GS-25 1/2 CIRCLE 48mm (Not to scale) 	0	3.5	36	90	UNDYED	36		CG-904
	2	5	30	75	UNDYED	36		CG-866
	1	4	36	90	UNDYED	36		CG-905
GS-26 LOOP 1/2 CIRCLE 65mm (Not to scale) 	2	5	60	150	UNDYED	24	Loop	CG-825L
GU-46 5/8 CIRCLE 27mm 	3-0	2	30	75	UNDYED	36		UG-777
	2-0	3	30	75	UNDYED	36		UG-778
	0	3.5	30	75	UNDYED	36		UG-789
GU-45 5/8 CIRCLE 37mm 	2-0	3	30	75	UNDYED	36		UG-245
	0	3.5	30	75	UNDYED	36		UG-246

Surgipro™ II and Surgipro™ 7-0, 8-0; Sofsilik™ 8-0; Polysorb™, Biosyn™, Monosof™, Maxon™, Velosorb™ Fast sutures differ from USP and EP only in diameter. Please refer to IFU for more details.

© 2018 Medtronic. All rights reserved. Medtronic, Medtronic logo and Further, Together are trademarks of Medtronic.



™*Third party brands are trademarks of their respective owners.

All other brands are trademarks of a Medtronic company.

11/2018 US170542

CHROMIC GUT

Absorbable sutures composed of purified connective tissue derived from the serosal layer of bovine intestines

HEAVY TAPER POINT									
Description	USP Size	EP Size	Length (in)	Length (cm)	Color	Units per box	Comments	Reorder code	
HGS-20 1/2 CIRCLE 34mm  HGS-20	1	4	18	45	UNDYED	24	5 strands, D-Tach™	CG-975-M	
HGS-21 1/2 CIRCLE 37mm  HGS-21	1	4	18	45	UNDYED	24	5 strands, D-Tach™	CG-101M	
	1	5	30	75	UNDYED	12	5 strands, D-Tach™	CG-38M	
HGS-24 1/2 CIRCLE 40mm  HGS-24	1	4	30	75	UNDYED	36		CG-933	

TAPERCUTTING									
Description	USP Size	EP Size	Length (in)	Length (cm)	Color	Units per box	Comments	Reorder code	
KV-34 1/2 CIRCLE 37mm  KV-34	2-0	3	36	90	UNDYED	36		CG-963	
	0	3.5	36	90	UNDYED	36		CG-964	

BLUNT TAPER POINT									
Description	USP Size	EP Size	Length (in)	Length (cm)	Color	Units per box	Comments	Reorder code	
BGS-28 1/2 CIRCLE 85mm (Not to scale)  BGS-28	1	4	36	90	UNDYED	24	Protect Point™	CG49	

Surgipro™ II and Surgipro™ 7-0, 8-0; Sofsilik™ 8-0; Polysorb™, Biosyn™, Monosof™, Maxon™, Velosorb™ Fast sutures differ from USP and EP only in diameter. Please refer to IFU for more details.

© 2018 Medtronic. All rights reserved. Medtronic, Medtronic logo and Further, Together are trademarks of Medtronic.

™*Third party brands are trademarks of their respective owners.





All other brands are trademarks of a Medtronic company.

11/2018 US170542

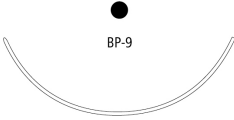
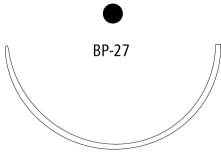
CHROMIC GUT

Absorbable sutures composed of purified connective tissue derived from the serosal layer of bovine intestines

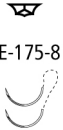
BLUNT POINT									
Description	USP Size	EP Size	Length (in)	Length (cm)	Color	Units per box	Comments	Reorder code	
BP-9 3/8 CIRCLE 64mm (Not to scale)		2-0	3	36	90	UNDYED	12	Protect Point™	CG-36
BP-27 1/2 CIRCLE 64mm (Not to scale)		0	3.5	30	75	UNDYED	24	Protect Point™	CG-47
		1	4	30	75	UNDYED	24	Protect Point™	CG-48

PREMIUM SPATULA									
Description	USP Size	EP Size	Length (in)	Length (cm)	Color	Units per box	Comments	Reorder code	
SS-14 - SS-14 1/4 CIRCLE 8.6mm (Double armed)		6-0	0.7	18	45	UNDYED	12	Surgalloy™	G-1791K
		5-0	1	12	30	UNDYED	12	Surgalloy™	G-1766-K
SE-140-8 - SE-140-8 3/8 CIRCLE 6.3mm (Double armed)		7-0	0.5	18	45	UNDYED	12	Surgalloy™	G-2797K
SE-175-8 - SE-175-8 1/2 CIRCLE 6.9mm (Double armed)		7-0	0.5	18	45	UNDYED	12	Surgalloy™	G-2745K
SS-2 - SS-2 1/2 CIRCLE 8.6mm (Double armed)		4-0	1.5	18	45	UNDYED	12		G-1798K

Surgipro™ II and Surgipro™ 7-0, 8-0; Sofsilik™ 8-0; Polysorb™, Biosyn™, Monosof™, Maxon™, Velosorb™ Fast sutures differ from USP and EP only in diameter. Please refer to IFU for more details.

© 2018 Medtronic. All rights reserved. Medtronic, Medtronic logo and Further, Together are trademarks of Medtronic.

™*Third party brands are trademarks of their respective owners.

All other brands are trademarks of a Medtronic company.

11/2018 US170542

CHROMIC GUT

Absorbable sutures composed of purified connective tissue derived from the serosal layer of bovine intestines

Reorder Code	Page	Reorder Code	Page	Reorder Code	Page
CG-101M	101	G-14	95	SG-5163G	98
CG-10M	99	G-15	95	SG-535	96
CG-36	102	G-1744	97	SG-5637	98
CG-38M	101	G-1752GK	96	SG-5637G	98
CG-415	97	G-1758K	97	SG-5644	98
CG-47	102	G-1766-K	102	SG-5644G	98
CG-48	102	G-1780K	96	SG-5687	98
CG49	101	G-1790K	96	SG-5687G	98
CG-802	100	G-1791K	102	SG-634	96
CG-803	100	G-1792K	96	SG-635	96
CG-811	99	G-1793K	96	SG-636	96
CG-812	99	G-1794K	96	SG-637	96
CG-813	99	G-1798K	102	SG-675	96
CG-815	97	G-216	95	SG-676	96
CG-816	97	G-253	95	UG-202	99
CG-817	97	G-254	95	UG-203	99
CG-825L	100	G-2745K	102	UG-204	99
CG-866	100	G-2797K	102	UG-245	100
CG-883	99	G-82	95	UG-246	100
CG-884	99	GG-121	99	UG-777	100
CG-885	99	GG-122	99	UG-778	100
CG-904	100	GG-123	99	UG-789	100
CG-905	100	GG-124	99		
CG-912	100	GG-125	99		
CG-913	100	GG-126	100		
CG-914	100	GG-127	100		
CG-915	100	GG-128	100		
CG-922	99	GG-129	100		
CG-923	99	GG-181	99		
CG-924	99	GG-182	99		
CG-925	99	GG-185	99		
CG-933	101	GG-522	99		
CG-963	101	LG-111	95		
CG-964	101	LG-112	95		
CG-975-M	101	LG-113	95		
CG-977	97	LG-114	95		
CG-982	97	LG-115	95		
CG-983	97	SG-1816G	98		
G-13	95	SG-197	96		

Surgipro™ II and Surgipro™ 7-0, 8-0; Sofsilik™ 8-0; Polysorb™, Biosyn™, Monosof™, Maxon™, Velosorb™ Fast sutures differ from USP and EP only in diameter. Please refer to IFU for more details.

© 2018 Medtronic. All rights reserved. Medtronic, Medtronic logo and Further, Together are trademarks of Medtronic.

™*Third party brands are trademarks of their respective owners.

All other brands are trademarks of a Medtronic company.

11/2018 US170542





MILD CHROMIC GUT

Absorbable sutures composed of purified connective tissue derived from the serosal layer of bovine intestines

Description	Plain, Chromic and Mild Chromic Gut Absorbable Sutures are absorbable sterile surgical sutures composed of purified connective tissue (mostly collagen) derived from the serosal layer of beef (bovine) intestines. They are packaged in a solution of 89% isopropanol, 10% water and 1% triethanolamine. Chromic gut is treated with chromic salt solution.
Indications	Plain, Chromic and Mild Chromic Gut Absorbable Sutures are indicated for use in general soft tissue approximation and/or ligation, including use in ophthalmic surgery, but not for use in cardiovascular or neurological surgery.
Actions	When Plain, Chromic and Mild Chromic Gut Absorbable Sutures are placed in tissue, a moderate tissue inflammation occurs characteristic of foreign body response to a substance.
Tensile Strength	Gradual loss of tensile strength and suture mass, as the enzymatic process dissolves the surgical gut until it is completely absorbed.
Sterilization	Gamma irradiation
Absorption	Many variable factors may affect the rate of absorption. Some of the major factors which may affect tensile strength loss and absorption rates are: 1. Type of Suture - Plain gut is expected to absorb more rapidly than chromic gut. 2. Infection - Surgical gut is absorbed faster in infected tissue than in noninfected tissue. 3. Tissue Sites - Surgical gut will absorb more rapidly in tissue where increased levels of enzymes are present, as in secretions exhibited in the stomach, cervix and vagina.
Packaging	Plain, Chromic and Mild Chromic Gut Absorbable Sutures are available in sizes 2 (6 Metric) through 7-0 (0.7 Metric) in chromic gut and in sizes 2 (6 Metric) through 6-0 (1 Metric) in plain gut. The sutures are supplied sterile, in pre-cut lengths and ligating reels, non-needled or affixed to various needle types using both permanent and removable needle attachment techniques. The sutures are available in box quantities of one, two and three dozen.

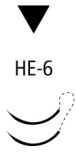
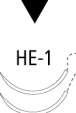
MILD CHROMIC GUT

Absorbable sutures composed of purified connective tissue derived from the serosal layer of bovine intestines

REVERSE CUTTING									
Description	USP Size	EP Size	Length (in)	Length (cm)	Color	Units per box	Comments	Reorder code	
HE-6 - HE-6 3/8 CIRCLE 7.4mm (Double armed) 	6-0	1	12	30	UNDYED	12	Surgalloy™	G-3794K	
HE-1 - HE-1 3/8 CIRCLE 11mm (Double armed) 	6-0	0.7	18	45	UNDYED	12	Surgalloy™	G-3790K	
	5-0	1	18	45	UNDYED	12	Surgalloy™	G-3791K	
C-1 3/8 CIRCLE 12mm 	6-0	0.7	18	45	UNDYED	12		G-3810	
C-1 - C-1 3/8 CIRCLE 12mm (Double armed) 	5-0	1	18	45	UNDYED	12		G-3711	
	4-0	1.5	18		UNDYED	12	Reliapoint™needle	G-3712	
HE-7 - HE-7 1/2 CIRCLE 7.4mm (Double armed) 	6-0	1	18	45	UNDYED	12	Surgalloy™	G-3756K	

Surgipro™ II and Surgipro™ 7-0, 8-0; Sofsilik™ 8-0; Polysorb™, Biosyn™, Monosof™, Maxon™, Velosorb™ Fast sutures differ from USP and EP only in diameter. Please refer to IFU for more details.

© 2018 Medtronic. All rights reserved. Medtronic, Medtronic logo and Further, Together are trademarks of Medtronic.

™*Third party brands are trademarks of their respective owners.

All other brands are trademarks of a Medtronic company.

11/2018 US170542

MILD CHROMIC GUT

Absorbable sutures composed of purified connective tissue derived from the serosal layer of bovine intestines

Reorder Code	Page	Reorder Code	Page	Reorder Code	Page
G-3711	107				
G-3712	107				
G-3756K	107				
G-3790K	107				
G-3791K	107				
G-3794K	107				
G-3810	107				

PLAIN GUT

Absorbable sutures composed of purified connective tissue derived from the serosal layer of bovine intestines

Description	Plain, Chromic and Mild Chromic Gut Absorbable Sutures are absorbable sterile surgical sutures composed of purified connective tissue (mostly collagen) derived from the serosal layer of beef (bovine) intestines. They are packaged in a solution of 89% isopropanol, 10% water and 1% triethanolamine. Chromic gut is treated with chromic salt solution.
Indications	Plain, Chromic and Mild Chromic Gut Absorbable Sutures are indicated for use in general soft tissue approximation and/or ligation, including use in ophthalmic surgery, but not for use in cardiovascular or neurological surgery.
Actions	When Plain, Chromic and Mild Chromic Gut Absorbable Sutures are placed in tissue, a moderate tissue inflammation occurs characteristic of foreign body response to a substance.
Tensile Strength	Gradual loss of tensile strength and suture mass, as the enzymatic process dissolves the surgical gut until it is completely absorbed.
Sterilization	Gamma irradiation
Absorption	Many variable factors may affect the rate of absorption. Some of the major factors which may affect tensile strength loss and absorption rates are: 1. Type of Suture - Plain gut is expected to absorb more rapidly than chromic gut. 2. Infection - Surgical gut is absorbed faster in infected tissue than in noninfected tissue. 3. Tissue Sites - Surgical gut will absorb more rapidly in tissue where increased levels of enzymes are present, as in secretions exhibited in the stomach, cervix and vagina.
Packaging	Plain, Chromic and Mild Chromic Gut Absorbable Sutures are available in sizes 2 (6 Metric) through 7-0 (0.7 Metric) in chromic gut and in sizes 2 (6 Metric) through 6-0 (1 Metric) in plain gut. The sutures are supplied sterile, in pre-cut lengths and ligating reels, non-needled or affixed to various needle types using both permanent and removable needle attachment techniques. The sutures are available in box quantities of one, two and three dozen.

PLAIN GUT

Absorbable sutures composed of purified connective tissue derived from the serosal layer of bovine intestines

NON NEEDED - PRE-CUT									
Description	USP Size	EP Size	Length (in)	Length (cm)	Color	Units per box	Comments	Reorder code	
PRE-CUT	2-0	3	18	45	UNDYED	24	12 strands	G-3	

NON NEEDED - STANDARD LENGTH									
Description	USP Size	EP Size	Length (in)	Length (cm)	Color	Units per box	Comments	Reorder code	
STANDARD LENGTH	1	4	60	150	UNDYED	24	Standard Length	G-205	

NON NEEDED - REEL									
Description	USP Size	EP Size	Length (in)	Length (cm)	Color	Units per box	Comments	Reorder code	
REEL	4-0	1.5	60	150	UNDYED	24		LG-101	
	3-0	2	60	150	UNDYED	24		LG-102	
	2-0	3	60	150	UNDYED	24		LG-103	
	0	3.5	60	150	UNDYED	24		LG-104	

Surgipro™ II and Surgipro™ 7-0, 8-0; Sofsilik™ 8-0; Polysorb™, Biosyn™, Monosof™, Maxon™, Velosorb™ Fast sutures differ from USP and EP only in diameter. Please refer to IFU for more details.

© 2018 Medtronic. All rights reserved. Medtronic, Medtronic logo and Further, Together are trademarks of Medtronic.







™*Third party brands are trademarks of their respective owners.

All other brands are trademarks of a Medtronic company.

11/2018 US170542

PLAIN GUT

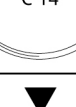
Absorbable sutures composed of purified connective tissue derived from the serosal layer of bovine intestines

REVERSE CUTTING									
Description	USP Size	EP Size	Length (in)	Length (cm)	Color	Units per box	Comments	Reorder code	
HE-1 3/8 CIRCLE 11mm	6-0	0.7	18	45	UNDYED	12	Surgalloy™	G-1774-K	
HE-1 - HE-1 3/8 CIRCLE 11mm (Double armed)	6-0	0.7	18	45	UNDYED	12	Surgalloy™	G-1770-K	
C-1 3/8 CIRCLE 12mm	5-0	1	18	45	UNDYED	36		CG-172	
HE-3 - HE-3 3/8 CIRCLE 13mm (Double armed)	5-0	1	18	45	UNDYED	12	Surgalloy™	G-1772-K	
	4-0	1.5	18	45	UNDYED	12	Surgalloy™	G-1773-K	
C-13 3/8 CIRCLE 19mm	5-0	1	18	45	UNDYED	36		SG-751	
	5-0	1	30	75	UNDYED	36	Reliapoint™needle	SG-820	
	4-0	1.5	18	45	UNDYED	36	Reliapoint™needle	SG-752	
	4-0	1.5	30	75	UNDYED	36	Reliapoint™needle	SG-821	
	3-0	2	30	75	UNDYED	36	Reliapoint™needle	SG-822	
C-14 3/8 CIRCLE 24mm	3-0	2	30	75	UNDYED	36	Reliapoint™needle	SG-810	
	2-0	3	30	75	UNDYED	36	Reliapoint™needle	SG-823	
C-23 1/2 CIRCLE 24mm	3-0	2	18		UNDYED	12	Reliapoint™needle	SG-612G	

Surgipro™ II and Surgipro™ 7-0, 8-0; Sofsilik™ 8-0; Polysorb™, Biosyn™, Monosof™, Maxon™, Velosorb™ Fast sutures differ from USP and EP only in diameter. Please refer to IFU for more details.

© 2018 Medtronic. All rights reserved. Medtronic, Medtronic logo and Further, Together are trademarks of Medtronic.



™*Third party brands are trademarks of their respective owners.

All other brands are trademarks of a Medtronic company.

11/2018 US170542

PLAIN GUT

Absorbable sutures composed of purified connective tissue derived from the serosal layer of bovine intestines

PREMIUM REVERSE CUTTING									
Description		USP Size	EP Size	Length (in)	Length (cm)	Color	Units per box	Comments	Reorder code
P-10 - P-10 3/8 CIRCLE 11mm (Double armed)		6-0	0.7	18	45	UNDYED	36	Surgalloy™	SG-1645
P-13 3/8 CIRCLE 13mm		5-0	1	18	45	UNDYED	12	Surgalloy™	SG-5686
		5-0	1	30	75	UNDYED	12	Surgalloy™	SG-5696
		4-0	1.5	18	45	UNDYED	36	Edgellant™ needle, Surgalloy™ alloy	SG-5654
P-12 3/8 CIRCLE 19mm		4-0	1.5	18	45	UNDYED	36	Surgalloy™	SG-5627
		3-0	2	18	45	UNDYED	36	Surgalloy™	SG-5630

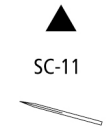
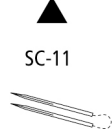
CONVENTIONAL CUTTING									
Description		USP Size	EP Size	Length (in)	Length (cm)	Color	Units per box	Comments	Reorder code
SC-11 STRAIGHT 12mm		4-0	1.5	18	45	UNDYED	36	Surgalloy™, Sulzle needle	SG604-2
SC-11 - SC-11 STRAIGHT 12mm (Double armed)		4-0	1.5	18	45	UNDYED	36	Surgalloy™, Sulzle needle	SG828-2

Surgipro™ II and Surgipro™ 7-0, 8-0; Sofsilik™ 8-0; Polysorb™, Biosyn™, Monosof™, Maxon™, Velosorb™ Fast sutures differ from USP and EP only in diameter. Please refer to IFU for more details.

© 2018 Medtronic. All rights reserved. Medtronic, Medtronic logo and Further, Together are trademarks of Medtronic.







™*Third party brands are trademarks of their respective owners.

All other brands are trademarks of a Medtronic company.

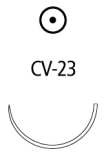
11/2018 US170542

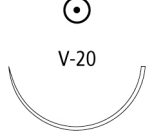
PLAIN GUT

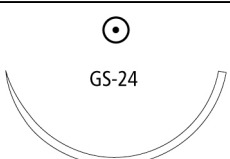
Absorbable sutures composed of purified connective tissue derived from the serosal layer of bovine intestines

TAPER POINT									
Description		USP Size	EP Size	Length (in)	Length (cm)	Color	Units per box	Comments	Reorder code
CV-23 1/2 CIRCLE 17mm		4-0	1.5	30	75	UNDYED	36		UG-207
GS-23 1/2 CIRCLE 22mm		3-0	2	30	75	UNDYED	36		UG-862
		2-0	3	30	75	UNDYED	36		UG-863
V-20 1/2 CIRCLE 26mm		4-0	1.5	30	75	UNDYED	36		GG-321
		3-0	2	30	75	UNDYED	36		GG-322
		2-0	3	30	75	UNDYED	36		GG-323
GS-21 1/2 CIRCLE 37mm		3-0	2	30	75	UNDYED	36		CG-842
		2-0	3	30	75	UNDYED	36		CG-843
		0	3.5	30	75	UNDYED	36		CG-844
		1	4	30	75	UNDYED	36		CG-845
V-26 1/2 CIRCLE 37mm		2-0	3	30	75	UNDYED	36		GG-133
GS-24 1/2 CIRCLE 40mm		3-0	2	30	75	UNDYED	36		CG-852
		2-0	3	30	75	UNDYED	36		CG853
		0	3.5	30	75	UNDYED	36		CG-854
		1	4	30	75	UNDYED	36		CG-855
GS-25 1/2 CIRCLE 48mm (Not to scale)		2-0	3	30	75	UNDYED	36		CG-872
GS-26 1/2 CIRCLE 65mm (Not to scale)		3-0	2	30	75	UNDYED	24		CG-62
		2-0	3	30	75	UNDYED	24		CG-63

Surgipro™ II and Surgipro™ 7-0, 8-0; Sofsilik™ 8-0; Polysorb™, Biosyn™, Monosof™, Maxon™, Velosorb™ Fast sutures differ from USP and EP only in diameter. Please refer to IFU for more details.

© 2018 Medtronic. All rights reserved. Medtronic, Medtronic logo and Further, Together are trademarks of Medtronic.

™*Third party brands are trademarks of their respective owners.

All other brands are trademarks of a Medtronic company.

11/2018 US170542

PLAIN GUT

Absorbable sutures composed of purified connective tissue derived from the serosal layer of bovine intestines

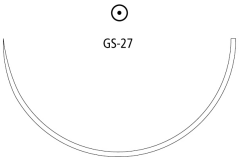
TAPER POINT									
Description	USP Size	EP Size	Length (in)	Length (cm)	Color	Units per box	Comments	Reorder code	
GS-27 1/2 CIRCLE 76mm (Not to scale)	2-0	3	30	75	UNDYED	24		CG-53	

PREMIUM SPATULA									
Description	USP Size	EP Size	Length (in)	Length (cm)	Color	Units per box	Comments	Reorder code	
SE-140-8 - SE-140-8 3/8 CIRCLE 6.3mm (Double armed)	6-0	0.7	18	45	UNDYED	12	Surgalloy™	G-1735-K	

Surgipro™ II and Surgipro™ 7-0, 8-0; Sofsilik™ 8-0; Polysorb™, Biosyn™, Monosof™, Maxon™, Velosorb™ Fast sutures differ from USP and EP only in diameter. Please refer to IFU for more details.

© 2018 Medtronic. All rights reserved. Medtronic, Medtronic logo and Further, Together are trademarks of Medtronic.

™*Third party brands are trademarks of their respective owners.

All other brands are trademarks of a Medtronic company.

11/2018 US170542

PLAIN GUT

Absorbable sutures composed of purified connective tissue derived from the serosal layer of bovine intestines

Reorder Code	Page	Reorder Code	Page	Reorder Code	Page
<u>CG-172</u>	<u>112</u>	<u>SG-820</u>	<u>112</u>		
<u>CG-53</u>	<u>115</u>	<u>SG-821</u>	<u>112</u>		
<u>CG-62</u>	<u>114</u>	<u>SG-822</u>	<u>112</u>		
<u>CG-63</u>	<u>114</u>	<u>SG-823</u>	<u>112</u>		
<u>CG-842</u>	<u>114</u>	<u>SG828-2</u>	<u>113</u>		
<u>CG-843</u>	<u>114</u>	<u>UG-207</u>	<u>114</u>		
<u>CG-844</u>	<u>114</u>	<u>UG-862</u>	<u>114</u>		
<u>CG-845</u>	<u>114</u>	<u>UG-863</u>	<u>114</u>		
<u>CG-852</u>	<u>114</u>				
<u>CG853</u>	<u>114</u>				
<u>CG-854</u>	<u>114</u>				
<u>CG-855</u>	<u>114</u>				
<u>CG-872</u>	<u>114</u>				
<u>G-1735-K</u>	<u>115</u>				
<u>G-1770-K</u>	<u>112</u>				
<u>G-1772-K</u>	<u>112</u>				
<u>G-1773-K</u>	<u>112</u>				
<u>G-1774-K</u>	<u>112</u>				
<u>G-205</u>	<u>111</u>				
<u>G-3</u>	<u>111</u>				
<u>GG-133</u>	<u>114</u>				
<u>GG-321</u>	<u>114</u>				
<u>GG-322</u>	<u>114</u>				
<u>GG-323</u>	<u>114</u>				
<u>LG-101</u>	<u>111</u>				
<u>LG-102</u>	<u>111</u>				
<u>LG-103</u>	<u>111</u>				
<u>LG-104</u>	<u>111</u>				
<u>SG-1645</u>	<u>113</u>				
<u>SG-5627</u>	<u>113</u>				
<u>SG-5630</u>	<u>113</u>				
<u>SG-5654</u>	<u>113</u>				
<u>SG-5686</u>	<u>113</u>				
<u>SG-5696</u>	<u>113</u>				
<u>SG604-2</u>	<u>113</u>				
<u>SG-612G</u>	<u>112</u>				
<u>SG-751</u>	<u>112</u>				
<u>SG-752</u>	<u>112</u>				
<u>SG-810</u>	<u>112</u>				

Surgipro™ II and Surgipro™ 7-0, 8-0; Sofsilik™ 8-0; Polysorb™, Biosyn™, Monosof™, Maxon™, Velosorb™ Fast sutures differ from USP and EP only in diameter. Please refer to IFU for more details.

© 2018 Medtronic. All rights reserved. Medtronic, Medtronic logo and Further, Together are trademarks of Medtronic.

™*Third party brands are trademarks of their respective owners.

All other brands are trademarks of a Medtronic company.

11/2018 US170542





SURGIPRO™/SURGIPRO II™

Monofilament Polypropylene Non-Absorbable Sutures

Description	Surgipro™ and Surgipro™ II monofilament sutures (clear or pigmented) are inert, nonabsorbable, sterile sutures composed of an isotactic crystalline stereoisomer of polypropylene (a synthetic linear polyolefin) and polyethylene.
Indications	Surgipro™ and Surgipro™ II polypropylene sutures are indicated for use in general soft tissue approximation and/or ligation, including use in cardiovascular, ophthalmic, and neural tissue.
Actions	Surgipro™ and Surgipro™ II polypropylene sutures elicit a minimal acute inflammatory reaction in tissues, which is followed by gradual encapsulation of the suture by fibrous connective tissue.
Tensile Strength	Surgipro™ and Surgipro™ II polypropylene sutures are not absorbed, nor is any significant change in strength retention known to occur in vivo.
Sterilization	Ethylene oxide.
Packaging	Surgipro™ and Surgipro™ II polypropylene sutures are available either undyed (clear) or dyed with Copper Phthalocyanine Blue. Surgipro™ sutures are available in sizes 1 (4 Metric), through 6-0 (0.7 Metric). Surgipro™ II sutures are available in sizes 3-0 (2 Metric) through 8-0 (0.4 Metric). The sutures are supplied sterile; affixed to various types of needles, using both permanent needle attachment techniques. Surgipro™ and Surgipro™ II polypropylene sutures are also available with PTFE (polytetrafluorethylene) Pledgets for use as a pad between the suture area and the tissue surface to increase the load bearing area. Surgipro™ polypropylene sutures are available in presentations containing Bead and Collar components to anchor the ends of the suture for subcuticular closure or for use as tendon sutures.

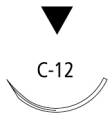
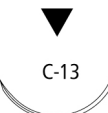
SURGIPRO™/SURGIPRO II™

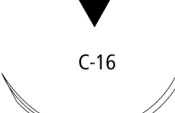
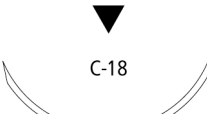
Monofilament Polypropylene Non-Absorbable Sutures

REVERSE CUTTING									
Description	USP Size	EP Size	Length (in)	Length (cm)	Color	Units per box	Comments	Reorder code	
C-12 3/8 CIRCLE 16mm 	6-0	0.7	18	45	BLUE	36	Reliapoint™needle	SP-660	
	6-0	0.7	18	45	BLUE	12	Reliapoint™needle	SP-660G	
	5-0	1	18	45	BLUE	12	Reliapoint™needle	SP-559G	
	4-0	1.5	30	75	BLUE	36	Reliapoint™needle	SP-631	
C-13 3/8 CIRCLE 19mm 	5-0	1	18	45	BLUE	36	Reliapoint™needle	SP-661	
	5-0	1	18	45	BLUE	12	Reliapoint™needle	SP-661G	
	4-0	1.5	18	45	BLUE	12	Reliapoint™needle	SP-683G	
	4-0	1.5	18	45	BLUE	36	Reliapoint™needle	SP-683	
	3-0	2	18	45	BLUE	36	Reliapoint™needle	SP-665	
	3-0	2	18	45	BLUE	12	Reliapoint™needle	SP-665G	
	3-0	2	30	75	BLUE	36	Reliapoint™needle	SP-655	
C-14 3/8 CIRCLE 24mm 	4-0	1.5	18	45	BLUE	36	Reliapoint™needle	SP-629	
	3-0	2	18	45	BLUE	36	Reliapoint™needle	SP-684	
	3-0	2	18	45	BLUE	12	Reliapoint™needle	SP-684G	
C-15 3/8 CIRCLE 26mm 	2-0	3	18	45	BLUE	12	Reliapoint™needle	SP-868G	
	2-0	3	18	45	BLUE	36	Reliapoint™needle	SP-868	
	2-0	3	30	75	BLUE	36	Reliapoint™needle	SP-685	
C-16 3/8 CIRCLE 30mm 	4-0	1.5	30	75	BLUE	36	Reliapoint™needle	SP-670	
	3-0	2	30	75	BLUE	36	Reliapoint™needle	SP-675	
C-18 3/8 CIRCLE 35mm 	3-0	2	30	75	BLUE	12	2 beads & 2 collars, Reliapoint™needle	SP-624-BC	
C-17 3/8 CIRCLE 39mm 	3-0	2	30	75	BLUE	36	Reliapoint™needle	SP-649	
	2-0	3	30	75	BLUE	36	Reliapoint™needle	SP-689	
	0	3.5	30	75	BLUE	36	Reliapoint™needle	SP-690	
	0	3.5	30	75	BLUE	12		SP690G	
GS-18 3/8 CIRCLE 77mm (Not to scale) 	2	5	24	60	BLUE	12	3 strands	3-CP-360	

Surgipro™ II and Surgipro™ 7-0, 8-0; Sofsilik™ 8-0; Polysorb™, Biosyn™, Monosof™, Maxon™, Velosorb™ Fast sutures differ from USP and EP only in diameter. Please refer to IFU for more details.

© 2018 Medtronic. All rights reserved. Medtronic, Medtronic logo and Further, Together are trademarks of Medtronic.



™*Third party brands are trademarks of their respective owners.

All other brands are trademarks of a Medtronic company.

11/2018 US170542

SURGIPRO™/SURGIPRO II™

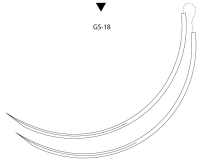
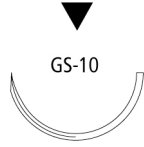
Monofilament Polypropylene Non-Absorbable Sutures

REVERSE CUTTING									
Description	USP Size	EP Size	Length (in)	Length (cm)	Color	Units per box	Comments	Reorder code	
GS-18 - GS-18 3/8 CIRCLE 77mm (Double armed) (Not to scale) 	2	5	30	75	BLUE	24		CP-460	
GS-10 1/2 CIRCLE 26mm 	2-0	3	30	75	BLUE	36		CP-443	
GS-11 1/2 CIRCLE 37mm 	2-0	3	30	75	BLUE	36		CP-453	

Surgipro™ II and Surgipro™ 7-0, 8-0; Sofsilik™ 8-0; Polysorb™, Biosyn™, Monosof™, Maxon™, Velosorb™ Fast sutures differ from USP and EP only in diameter. Please refer to IFU for more details.

© 2018 Medtronic. All rights reserved. Medtronic, Medtronic logo and Further, Together are trademarks of Medtronic.





™*Third party brands are trademarks of their respective owners.

All other brands are trademarks of a Medtronic company.

11/2018 US170542

SURGIPTM/SURGIPTM II

Monofilament Polypropylene Non-Absorbable Sutures

PREMIUM REVERSE CUTTING									
Description	USP Size	EP Size	Length (in)	Length (cm)	Color	Units per box	Comments	Reorder code	
P-16 3/8 CIRCLE 7mm 	7-0	0.5	18		BLUE	12	Edgellant™ needle, Surgalloy™ alloy	SP1647G	
P-10 3/8 CIRCLE 11mm 	7-0	0.5	18	45	BLUE	36	Edgellant™ needle, Surgalloy™ alloy	SP-1696	
	7-0	0.5	18	45	BLUE	12	Edgellant™ needle, Surgalloy™ alloy	SP-1696G	
	6-0	0.7	18	45	CLEAR	36	Edgellant™ needle, Surgalloy™ alloy	SP-1606	
	6-0	0.7	18	45	BLUE	36	Edgellant™ needle, Surgalloy™ alloy	SP-1697	
	6-0	0.7	18	45	BLUE	12	Edgellant™ needle, Surgalloy™ alloy	SP-5697G	
	5-0	1	18	45	BLUE	12	Edgellant™ needle, Surgalloy™ alloy	SP-2698G	
P-13 3/8 CIRCLE 13mm 	6-0	0.7	18	45	BLUE	12	Surgalloy™	SP-5695-G	
	6-0	0.7	18	45	BLUE	36	Edgellant™ needle, Surgalloy™ alloy	SP-5695	
	5-0	1	18	45	BLUE	36	Edgellant™ needle, Surgalloy™ alloy	SP-5698	
	5-0	1	18	45	BLUE	12	Surgalloy™	SP-5698-G	
	4-0	1.5	18	45	BLUE	36	Edgellant™ needle, Surgalloy™ alloy	SP-5699	
	4-0	1.5	18	45	BLUE	12	Edgellant™ needle, Surgalloy™ alloy	SP-5699G	
P-11 3/8 CIRCLE 16mm 	6-0	0.7	18	45	BLUE	12	Edgellant™ needle, Surgalloy™ alloy	SP-5680G	
	5-0	1	18	45	BLUE	12	Edgellant™ needle, Surgalloy™ alloy	SP-5681G	
	5-0	1	18	45	BLUE	36	Edgellant™ needle, Surgalloy™ alloy	SP-5681	
	4-0	1.5	18	45	BLUE	12	Edgellant™ needle, Surgalloy™ alloy	SP-5692G	
	3-0	2	18	45	BLUE	12	Edgellant™ needle, Surgalloy™ alloy	SP-1693G	
P-12 3/8 CIRCLE 19mm 	5-0	1	18	45	BLUE	12	Edgellant™ needle, Surgalloy™ alloy	SP-5686G	
	5-0	1	18	45	BLUE	36	Edgellant™ needle, Surgalloy™ alloy	SP-5686	
	4-0	1.5	18	45	BLUE	36	Edgellant™ needle, Surgalloy™ alloy	SP-5682	
	4-0	1.5	18	45	BLUE	12	Edgellant™ needle, Surgalloy™ alloy	SP-5682G	
	3-0	2	18	45	BLUE	12	Edgellant™ needle, Surgalloy™ alloy	SP-5687G	
	3-0	2	18	45	BLUE	36	Edgellant™ needle, Surgalloy™ alloy	SP-5687	
	3-0	2	30	75	BLUE	36	Edgellant™ needle, Surgalloy™ alloy	SP-5587	

Surgipro™ II and Surgipro™ 7-0, 8-0; Sofsilik™ 8-0; Polysorb™, Biosyn™, Monosof™, Maxon™, Velosorb™ Fast sutures differ from USP and EP only in diameter. Please refer to IFU for more details.

© 2018 Medtronic. All rights reserved. Medtronic, Medtronic logo and Further, Together are trademarks of Medtronic.

™*Third party brands are trademarks of their respective owners.

All other brands are trademarks of a Medtronic company.

11/2018 US170542

SURGIPTM/SURGIPTM II

Monofilament Polypropylene Non-Absorbable Sutures

PREMIUM REVERSE CUTTING									
Description	USP Size	EP Size	Length (in)	Length (cm)	Color	Units per box	Comments	Reorder code	
P-14 3/8 CIRCLE 24mm 	3-0	2	18	45	BLUE	36	Edgellant™ needle, Surgalloy™ alloy	SP-5663	
	3-0	2	18	45	BLUE	12	Edgellant™ needle, Surgalloy™ alloy	SP-5663G	
	3-0	2	30	75	BLUE	36	Edgellant™ needle, Surgalloy™ alloy	SP-5563	

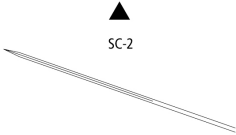
CONVENTIONAL CUTTING									
Description	USP Size	EP Size	Length (in)	Length (cm)	Color	Units per box	Comments	Reorder code	
SC-2 STRAIGHT 60mm (Not to scale) 	4-0	1.5	30	75	BLUE	36		SP-621	
	3-0	2	30	75	BLUE	24	2 beads & 2 collars	SP-622-BC	
	3-0	2	30	75	BLUE	36		SP-622	
	3-0	2	30	75	BLUE	12		SP622G	
	2-0	3	30	75	BLUE	24	2 beads & 2 collars	SP-623-BC	
	2-0	3	30	75	BLUE	36		SP-623	

Surgipro™ II and Surgipro™ 7-0, 8-0; Sofsilik™ 8-0; Polysorb™, Biosyn™, Monosof™, Maxon™, Velosorb™ Fast sutures differ from USP and EP only in diameter. Please refer to IFU for more details.

© 2018 Medtronic. All rights reserved. Medtronic, Medtronic logo and Further, Together are trademarks of Medtronic.











™*Third party brands are trademarks of their respective owners.

All other brands are trademarks of a Medtronic company.

11/2018 US170542

SURGIPTM/SURGIPTM II

Monofilament Polypropylene Non-Absorbable Sutures

TAPER POINT									
Description	USP Size	EP Size	Length (in)	Length (cm)	Color	Units per box	Comments	Reorder code	
MV-70-3 3/8 CIRCLE 4mm MV-70-3 	10-0	0.2	5	13	BLUE	12	Surgalloy™	P-2790G	
MV-100-4 - MV-100-4 3/8 CIRCLE 5mm (Double armed) MV-100-4 	10-0	0.2	2	5	BLUE			P-2795G	
MV-135-5 - MV-135-5 3/8 CIRCLE 6mm (Double armed) MV-135-5  	8-0	0.4	18	45	BLUE	12	2 strands, Surgalloy™	VP-900-MX	
	8-0	0.4	18	45	BLUE	12	5 strands, Surgalloy™	VP-901-MX	
	8-0	0.4	18	45	BLUE	36	Surgalloy™	VP-900-X	
	8-0	0.4	24	60	BLUE	36	Surgalloy™	VP-902-X	
	8-0	0.4	24	60	BLUE	12	2 strands, Surgalloy™	VP-902-MX	
	8-0	0.4	24	60	BLUE	12	5 strands, Surgalloy™	VP-903-MX	
	8-0	0.4	30	75	BLUE	12	Surgalloy™	VP-973-X	
	7-0	0.5	24	60	BLUE	36	Surgalloy™	VP-904-X	
MVF-135-5 - MVF-135-5 3/8 CIRCLE 6mm (Double armed) MVF-135-5  	8-0	0.4	24	60	BLUE	12	2 strands, Surgalloy™	VP-209MX	
CV-351 - CV-351 3/8 CIRCLE 8mm (Double armed) CV-351  	8-0	0.4	24	60	BLUE	36	Cardioint™	VP-738-X	
	8-0	0.4	24	60	BLUE	12	2 strands	VP-738-MX	
	7-0	0.5	24	60	BLUE	36	Cardioint™	VP-630-X	
	6-0	0.7	24	60	BLUE	36	Cardioint™	VP-631-X	
MV-175-8 - MV-175-8 3/8 CIRCLE 8mm (Double armed) MV-175-8  	8-0	0.4	18	45	BLUE	12	2 strands, Surgalloy™	VP-744-MX	
	8-0	0.4	18	45	BLUE	36	Surgalloy™	VP-744-X	
	8-0	0.4	24	60	BLUE	36	Surgalloy™	VP-745-X	
	8-0	0.4	24	60	BLUE	12	2 strands, Surgalloy™	VP-743-MX	
	8-0	0.4	30	75	BLUE	12	2 strands, Surgalloy™	VP-753-MX	
	7-0	0.5	18	45	BLUE	12	5 strands, Surgalloy™	VP-734-MX	
	7-0	0.5	18	45	BLUE	12	2 strands, Surgalloy™, Long Pack	VP-736-M	
	7-0	0.5	18	45	BLUE	36	Surgalloy™	VP-628	
	7-0	0.5	24	60	BLUE	12	2 strands, Surgalloy™	VP-737-MX	
	7-0	0.5	24	60	BLUE	12	5 strands, Surgalloy™	VP-735-MX	
	7-0	0.5	24	60	BLUE	36	Surgalloy™	VP-735-X	
	7-0	0.5	30	75	BLUE	36	Surgalloy™	VP-747-X	
	7-0	0.5	30	75	BLUE	12	2 strands, Surgalloy™	VP-747-MX	

Surgipro™ II and Surgipro™ 7-0, 8-0; Sofsil™ 8-0; Polysorb™, Biosyn™, Monosof™, Maxon™, Velosorb™ Fast sutures differ from USP and EP only in diameter. Please refer to IFU for more details.

© 2018 Medtronic. All rights reserved. Medtronic, Medtronic logo and Further, Together are trademarks of Medtronic.





™*Third party brands are trademarks of their respective owners.

All other brands are trademarks of a Medtronic company.

11/2018 US170542

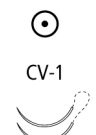
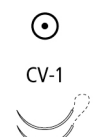
SURGIPTM/SURGIPTM II

Monofilament Polypropylene Non-Absorbable Sutures

TAPER POINT									
Description	USP Size	EP Size	Length (in)	Length (cm)	Color	Units per box	Comments	Reorder code	
MVF-175-8 - MVF-175-8 3/8 CIRCLE 8mm (Double armed)	 MVF-175-8	7-0	0.5	24	60	BLUE	36	Surgalloy™	VPF-735-X
CV-1 OPTIVIS - CV-1 OPTIVIS 3/8 CIRCLE 9mm (Double armed)	 CV-1	7-0	0.5	24	60	BLUE	12	5 strands, Optivis™	VP-72-MX
		7-0	0.5	24	60	BLUE	36	Optivis™	VP-72-X
		7-0	0.5	30	75	BLUE	12	5 strands, Optivis™	VP-37MX
		6-0	0.7	24	60	BLUE	36	Optivis™	VP-73-X
		6-0	0.7	24	60	BLUE	12	5 strands, Optivis™	VP-73-MX
CV-1 - CV-1 3/8 CIRCLE 9mm (Double armed)	 CV-1	7-0	0.5	18	45	BLUE	36	Surgalloy™	VP-701-X
		7-0	0.5	18	45	BLUE	12	5 strands, Surgalloy™	VP-701-MX
		7-0	0.5	24	60	BLUE	12	5 strands, Surgalloy™	VP-702-MX
		7-0	0.5	24	60	BLUE	36	Surgalloy™	VP-702-X
		7-0	0.5	30	75	BLUE	36	Surgalloy™	VP-713-X
		7-0	0.5	30	75	BLUE	12	5 strands, Surgalloy™	VP-713-MX
		6-0	0.7	18	45	BLUE	36	Surgalloy™	VP-746-X
		6-0	0.7	18	45	BLUE	12	2 strands, Surgalloy™	VP-746-MX
		6-0	0.7	24	60	BLUE	12	5 strands, Surgalloy™	VP-703-MX
		6-0	0.7	24	60	BLUE	36	Surgalloy™	VP-703-X
		6-0	0.7	30	75	BLUE	36	Surgalloy™	VP-709-X
		6-0	0.7	30	75	BLUE	12	5 strands, Surgalloy™	VP-709-MX
		6-0	0.7	36	90	BLUE	36	Surgalloy™	VP-365X
		CVF-1 - CVF-1 3/8 CIRCLE 9mm (Double armed)	 CVF-1	7-0	0.5	24	60	BLUE	12
7-0	0.5			24	60	BLUE	36	Surgalloy™	VPF-702-X
7-0	0.5			30	75	BLUE	36	Surgalloy™	VPF-713-X
6-0	0.7			24	60	BLUE	12	5 strands, Surgalloy™	VPF-703-MX
6-0	0.7			24	60	BLUE	36	Surgalloy™	VPF-703-X
MV-175-9 - MV-175-9 3/8 CIRCLE 10mm (Double armed)	 MV-175-9	8-0	0.4	24	60	BLUE	36	Surgalloy™	VPF-763-X
		8-0	0.4	24	60	BLUE	12	2 strands, Surgalloy™	VP763MX
		7-0	0.5	24	60	BLUE	12	5 strands, Surgalloy™	VP-759-MX
		7-0	0.5	30	75	BLUE	12	5 strands, Long Pack, Surgalloy™	VP-875-MX
		7-0	0.5	30	75	BLUE	36	Surgalloy™	VP-875-X
MVF-175-9 - MVF-175-9 3/8 CIRCLE 10mm (Double armed)	 MVF-175-9	7-0	0.5	24	60	BLUE	27	Surgalloy™	VP760MX

Surgipro™ II and Surgipro™ 7-0, 8-0; Sofsil™ 8-0; Polysorb™, Biosyn™, Monosof™, Maxon™, Velosorb™ Fast sutures differ from USP and EP only in diameter. Please refer to IFU for more details.

© 2018 Medtronic. All rights reserved. Medtronic, Medtronic logo and Further, Together are trademarks of Medtronic.











™*Third party brands are trademarks of their respective owners.

All other brands are trademarks of a Medtronic company.

11/2018 US170542

SURGIPTM/SURGIPTM II

Monofilament Polypropylene Non-Absorbable Sutures

TAPER POINT									
Description		USP Size	EP Size	Length (in)	Length (cm)	Color	Units per box	Comments	Reorder code
CV OPTIVIS - CV OPTIVIS 3/8 CIRCLE 11mm (Double armed)	 CV 	6-0	0.7	24	60	BLUE	36	Optivis™	VP-74-X
CV - CV 3/8 CIRCLE 11mm (Double armed)	 CV 	7-0	0.5	24	60	BLUE	12	5 strands, Long Pack, Surgalloy™	VP-765-MX
		6-0	0.7	30	75	BLUE	36	Surgalloy™	VP-776-X
		6-0	0.7	30	75	BLUE	36	Surgalloy™	VPF-776-X
CVF - CVF 3/8 CIRCLE 11mm (Double armed)	 CVF 	6-0	0.7	30	75	BLUE	36	Surgalloy™	VPF-776-X
CV-11 3/8 CIRCLE 13mm	 CV-11 	6-0	0.7	30	75	BLUE	36	Surgalloy™	VP-889-X
		5-0	1	30	75	BLUE	36	Surgalloy™	VP-890-X
		4-0	1.5	30	75	BLUE	36	Surgalloy™	VP-891
CV-11 OPTIVIS - CV-11 OPTIVIS 3/8 CIRCLE 13mm (Double armed)	 CV-11 	6-0	0.7	30	75	BLUE	12	5 strands, Optivis™	VP-76-MX
		6-0	0.7	30	75	BLUE	36	Optivis™	VP-76-X
		5-0	1	24	60	BLUE	36	Optivis™	VP-75-X
		5-0	1	36	90	BLUE	36	Optivis™	VP-70-X

Surgipro™ II and Surgipro™ 7-0, 8-0; Sofsil™ 8-0; Polysorb™, Biosyn™, Monosof™, Maxon™, Velosorb™ Fast sutures differ from USP and EP only in diameter. Please refer to IFU for more details.

© 2018 Medtronic. All rights reserved. Medtronic, Medtronic logo and Further, Together are trademarks of Medtronic.





™*Third party brands are trademarks of their respective owners.

All other brands are trademarks of a Medtronic company.

11/2018 US170542

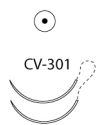
SURGIPTM/SURGIPTM II

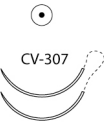
Monofilament Polypropylene Non-Absorbable Sutures

TAPER POINT									
Description		USP Size	EP Size	Length (in)	Length (cm)	Color	Units per box	Comments	Reorder code
CV-11 - CV-11 3/8 CIRCLE 13mm (Double armed)	 <p>CV-11</p>	7-0	0.5	18	45	BLUE	36	Surgalloy™	VP-800-X
		7-0	0.5	24	60	BLUE	36	Surgalloy™	VP-727-X
		7-0	0.5	30	75	BLUE	36	Surgalloy™	VP-812-X
		6-0	0.7	18	45	BLUE	36	Surgalloy™	VP-718-X
		6-0	0.7	18	45	BLUE	12	5 strands, Surgalloy™	VP-718-MX
		6-0	0.7	18	45	BLUE	36		VP-78-X
		6-0	0.7	24	60	BLUE	12	5 strands, Surgalloy™	VP-726-MX
		6-0	0.7	24	60	BLUE	36	Surgalloy™	VP-726-X
		6-0	0.7	30	75	BLUE	36	Surgalloy™	VP-706-X
		6-0	0.7	30	75	BLUE	12	5 strands, Surgalloy™	VP-706-MX
		6-0	0.7	36	90	BLUE	36	Surgalloy™	VP-363X
		5-0	1	18	45	BLUE	36	Surgalloy™	VP-719-X
		5-0	1	18	45	BLUE	12	5 strands, Surgalloy™	VP-719-MX
		5-0	1	24	60	BLUE	36	Surgalloy™	VP-725-X
		5-0	1	24	60	BLUE	12	5 strands, Surgalloy™	VP-725-MX
		5-0	1	30	75	BLUE	12	5 strands, Surgalloy™	VP-705-MX
		5-0	1	30	75	BLUE	12	2 strands, Surgalloy™	VP-897-M
		5-0	1	30	75	BLUE	36	Surgalloy™	VP-705-X
		5-0	1	36	90	BLUE	36	Surgalloy™	VP-720-X
		5-0	1	36	90	BLUE	12	5 strands, Surgalloy™	VP-720-MX
4-0	1.5	30	75	BLUE	36	Surgalloy™	VP-813-X		
CV-301 - CV-301 3/8 CIRCLE 13mm (Double armed)	 <p>CV-301</p>	6-0	0.7	30	75	BLUE	12		VP86X
CVF-11 - CVF-11 3/8 CIRCLE 13mm (Double armed)	 <p>CVF-11</p>	6-0	0.7	24	60	BLUE	36	Surgalloy™	VPF-726-X
		6-0	0.7	24	60	BLUE	12	5 strands, Surgalloy™	VP-126MX
		6-0	0.7	30	75	BLUE	36	Surgalloy™	VPF-706-X
		5-0	1	36	90	BLUE	36	Surgalloy™	VPF-720-X
		5-0	1	36	90	BLUE	12	5 strands, Surgalloy™	VP-120MX
CV-307 - CV-307 3/8 CIRCLE 16mm (Double armed)	 <p>CV-307</p>	4-0	1.5	36	90	BLUE	36		VP-681-X
CV-15 3/8 CIRCLE 17mm	 <p>CV-15</p>	4-0	1.5	30	75	BLUE	36	Surgalloy™	VP-881-X

Surgipro™ II and Surgipro™ 7-0, 8-0; Sofsil™ 8-0; Polysorb™, Biosyn™, Monosof™, Maxon™, Velosorb™ Fast sutures differ from USP and EP only in diameter. Please refer to IFU for more details.

© 2018 Medtronic. All rights reserved. Medtronic, Medtronic logo and Further, Together are trademarks of Medtronic.







™*Third party brands are trademarks of their respective owners.

All other brands are trademarks of a Medtronic company.

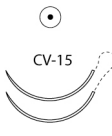
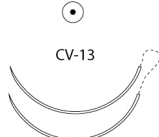
11/2018 US170542

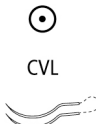
SURGIPTM/SURGIPTM II

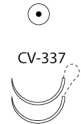
Monofilament Polypropylene Non-Absorbable Sutures

TAPER POINT									
Description	USP Size	EP Size	Length (in)	Length (cm)	Color	Units per box	Comments	Reorder code	
CV-15 - CV-15 3/8 CIRCLE 17mm (Double armed) 	5-0	1	30	75	BLUE	36	Surgalloy™	VP-570X	
	5-0	1	36	90	BLUE	36	Surgalloy™, Nupack™	VP-580-X	
	4-0	1.5	24	60	BLUE	36	Surgalloy™	VP-584-X	
	4-0	1.5	36	90	BLUE	36	Surgalloy™	VP-581-X	
	4-0	1.5	36	90	BLUE	36	Pledget 3x7mm FIRM, Surgalloy™	VP-582-X	
	4-0	1.5	48	120	BLUE	36	Surgalloy™	VP-583-X	
	3-0	2	36	90	BLUE	36	Surgalloy™	VP-585-X	
CV-13 - CV-13 3/8 CIRCLE 22mm (Double armed) 	4-0	1.5	30	75	BLUE	36	Surgalloy™	VP-841-X	
	4-0	1.5	36	90	BLUE	36	Surgalloy™	VP-851-X	
	3-0	2	36	90	BLUE	36	Surgalloy™	VP-532X	
	2-0	3	36	90	BLUE	36		VP-533	
CVL OPTIVIS - CVL OPTIVIS CARDIO CURVE 11mm (Double armed) 	7-0	0.5	24	60	BLUE	12	2 strands, Optivis™	VP-652-MX	
CVL - CVL CARDIO CURVE 11mm (Double armed) 	7-0	0.5	60	24	BLUE	12	4 strands	VP-653-MX	
CV-20 - CV-20 1/2 CIRCLE 10mm (Double armed) 	7-0	0.5	24	60	BLUE	36	Surgalloy™	VP-772-X	
	6-0	0.7	24	60	BLUE	36	Surgalloy™	VP-754-X	
	5-0	1	24	60	BLUE	36	Surgalloy™	VP-755-X	
CV-337 - CV-337 1/2 CIRCLE 10mm (Double armed) 	6-0	0.7	24	60	BLUE	36	Cardioint™	VP-854-X	
CVF-21 - CVF-21 1/2 CIRCLE 12mm (Double armed) 	4-0	1.5	24	60	BLUE	36	Surgalloy™	VPF-610-X	
CV-22 - CV-22 1/2 CIRCLE 13mm (Double armed) 	6-0	0.7	18	45	BLUE	36	Surgalloy™	VP-714-X	
	6-0	0.7	24	60	BLUE	36	Surgalloy™	VP-711-X	
	6-0	0.7	30	75	BLUE	36	Surgalloy™	VP-733-X	
	6-0	0.7	30	75	BLUE	12	5 strands, Surgalloy™	VP-733-MX	
	5-0	1	18	45	BLUE	36	Surgalloy™	VP-715-X	
	5-0	1	24	60	BLUE	36	Surgalloy™, Nupack™	VP-205-X	
	5-0	1	30	75	BLUE	12	5 strands, Surgalloy™	VP-710-MX	
	5-0	1	30	75	BLUE	36	Surgalloy™	VP-710-X	
	4-0	1.5	24	60	BLUE	36	Surgalloy™	VP-204-X	

Surgipro™ II and Surgipro™ 7-0, 8-0; Sofsil™ 8-0; Polysorb™, Biosyn™, Monosof™, Maxon™, Velosorb™ Fast sutures differ from USP and EP only in diameter. Please refer to IFU for more details.

© 2018 Medtronic. All rights reserved. Medtronic, Medtronic logo and Further, Together are trademarks of Medtronic.















™*Third party brands are trademarks of their respective owners.

All other brands are trademarks of a Medtronic company.

11/2018 US170542

SURGIPTM/SURGIPTM II

Monofilament Polypropylene Non-Absorbable Sutures

TAPER POINT									
Description		USP Size	EP Size	Length (in)	Length (cm)	Color	Units per box	Comments	Reorder code
CVF-22 - CVF-22 1/2 CIRCLE 13mm (Double armed)	 CVF-22 	6-0	0.7	30	75	BLUE	36	Surgalloy™	VPF-733-X
		5-0	1	30	75	BLUE	36	Surgalloy™	VPF-710-X
		5-0	1	36	90	BLUE	36	Surgalloy™	VPF-711-X
CV-331 - CV-331 1/2 CIRCLE 16mm (Double armed)	 CV-331 	3-0	2	36	90	BLUE	12		VP972X
CV-23 1/2 CIRCLE 17mm	 CV-23 	5-0	1	30	75	BLUE	36	Surgalloy™	VP-870-X
		4-0	1.5	30	75	BLUE	36	Surgalloy™	VP-871-X
		3-0	2	30	75	BLUE	36	Surgalloy™	VP-872-X
CV-23 - CV-23 1/2 CIRCLE 17mm (Double armed)	 CV-23 	6-0	0.7	36	90	BLUE	36	Surgalloy™	VP-555X
		5-0	1	24	60	BLUE	36	Surgalloy™	VP-566X
		5-0	1	36	90	BLUE	36	Surgalloy™, Nupack™	VP-556-X
		5-0	1	36	90	BLUE	12	5 strands, Surgalloy™	VP-556MX
		5-0	1	36	90	BLUE	36		VP-660-X
		4-0	1.5	18	45	BLUE	36	Surgalloy™	VP-757-X
		4-0	1.5	36	90	BLUE	36	Pledget 3x7mm FIRM, Surgalloy™	VPP-557-X
		4-0	1.5	36	90	BLUE	36	Surgalloy™	VP-557-X
		4-0	1.5	36	90	BLUE	12	5 strands, Surgalloy™	VP-557MX
		3-0	2	36	90	BLUE	36	Surgalloy™	VP-558-X
		2-0	3	36	90	BLUE	36		VP-559-X
CVF-23 - CVF-23 1/2 CIRCLE 17mm (Double armed)	 CVF-23 	4-0	1.5	36	90	BLUE	36	Surgalloy™	VPF-557-X
CV-24 - CV-24 1/2 CIRCLE 20mm (Double armed)	 CV-24 	4-0	1.5	36	90	BLUE	36		VP-331X
CV-25 1/2 CIRCLE 22mm	 CV-25 	4-0	1.5	30	75	BLUE	36	Surgalloy™	VP-771-X

Surgipro™ II and Surgipro™ 7-0, 8-0; Sofsilik™ 8-0; Polysorb™, Biosyn™, Monosof™, Maxon™, Velosorb™ Fast sutures differ from USP and EP only in diameter. Please refer to IFU for more details.

© 2018 Medtronic. All rights reserved. Medtronic, Medtronic logo and Further, Together are trademarks of Medtronic.



™*Third party brands are trademarks of their respective owners.

All other brands are trademarks of a Medtronic company.

11/2018 US170542

SURGIPTM/SURGIPTM II

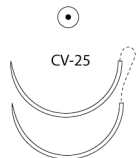
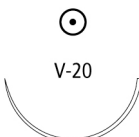
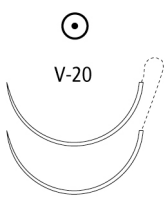
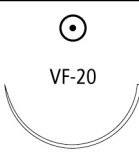
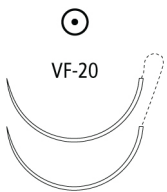
Monofilament Polypropylene Non-Absorbable Sutures

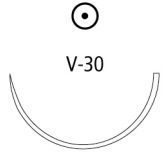
TAPER POINT									
Description	USP Size	EP Size	Length (in)	Length (cm)	Color	Units per box	Comments	Reorder code	
CV-25 - CV-25 1/2 CIRCLE 22mm (Double armed)		4-0	1.5	36	90	BLUE	12	5 strands, Surgalloy™	VP-761-MX
		4-0	1.5	36	90	BLUE	36	Surgalloy™	VP-761-X
		3-0	2	30	75	BLUE	36	Surgalloy™	VP-760-X
		3-0	2	36	90	BLUE	36	Surgalloy™	VP-762-X
V-20 1/2 CIRCLE 26mm		4-0	1.5	30	75	BLUE	36	Surgalloy™	VP-831-X
		3-0	2	30	75	BLUE	36	Surgalloy™	VP-832-X
		2-0	3	30	75	BLUE	36	Surgalloy™	VP-833
		0	3.5	30	75	BLUE	36	Surgalloy™	VP-834
V-20 - V-20 1/2 CIRCLE 26mm (Double armed)		5-0	1	30	75	BLUE	36	Surgalloy™	VP-510X
		5-0	1	36	90	BLUE	36	Surgalloy™	VP-520X
		4-0	1.5	30	75	BLUE	36	Surgalloy™	VP-511-X
		4-0	1.5	36	90	BLUE	36	Pledget 4.8x9.5mm SOFT, Surgalloy™	VP-621-X
		4-0	1.5	36	90	BLUE	36	Surgalloy™	VP-521-X
		4-0	1.5	36	90	BLUE	36	Pledget 3x7mm FIRM, Surgalloy™	VP-421X
		4-0	1.5	48	120	BLUE	36	Surgalloy™	VP-541X
		3-0	2	36	90	BLUE	36	Pledget 3x7mm FIRM, Surgalloy™	VP-422X
		3-0	2	36	90	BLUE	36	Surgalloy™	VP-522-X
		3-0	2	48	120	BLUE	36	Surgalloy™	VP-542-X
		2-0	3	36	90	BLUE	36	Surgalloy™	VP-523
		2-0	3	48	120	BLUE	36	Surgalloy™	VP-543
VF-20 1/2 CIRCLE 26mm		2-0	3	48	120	BLUE	36	Surgalloy™	VP-151
VF-20 - VF-20 1/2 CIRCLE 26mm (Double armed)		4-0	1.5	36	90	BLUE	36	Surgalloy™	VPF-521-X
		3-0	2	36	90	BLUE	36	Surgalloy™	VPF-522-X
		3-0	2	54	135	BLUE	36	Surgalloy™	VPF-354-X
		2-0	3	48	120	BLUE	36	Surgalloy™	VPF-543
GS-22 1/2 CIRCLE 27mm		2-0	3	18	45	BLUE	12	5 strands, D-Tach™	CP-16-M
		2-0	3	30	75	BLUE	36		CP-411
		0	3.5	18	45	BLUE	12	5 strands, D-Tach™	CP-17-M
		0	3.5	30	75	BLUE	36		CP-412
V-30 1/2 CIRCLE 30mm		2-0	3	30	75	BLUE	36		VP-945

Surgipro™ II and Surgipro™ 7-0, 8-0; Sofsilik™ 8-0; Polysorb™, Biosyn™, Monosof™, Maxon™, Velosorb™ Fast sutures differ from USP and EP only in diameter. Please refer to IFU for more details.

© 2018 Medtronic. All rights reserved. Medtronic, Medtronic logo and Further, Together are trademarks of Medtronic.





™*Third party brands are trademarks of their respective owners.

All other brands are trademarks of a Medtronic company.

11/2018 US170542

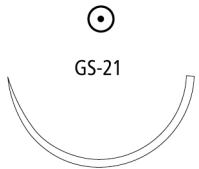
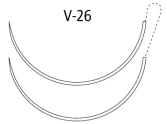
SURGIPRO™/SURGIPRO II™

Monofilament Polypropylene Non-Absorbable Sutures

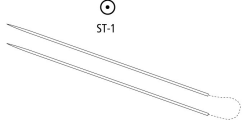
TAPER POINT									
Description	USP Size	EP Size	Length (in)	Length (cm)	Color	Units per box	Comments	Reorder code	
GS-21 1/2 CIRCLE 37mm  GS-21	3-0	2	30	75	BLUE	36		CP-422	
	2-0	3	30	75	BLUE	36		CP-423	
	0	3.5	18	45	BLUE	12	5 strands, D-Tach™	CP-10-M	
	0	3.5	30	75	BLUE	36		CP-424	
	1	4	30	75	BLUE	36		CP-425	
V-26 - V-26 1/2 CIRCLE 37mm (Double armed)  V-26 (Not to scale)	3-0	2	36	90	BLUE	36		VP-842-X	
	2-0	3	36	90	BLUE	36		VP-843	
	2-0	3	48	120	BLUE	36		VP-853	
GS-24 1/2 CIRCLE 40mm  GS-24	2-0	3	30	75	BLUE	36		CP-433	
	0	3.5	30	75	BLUE	36		CP-434	
	1	4	30	75	BLUE	36		CP-435	
	1	4	30	75	BLUE	36		CP45G	
	1	4	40	100	BLUE	36		CP-535	
GS-25 1/2 CIRCLE 48mm  GS-25 (Not to scale)	0	3.5	18	45	BLUE	12	5 strands, D-Tach™	CP-30-M	
	0	3.5	30	75	BLUE	36		CP-454	
	1	4	30	75	BLUE	36		CP-455	
GS-26 1/2 CIRCLE 65mm  GS-26 (Not to scale)	2	5	60	150	BLUE	24		CP-825	
	1	4	60	150	BLUE	24		CP-824	
GS-26 LOOP 1/2 CIRCLE 65mm  GS-26 (Not to scale)	1	4	48	120	BLUE	24		CP-824-L	
	1	4	96	240	BLUE	24		CP-834-L	
ST-1 - ST-1 STRAIGHT 51mm (Double armed)  ST-1 (Not to scale)	2-0	3	36	90	BLUE	36		GP-282	

Surgipro™ II and Surgipro™ 7-0, 8-0; Sofsilik™ 8-0; Polysorb™, Biosyn™, Monosof™, Maxon™, Velosorb™ Fast sutures differ from USP and EP only in diameter. Please refer to IFU for more details.

© 2018 Medtronic. All rights reserved. Medtronic, Medtronic logo and Further, Together are trademarks of Medtronic.



™*Third party brands are trademarks of their respective owners.

All other brands are trademarks of a Medtronic company.

11/2018 US170542

SURGIPRO™/SURGIPRO II™

Monofilament Polypropylene Non-Absorbable Sutures

HEAVY TAPER POINT									
Description	USP Size	EP Size	Length (in)	Length (cm)	Color	Units per box	Comments	Reorder code	
HGS-23 1/2 CIRCLE 22mm  HGS-23	0	3.5	18	45	BLUE	12	5 strands, D-Tach™	CP-92-M	
HGS-22 1/2 CIRCLE 27mm  HGS-22	0	3.5	30	75	BLUE	36		CP-414	
	1	4	36	90	BLUE	36		CP-415	

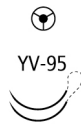
PENETRATING TAPER									
Description	USP Size	EP Size	Length (in)	Length (cm)	Color	Units per box	Comments	Reorder code	
YV-95 - YV-95 3/8 CIRCLE 9.5mm (Double armed)  YV-95	7-0	0.5	24	60	BLUE	36	Cardioint™	VP-911-X	

Surgipro™ II and Surgipro™ 7-0, 8-0; Sofsil™ 8-0; Polysorb™, Biosyn™, Monosof™, Maxon™, Velosorb™ Fast sutures differ from USP and EP only in diameter. Please refer to IFU for more details.

© 2018 Medtronic. All rights reserved. Medtronic, Medtronic logo and Further, Together are trademarks of Medtronic.







™*Third party brands are trademarks of their respective owners.

All other brands are trademarks of a Medtronic company.

11/2018 US170542

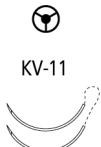
SURGI^{PRO}™/SURGI^{PRO} II™

Monofilament Polypropylene Non-Absorbable Sutures

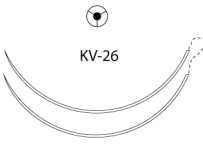
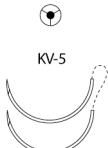
TAPERCUTTING									
Description		USP Size	EP Size	Length (in)	Length (cm)	Color	Units per box	Comments	Reorder code
KV-1 - KV-1 3/8 CIRCLE 9mm (Double armed)	 KV-1	7-0	0.5	18	45	BLUE	36	Surgalloy™	VP-721-X
		7-0	0.5	18	45	BLUE	12	5 strands, Surgalloy™	VP-721-MX
		7-0	0.5	24	60	BLUE	12	5 strands, Surgalloy™	VP-704-MX
		7-0	0.5	24	60	BLUE	36	Surgalloy™	VP-704-X
		6-0	0.7	24	60	BLUE	36	Surgalloy™	VP-712-X
		6-0	0.7	24	60	BLUE	12	5 strands, Surgalloy™	VP-712-MX
KVF-1 - KVF-1 3/8 CIRCLE 9mm (Double armed)	 KVF-1	7-0	0.5	24	60	BLUE	36	Surgalloy™	VPF-704-X
		6-0	0.7	30	75	BLUE	36	Surgalloy™, Nupack™	VPF-807-X
KV-11 - KV-11 3/8 CIRCLE 13mm (Double armed)	 KV-11	6-0	0.7	24	60	BLUE	36	Surgalloy™	VP-707-X
		6-0	0.7	30	75	BLUE	36	Surgalloy™	VP-728-X
		6-0	0.7	30	75	BLUE	12	5 strands, Surgalloy™	VP-728-MX
		5-0	1	30	75	BLUE	36	Surgalloy™	VP-708-X
		5-0	1	36	90	BLUE	36	Surgalloy™	VP-751-X
KVF-11 - KVF-11 3/8 CIRCLE 13mm (Double armed)	 KVF-11	6-0	0.7	30	75	BLUE	36	Surgalloy™	VPF-728-X
KV-15 3/8 CIRCLE 17mm	 KV-15	5-0	1	30	75	BLUE	36	Surgalloy™	VP-941-X
		4-0	1.5	30	75	BLUE	36	Surgalloy™	VP-942-X
KV-15 - KV-15 3/8 CIRCLE 17mm (Double armed)	 KV-15	5-0	1	30	75	BLUE	36	Surgalloy™	VP-914-X
		5-0	1	36	90	BLUE	36	Surgalloy™	VP-924-X
		4-0	1.5	36	90	BLUE	36	Surgalloy™	VP-925-X
		3-0	2	36	90	BLUE	36	Surgalloy™	VP-926-X
KV-26 - KV-26 3/8 CIRCLE 26mm (Double armed)	 KV-26	4-0	1.5	48	120	BLUE	36	Surgalloy™	VP-965
		3-0	2	36	90	BLUE	36		VP-956
KV-5 - KV-5 1/2 CIRCLE 17mm (Double armed)	 KV-5	5-0	1	36	90	BLUE	36	Surgalloy™	VP-934-X
		4-0	1.5	36	90	BLUE	36	Pledget 3x7mm FIRM	VP-435-X
		4-0	1.5	36	90	BLUE	36	Surgalloy™	VP-935-X
		3-0	2	36	90	BLUE	36	Surgalloy™	VP-936-X
		2-0	3	36	90	BLUE	36	Surgalloy™	VP-937

Surgipro™ II and Surgipro™ 7-0, 8-0; Sofsilik™ 8-0; Polysorb™, Biosyn™, Monosof™, Maxon™, Velosorb™ Fast sutures differ from USP and EP only in diameter. Please refer to IFU for more details.

© 2018 Medtronic. All rights reserved. Medtronic, Medtronic logo and Further, Together are trademarks of Medtronic.

™*Third party brands are trademarks of their respective owners.



All other brands are trademarks of a Medtronic company.

11/2018 US170542

SURGIPTM/SURGIPTM II

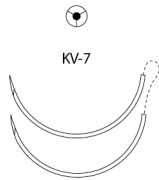
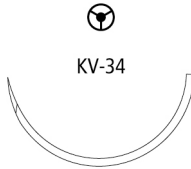
Monofilament Polypropylene Non-Absorbable Sutures

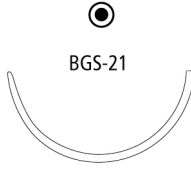
TAPERCUTTING									
Description	USP Size	EP Size	Length (in)	Length (cm)	Color	Units per box	Comments	Reorder code	
KV-7 - KV-7 1/2 CIRCLE 26mm (Double armed)  KV-7	4-0	1.5	36	90	BLUE	36	Surgalloy™	VP-975-X	
	3-0	2	36	90	BLUE	36	Pledget 3x7mm FIRM, Surgalloy™	VP-986-X	
	3-0	2	36	90	BLUE	36	Surgalloy™	VP-976-X	
	2-0	3	36	90	BLUE	36	Surgalloy™	VP-977	
	0	3.5	36	90	BLUE	36	Surgalloy™	VP-978	
KV-34 1/2 CIRCLE 37mm  KV-34	0	3.5	30	75	BLUE	36		CP-844	
	1	4	30	75	BLUE	36		CP-845	

BLUNT TAPER POINT									
Description	USP Size	EP Size	Length (in)	Length (cm)	Color	Units per box	Comments	Reorder code	
BGS-21 1/2 CIRCLE 37mm  BGS-21	0	3.5	30	75	BLUE	36	Protect Point™	CP-957	
BGS-25 1/2 CIRCLE 48mm (Not to scale)  BGS-25	1	4	40	100	BLUE	36	Protect Point™	CP-836	

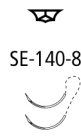
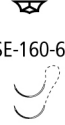
PREMIUM SPATULA									
Description	USP Size	EP Size	Length (in)	Length (cm)	Color	Units per box	Comments	Reorder code	
SE-140-8 - SE-140-8 3/8 CIRCLE 6.3mm (Double armed)  SE-140-8	10-0	0.2	12	30	BLUE	12	Surgalloy™	P-2771K	
SE-160-6 - SE-160-6 1/2 CIRCLE 5.5mm (Double armed)  SE-160-6	10-0	0.2	12	30	BLUE	12	Surgalloy™	P-2756K	

Surgipro™ II and Surgipro™ 7-0, 8-0; Sofsilik™ 8-0; Polysorb™, Biosyn™, Monosof™, Maxon™, Velosorb™ Fast sutures differ from USP and EP only in diameter. Please refer to IFU for more details.

© 2018 Medtronic. All rights reserved. Medtronic, Medtronic logo and Further, Together are trademarks of Medtronic.

™*Third party brands are trademarks of their respective owners.

All other brands are trademarks of a Medtronic company.

11/2018 US170542

SURGIPRO™/SURGIPRO II™

Monofilament Polypropylene Non-Absorbable Sutures

PREMIUM CONVENTIONAL CUTTING								
Description	USP Size	EP Size	Length (in)	Length (cm)	Color	Units per box	Comments	Reorder code
PC-13 3/8 CIRCLE 11mm	6-0	0.7	18	45	BLUE	36		SP-1617
	5-0	1	18	45	BLUE	36		SP-1618
PC-11 3/8 CIRCLE 16mm	6-0	0.7	18	45	BLUE	36		SP-1636
	5-0	1	18	45	BLUE	36	Surgalloy™	SP-1635
	4-0	1.5	18	45	BLUE	36		SP-1634
PC-12 3/8 CIRCLE 19mm	4-0	1.5	18	45	BLUE	36		SP-1644
	3-0	2	18	45	BLUE	36		SP-1643

Surgipro™ II and Surgipro™ 7-0, 8-0; Sofsilik™ 8-0; Polysorb™, Biosyn™, Monosof™, Maxon™, Velosorb™ Fast sutures differ from USP and EP only in diameter. Please refer to IFU for more details.

© 2018 Medtronic. All rights reserved. Medtronic, Medtronic logo and Further, Together are trademarks of Medtronic.

™*Third party brands are trademarks of their respective owners.

All other brands are trademarks of a Medtronic company.

11/2018 US170542

SURGIPTM/SURGIPTM II

Monofilament Polypropylene Non-Absorbable Sutures

Reorder Code	Page	Reorder Code	Page	Reorder Code	Page
3-CP-360	119	SP-1618	134	SP-623-BC	122
CP-10-M	130	SP-1634	134	SP-624-BC	119
CP-16-M	129	SP-1635	134	SP-629	119
CP-17-M	129	SP-1636	134	SP-631	119
CP-30-M	130	SP-1643	134	SP-649	119
CP-411	129	SP-1644	134	SP-655	119
CP-412	129	SP1647G	121	SP-660	119
CP-414	131	SP-1693G	121	SP-660G	119
CP-415	131	SP-1696	121	SP-661	119
CP-422	130	SP-1696G	121	SP-661G	119
CP-423	130	SP-1697	121	SP-665	119
CP-424	130	SP-2698G	121	SP-665G	119
CP-425	130	SP-5563	122	SP-670	119
CP-433	130	SP-5587	121	SP-675	119
CP-434	130	SP-559G	119	SP-683	119
CP-435	130	SP-5663	122	SP-683G	119
CP-443	120	SP-5663G	122	SP-684	119
CP-453	120	SP-5680G	121	SP-684G	119
CP-454	130	SP-5681	121	SP-685	119
CP-455	130	SP-5681G	121	SP-689	119
CP45G	130	SP-5682	121	SP-690	119
CP-460	120	SP-5682G	121	SP690G	119
CP-535	130	SP-5686	121	SP-868	119
CP-824	130	SP-5686G	121	SP-868G	119
CP-824-L	130	SP-5687	121	VP-102MX	124
CP-825	130	SP-5687G	121	VP-120MX	126
CP-834-L	130	SP-5692G	121	VP-126MX	126
CP-836	133	SP-5695	121	VP-151	129
CP-844	133	SP-5695-G	121	VP-204-X	127
CP-845	133	SP-5697G	121	VP-205-X	127
CP-92-M	131	SP-5698	121	VP-209MX	123
CP-957	133	SP-5698-G	121	VP-331X	128
GP-282	130	SP-5699	121	VP-363X	126
P-2756K	133	SP-5699G	121	VP-365X	124
P-2771K	133	SP-621	122	VP-37MX	124
P-2790G	123	SP-622	122	VP-421X	129
P-2795G	123	SP-622-BC	122	VP-422X	129
SP-1606	121	SP622G	122	VP-435-X	132
SP-1617	134	SP-623	122	VP-510X	129

Surgipro™ II and Surgipro™ 7-0, 8-0; Sofsilik™ 8-0; Polysorb™, Biosyn™, Monosoft™, Maxon™, Velosorb™ Fast sutures differ from USP and EP only in diameter.

Please refer to IFU for more details.

© 2018 Medtronic. All rights reserved. Medtronic, Medtronic logo and Further, Together are trademarks of Medtronic.

™*Third party brands are trademarks of their respective owners.

All other brands are trademarks of a Medtronic company.

11/2018 US170542

SURGIPTM/SURGIPTM II

Monofilament Polypropylene Non-Absorbable Sutures

Reorder Code	Page	Reorder Code	Page	Reorder Code	Page
VP-511-X	129	VP-704-MX	132	VP-734-MX	123
VP-520X	129	VP-704-X	132	VP-735-MX	123
VP-521-X	129	VP-705-MX	126	VP-735-X	123
VP-522-X	129	VP-705-X	126	VP-736-M	123
VP-523	129	VP-706-MX	126	VP-737-MX	123
VP-532X	127	VP-706-X	126	VP-738-MX	123
VP-533	127	VP-707-X	132	VP-738-X	123
VP-541X	129	VP-708-X	132	VP-73-MX	124
VP-542-X	129	VP-709-MX	124	VP-73-X	124
VP-543	129	VP-709-X	124	VP-743-MX	123
VP-555X	128	VP-70-X	125	VP-744-MX	123
VP-556MX	128	VP-710-MX	127	VP-744-X	123
VP-556-X	128	VP-710-X	127	VP-745-X	123
VP-557MX	128	VP-711-X	127	VP-746-MX	124
VP-557-X	128	VP-712-MX	132	VP-746-X	124
VP-558-X	128	VP-712-X	132	VP-747-MX	123
VP-559-X	128	VP-713-MX	124	VP-747-X	123
VP-566X	128	VP-713-X	124	VP-74-X	125
VP-570X	127	VP-714-X	127	VP-751-X	132
VP-580-X	127	VP-715-X	127	VP-753-MX	123
VP-581-X	127	VP-718-MX	126	VP-754-X	127
VP-582-X	127	VP-718-X	126	VP-755-X	127
VP-583-X	127	VP-719-MX	126	VP-757-X	128
VP-584-X	127	VP-719-X	126	VP-759-MX	124
VP-585-X	127	VP-720-MX	126	VP-75-X	125
VP-621-X	129	VP-720-X	126	VP760MX	124
VP-628	123	VP-721-MX	132	VP-760-X	129
VP-630-X	123	VP-721-X	132	VP-761-MX	129
VP-631-X	123	VP-725-MX	126	VP-761-X	129
VP-652-MX	127	VP-725-X	126	VP-762-X	129
VP-653-MX	127	VP-726-MX	126	VP763MX	124
VP-660-X	128	VP-726-X	126	VP-763-X	124
VP-681-X	126	VP-727-X	126	VP-765-MX	125
VP-701-MX	124	VP-728-MX	132	VP-76-MX	125
VP-701-X	124	VP-728-X	132	VP-76-X	125
VP-702-MX	124	VP-72-MX	124	VP-771-X	128
VP-702-X	124	VP-72-X	124	VP-772-X	127
VP-703-MX	124	VP-733-MX	127	VP-776-X	125
VP-703-X	124	VP-733-X	127	VP-78-X	126

Surgipro™ II and Surgipro™ 7-0, 8-0; Sofsilik™ 8-0; Polysorb™, Biosyn™, Monosoft™, Maxon™, Velosorb™ Fast sutures differ from USP and EP only in diameter.

Please refer to IFU for more details.

© 2018 Medtronic. All rights reserved. Medtronic, Medtronic logo and Further, Together are trademarks of Medtronic.

™*Third party brands are trademarks of their respective owners.

All other brands are trademarks of a Medtronic company.

11/2018 US170542

SURGIPTM/SURGIPTM II

Monofilament Polypropylene Non-Absorbable Sutures

Reorder Code	Page	Reorder Code	Page	Reorder Code	Page
VP-800-X	126	VP-936-X	132		
VP-812-X	126	VP-937	132		
VP-813-X	126	VP-941-X	132		
VP-831-X	129	VP-942-X	132		
VP-832-X	129	VP-945	129		
VP-833	129	VP-956	132		
VP-834	129	VP-965	132		
VP-841-X	127	VP972X	128		
VP-842-X	130	VP-973-X	123		
VP-843	130	VP-975-X	133		
VP-851-X	127	VP-976-X	133		
VP-853	130	VP-977	133		
VP-854-X	127	VP-978	133		
VP86X	126	VP-986-X	133		
VP-870-X	128	VPF-354-X	129		
VP-871-X	128	VPF-521-X	129		
VP-872-X	128	VPF-522-X	129		
VP-875-MX	124	VPF-543	129		
VP-875-X	124	VPF-557-X	128		
VP-881-X	126	VPF-610-X	127		
VP-889-X	125	VPF-702-X	124		
VP-890-X	125	VPF-703-MX	124		
VP-891	125	VPF-703-X	124		
VP-897-M	126	VPF-704-X	132		
VP-900-MX	123	VPF-706-X	126		
VP-900-X	123	VPF-709-X	124		
VP-901-MX	123	VPF-710-X	128		
VP-902-MX	123	VPF-711-X	128		
VP-902-X	123	VPF-713-X	124		
VP-903-MX	123	VPF-720-X	126		
VP-904-MX	123	VPF-726-X	126		
VP-904-X	123	VPF-728-X	132		
VP-911-X	131	VPF-733-X	128		
VP-914-X	132	VPF-735-X	124		
VP-924-X	132	VPF-776-X	125		
VP-925-X	132	VPF-807-X	132		
VP-926-X	132	VPP-557-X	128		
VP-934-X	132				
VP-935-X	132				

Surgipro™ II and Surgipro™ 7-0, 8-0; Sofsilik™ 8-0; Polysorb™, Biosyn™, Monosoft™, Maxon™, Velosorb™ Fast sutures differ from USP and EP only in diameter. Please refer to IFU for more details.

© 2018 Medtronic. All rights reserved. Medtronic, Medtronic logo and Further, Together are trademarks of Medtronic.

™*Third party brands are trademarks of their respective owners.

All other brands are trademarks of a Medtronic company.

11/2018 US170542

TI-CRON™/SURGIDAC™

Coated and Uncoated Braided Polyester Non-Absorbable Sutures

Description	<p>Ti-Cron™ and Surgidac™ polyester sutures are non absorbable, sterile, surgical sutures composed of Polyethylene Terephthalate. They are prepared from fibers of high molecular weight, long-chain, linear polyesters having recurrent aromatic rings as an integral component. Ti-Cron™ braided sutures are available coated uniformly with silicone to increase surface lubricity, thereby enhancing handling characteristics, ease of passage through tissue, and knot run-down properties. Surgidac™ monofilament sutures are uncoated and the braided sutures are available uncoated or coated uniformly with polybutylene adipate to increase surface lubricity, thereby enhancing handling characteristics, ease of passage through tissue, and knot run-down properties.</p>
Indications	<p>Ti-Cron™ and Surgidac™ polyester sutures are indicated for use in general soft tissue approximation and/or ligation, including use in cardiovascular, ophthalmic and neurological surgery.</p>
Actions	<p>Ti-Cron™ and Surgidac™ polyester sutures elicit a minimal acute inflammatory reaction in tissues, followed by gradual encapsulation of the suture by fibrous connective tissue.</p>
Tensile Strength	<p>Ti-Cron™ and Surgidac™ polyester sutures are not absorbed, nor is any significant change in tensile strength retention known to occur in vivo.</p>
Sterilization	<p>Ti-Cron™ and Surgidac™ polyester sutures in sizes 6-0 or smaller or pledgeted sutures are sterilized by ethylene oxide. Sizes 5-0 or greater are sterilized by gamma irradiation.</p>
Packaging	<p>Ti-Cron™ polyester sutures are available undyed (white) or dyed with D&C Blue No. 6 and braided, coated, in sizes 5 (7 Metric) through 7-0 (0.5 Metric). Surgidac™ polyester sutures are available undyed (white), braided and uncoated in USP and EP sizes 2 (5 Metric) through 6-0 (0.7 Metric). Ti-Cron™ and Surgidac™ polyester sutures are supplied sterile, in pre-cut lengths and ligating reels, non-needled or affixed to various needle types using both permanent and removable needle attachment techniques. Ti-Cron™ polyester sutures are also available with PTFE (polytetrafluorethylene) pledgets for use as a pad between the suture area and the tissue surface to increase the load bearing area. Please refer to the individual package IFUs for complete instructions, indications, contraindications, warnings and precautions.</p>

TI-CRON™/SURGIDAC™

Coated and Uncoated Braided Polyester Non-Absorbable Sutures

NON NEEDLED - PRE-CUT								
Description	USP Size	EP Size	Length (in)	Length (cm)	Color	Units per box	Comments	Reorder code
PRE-CUT	5-0	1	18	45	BLUE	36	12 strands	88863008-21
	4-0	1.5	18	45	BLUE	36	12 strands	88863008-31
	4-0	1.5	30	75	BLUE	24	12 strands	88863003-32
	3-0	2	18	45	BLUE	36	6 strands	88863001-41
	3-0	2	18	45	BLUE	36	12 strands	88863008-41
	3-0	2	30	75	BLUE	24	12 strands	88863003-42
	2-0	3	18	45	WHITE	12	5 strands	88863011-51
	2-0	3	18	45	BLUE	36	12 strands	88863008-51
	2-0	3	30	75	BLUE	24	12 strands	88863003-52
	0	3.5	18	45	BLUE	24	6 strands	88863001-62
	0	3.5	30	75	BLUE	24	6 strands	88863002-62
	1	4	18	45	BLUE	24	6 strands	88863001-72

NON NEEDLED - REEL								
Description	USP Size	EP Size	Length (in)	Length (cm)	Color	Units per box	Comments	Reorder code
REEL	3-0	2	100	250	BLUE	24		88863380-42
	2-0	3	100	250	BLUE	24		88863380-52
	0	3.5	100	250	BLUE	24		88863380-62
	2	5	100	250	BLUE	24		88863380-82
	5	7	60	150	BLUE	24		88863381-89
	3&4	6	60	150	BLUE	24		88863381-09
	1	4	100	250	BLUE	24		88863380-72

Surgipro™ II and Surgipro™ 7-0, 8-0; Sofsilik™ 8-0; Polysorb™, Biosyn™, Monosof™, Maxon™, Velosorb™ Fast sutures differ from USP and EP only in diameter. Please refer to IFU for more details.

© 2018 Medtronic. All rights reserved. Medtronic, Medtronic logo and Further, Together are trademarks of Medtronic.







™*Third party brands are trademarks of their respective owners.

All other brands are trademarks of a Medtronic company.

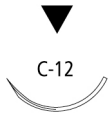
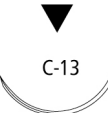
11/2018 US170542

TI-CRON™/SURGIDAC™

Coated and Uncoated Braided Polyester Non-Absorbable Sutures

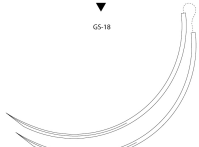
REVERSE CUTTING									
Description	USP Size	EP Size	Length (in)	Length (cm)	Color	Units per box	Comments	Reorder code	
C-12 3/8 CIRCLE 16mm 	5-0	1	18	45	BLUE	36		88863045-21	
	4-0	1.5	30	75	BLUE	36	Reliapoint™needle	88863046-31	
C-13 3/8 CIRCLE 19mm 	4-0	1.5	18	45	BLUE	36	Reliapoint™needle	88863047-31	
	3-0	2	18	45	BLUE	36	Reliapoint™needle	88863047-41	
	3-0	2	30	75	BLUE	36	Reliapoint™needle	88863055-41	
	2-0	3	30	75	BLUE	36	Reliapoint™needle	88863048-51	
C-14 3/8 CIRCLE 24mm 	3-0	2	18	45	BLUE	36	Reliapoint™needle	88863069-41	
	3-0	2	30	75	BLUE	36	Reliapoint™needle	88863050-41	
	2-0	3	30	75	BLUE	36	Reliapoint™needle	88863050-51	
	2-0	3	36	90	BLUE	36	Reliapoint™needle	88863065-51	
	0	3.5	30	75	BLUE	36	Reliapoint™needle	88863050-61	
	0	3.5	36	90	BLUE	36	Reliapoint™needle	88863065-61	
C-15 3/8 CIRCLE 26mm 	2-0	3	30	75	BLUE	36	Reliapoint™needle	88863070-51	
C-16 3/8 CIRCLE 30mm 	2-0	3	30	75	BLUE	36	Reliapoint™needle	88863023-51	
	0	3.5	30		BLUE	36	Reliapoint™needle	8886302361	
	0	3.5	36	90	BLUE	36	Reliapoint™needle	88863012-61	
	1	4	30	75	BLUE	36	Reliapoint™needle	88863023-71	
C-17 3/8 CIRCLE 39mm 	2-0	3	30	75	BLUE	36	Reliapoint™needle	88863054-51	
	0	3.5	30	75	BLUE	36	Reliapoint™needle	88863054-61	
	2	5	30	75	BLUE	36	Reliapoint™needle	88863054-81	
	1	4	30	75	BLUE	36	Reliapoint™needle	88863054-71	
GS-18 3/8 CIRCLE 77mm (Not to scale) 	5	7	18	45	BLUE	12		88863056-89	
GS-18 - GS-18 3/8 CIRCLE 77mm (Double armed) (Not to scale) 	2	5	30	75	BLUE	24		88863128-82	
	2	5	30	75	GREEN	24		CD-496	
	5	7	30	75	BLUE	24		88863128-79	

Surgipro™ II and Surgipro™ 7-0, 8-0; Sofsilik™ 8-0; Polysorb™, Biosyn™, Monosof™, Maxon™, Velosorb™ Fast sutures differ from USP and EP only in diameter. Please refer to IFU for more details.

© 2018 Medtronic. All rights reserved. Medtronic, Medtronic logo and Further, Together are trademarks of Medtronic.

™*Third party brands are trademarks of their respective owners.

All other brands are trademarks of a Medtronic company.

11/2018 US170542

TI-CRON™/SURGIDAC™

Coated and Uncoated Braided Polyester Non-Absorbable Sutures

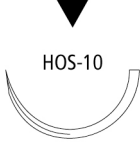
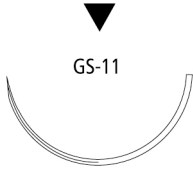
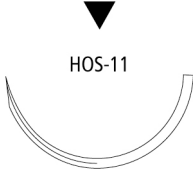
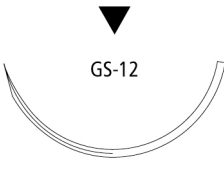
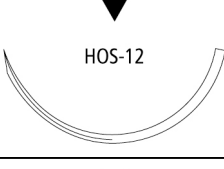
REVERSE CUTTING									
Description	USP Size	EP Size	Length (in)	Length (cm)	Color	Units per box	Comments	Reorder code	
HOS-10 1/2 CIRCLE 26mm 	2-0	3	30	75	BLUE	36		88863395-51	
	0	3.5	30	75	BLUE	36		88863395-61	
	2	5	30	75	BLUE	36		88863395-81	
	1	4	30	75	BLUE	36		88863395-71	
GS-11 1/2 CIRCLE 37mm 	2-0	3	30	75	BLUE	36		88863309-51	
	0	3.5	30	75	BLUE	36		88863309-61	
	3&4	6	30	75	BLUE	36		88863154-09	
	1	4	30	75	BLUE	36		88863309-71	
HOS-11 1/2 CIRCLE 37mm 	2	5	30	75	BLUE	36		88863028-81	
	1	4	30	75	BLUE	36		88863028-71	
GS-12 1/2 CIRCLE 40mm 	2	5	30	75	BLUE	36		88863155-81	
HOS-12 1/2 CIRCLE 40mm 	2	5	30	75	BLUE	36		88863026-81	
	1	4	30	75	BLUE	36		88863026-71	
HOS-14 1/2 CIRCLE 55mm (Not to scale) 	5	7	30	75	BLUE	36		88863027-79	

Surgipro™ II and Surgipro™ 7-0, 8-0; Sofsilik™ 8-0; Polysorb™, Biosyn™, Monosof™, Maxon™, Velosorb™ Fast sutures differ from USP and EP only in diameter. Please refer to IFU for more details.

© 2018 Medtronic. All rights reserved. Medtronic, Medtronic logo and Further, Together are trademarks of Medtronic.



™*Third party brands are trademarks of their respective owners.

All other brands are trademarks of a Medtronic company.

11/2018 US170542

TI-CRON™/SURGIDAC™

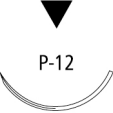
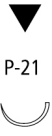
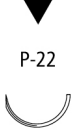
Coated and Uncoated Braided Polyester Non-Absorbable Sutures

PREMIUM REVERSE CUTTING									
Description	USP Size	EP Size	Length (in)	Length (cm)	Color	Units per box	Comments	Reorder code	
P-13 3/8 CIRCLE 13mm 	5-0	1	18	45	WHITE	12	Edgellant™ needle, Surgalloy™ alloy	SCD-2864G	
	5-0	1	18	45	BLUE	12	Edgellant™ needle, Surgalloy™ alloy	SCD-3058G	
	4-0	1.5	18	45	BLUE	12	Edgellant™ needle, Surgalloy™ alloy	SCD-3059G	
	4-0	1.5	18	45	WHITE	12	Surgalloy™	88862862-34	
P-12 3/8 CIRCLE 19mm 	4-0	1.5	18	45	BLUE	12	Edgellant™ needle, Surgalloy™ alloy	SCD-3049G	
P-21 1/2 CIRCLE 9mm 	4-0	1.5	18	45	WHITE	12	Edgellant™ needle, Surgalloy™ alloy	88862854-33	
P-22 1/2 CIRCLE 13mm 	3-0	2	18	45	BLUE	12	Surgalloy™	88863109-43	
P-24 1/2 CIRCLE 16mm 	2-0	3	18	45	BLUE	12		88863059-53	

Surgipro™ II and Surgipro™ 7-0, 8-0; Sofsilik™ 8-0; Polysorb™, Biosyn™, Monosof™, Maxon™, Velosorb™ Fast sutures differ from USP and EP only in diameter. Please refer to IFU for more details.

© 2018 Medtronic. All rights reserved. Medtronic, Medtronic logo and Further, Together are trademarks of Medtronic.

™*Third party brands are trademarks of their respective owners.

All other brands are trademarks of a Medtronic company.

11/2018 US170542

TI-CRON™/SURGIDAC™

Coated and Uncoated Braided Polyester Non-Absorbable Sutures

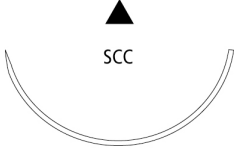
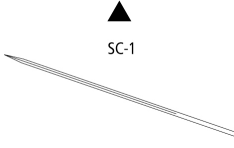
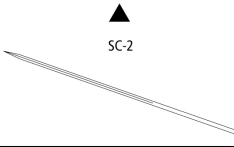
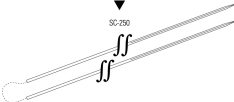
CONVENTIONAL CUTTING									
Description	USP Size	EP Size	Length (in)	Length (cm)	Color	Units per box	Comments	Reorder code	
SCC 1/2 CIRCLE 48mm (Not to scale)	5	7	30	75	BLUE	6	5 strands	88863127-79	
SC-1 STRAIGHT 51mm (Not to scale)	2-0	3	30	75	BLUE	36		88863163-51	
	0	3.5	30	75	BLUE	36		88863163-61	
	1	4	30	75	BLUE	36		88863163-71	
SC-2 STRAIGHT 60mm (Not to scale)	3-0	2	30	75	BLUE	36		88863062-41	
	2-0	3	30	75	BLUE	36		88863062-51	
	2-0	3	36	90	BLUE	36		88863165-51	
	0	3.5	30	75	BLUE	36		8886306261	
SC-250 - SC-250 STRAIGHT 254mm (Double armed) (Not to scale)	2-0	3	30	75	BLUE	12		88862947-53	

Surgipro™ II and Surgipro™ 7-0, 8-0; Sofsilik™ 8-0; Polysorb™, Biosyn™, Monosof™, Maxon™, Velosorb™ Fast sutures differ from USP and EP only in diameter. Please refer to IFU for more details.

© 2018 Medtronic. All rights reserved. Medtronic, Medtronic logo and Further, Together are trademarks of Medtronic.









™*Third party brands are trademarks of their respective owners.

All other brands are trademarks of a Medtronic company.

11/2018 US170542

TI-CRON™/SURGIDAC™

Coated and Uncoated Braided Polyester Non-Absorbable Sutures

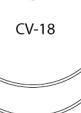
TAPER POINT									
Description	USP Size	EP Size	Length (in)	Length (cm)	Color	Units per box	Comments	Reorder code	
CV-310 - CV-310 3/8 CIRCLE 10mm (Double armed) 	7-0	0.5	18	45	BLUE	36	Cardiopoint™	88863288-01	
CV-11 3/8 CIRCLE 13mm 	5-0	1	30	75	BLUE	36	Surgalloy™	88863104-21	
CV-301 3/8 CIRCLE 13mm 	4-0	1.5	30	75	BLUE	36	Cardiopoint™	88863106-31	
CV-301 - CV-301 3/8 CIRCLE 13mm (Double armed) 	6-0	0.7	30	75	BLUE	36	Cardiopoint™	88863280-11	
	6-0	0.7	30	75	BLUE			VCD8011G	
	5-0	1	30	75	BLUE	36	Cardiopoint™	88863280-21	
	5-0	1	30	75	WHITE	36	Cardiopoint™	88862801-21	
	5-0	1	30	75	BLUE	36	Pledget 3x3mm FIRM, Cardiopoint™	88863314-21	
	4-0	1.5	30	75	BLUE	36	Pledget 3x3mm FIRM	88863314-31	
	4-0	1.5	30	75	BLUE	36	Cardiopoint™	88863280-31	
	3-0	2	30	75	BLUE	36	Cardiopoint™	88863280-41	
CV-307 - CV-307 3/8 CIRCLE 16mm (Double armed) 	4-0	1.5	30	75	BLUE	36	Cardiopoint™	88863229-31	
	3-0	2	30	75	BLUE	36	Cardiopoint™	88863229-41	
CV-15 - CV-15 3/8 CIRCLE 17mm (Double armed) 	2-0	3	36	90	5BLUE & 5WHITE	6	5 strands, Surgalloy™	8886263656	
CV-327 - CV-327 3/8 CIRCLE 18mm (Double armed) 	5-0	1	30	75	BLUE	36	Cardiopoint™	88862775-21	
	4-0	1.5	30	75	BLUE	36	Cardiopoint™	88862775-31	
	3-0	2	30	75	BLUE	36	Cardiopoint™	88862775-41	
CV-13 - CV-13 3/8 CIRCLE 22mm (Double armed) 	3-0	2	36	90	BLUE	36	Surgalloy™	88862627-41	
CV-18 - CV-18 3/8 CIRCLE 26mm (Double armed) 	2-0	3	36	90	5BLUE & 5WHITE	6	10 strands	88863230-56	

Surgipro™ II and Surgipro™ 7-0, 8-0; Sofsilik™ 8-0; Polysorb™, Biosyn™, Monosof™, Maxon™, Velosorb™ Fast sutures differ from USP and EP only in diameter. Please refer to IFU for more details.

© 2018 Medtronic. All rights reserved. Medtronic, Medtronic logo and Further, Together are trademarks of Medtronic.





™*Third party brands are trademarks of their respective owners.

All other brands are trademarks of a Medtronic company.

11/2018 US170542

TI-CRON™/SURGIDAC™

Coated and Uncoated Braided Polyester Non-Absorbable Sutures

TAPER POINT									
Description		USP Size	EP Size	Length (in)	Length (cm)	Color	Units per box	Comments	Reorder code
CV-337 - CV-337 1/2 CIRCLE 10mm (Double armed)		5-0	1	30	75	BLUE	36	Cardioint™	88863298-21
		5-0	1	36	90	BLUE	36	Cardioint™	88863139-21
		5-0	1	36	90	BLUE	36	Pledget 3x3mm FIRM	88863297-21
CV-330 - CV-330 1/2 CIRCLE 13mm (Double armed)		5-0	1	24	60	BLUE	36	Cardioint™	88863226-21
		4-0	1.5	24	60	BLUE	36	Cardioint™	88863226-31
		4-0	1.5	36	90	BLUE	36	Cardioint™	88863249-31
		3-0	2	18	45	BLUE	36	Pledget 3x3mm FIRM	88863295-41
		3-0	2	24	60	BLUE	36	Cardioint™	88863226-41
CV-331 1/2 CIRCLE 16mm		5-0	1	30	75	BLUE	36	Cardioint™	88863186-21
		4-0	1.5	30	75	BLUE	36	Cardioint™	88863186-31
		3-0	2	30	75	BLUE	36	Cardioint™	88863186-41
		2-0	3	30	75	BLUE	36	Cardioint™	88863186-51
CV-331 - CV-331 1/2 CIRCLE 16mm (Double armed)		5-0	1	36	90	BLUE	36	Cardioint™	88863271-21
		4-0	1.5	30	75	BLUE	36	Cardioint™	88863087-31
		4-0	1.5	36	90	BLUE	36	Cardioint™	88863271-31
		3-0	2	30	75	BLUE	36	Cardioint™	88863087-41
		3-0	2	30	75	BLUE	6	10 strands, Cardioint™	88863084-46
		3-0	2	36	90	BLUE	36	Cardioint™	88863271-41
		2-0	3	30	75	4BLUE & 4WHITE	6	8 strands, Pledget 3x7mm FIRM	88863091-56
		2-0	3	30	75	4BLUE & 4WHITE	6	8 strands	88863083-56
		2-0	3	30	75	BLUE	36	Cardioint™	88863087-51
		2-0	3	30	75	4BLUE & 4WHITE	6	8 strands, Pledget 3x3mm FIRM	88863086-56
		2-0	3	30	75	BLUE	6	10 strands, Cardioint™	88863084-56
		2-0	3	30	75	4BLUE & 4WHITE	6	8 strands, Oval Pledget 3x6mm FIRM, Cardioint™	VCD20331FE
		2-0	3	30	75	4BLUE & 4WHITE	6	4 strands	VCD20331SE
		2-0	3	36	90	5BLUE & 5WHITE	6	10 strands, Pledget 3x7mm FIRM	88863269-56
		2-0	3	36	90	5BLUE & 5WHITE	6	10 strands, Pledget 3x3mm FIRM	88863273-56
CV-24 1/2 CIRCLE 20mm		3-0	2	18	45	BLUE	24	5 strands, D- Tach™	88863267-42

Surgipro™ II and Surgipro™ 7-0, 8-0; Sofsilik™ 8-0; Polysorb™, Biosyn™, Monosof™, Maxon™, Velosorb™ Fast sutures differ from USP and EP only in diameter. Please refer to IFU for more details.

© 2018 Medtronic. All rights reserved. Medtronic, Medtronic logo and Further, Together are trademarks of Medtronic.



™*Third party brands are trademarks of their respective owners.

All other brands are trademarks of a Medtronic company.

11/2018 US170542

TI-CRON™/SURGIDAC™

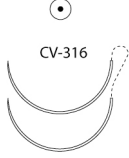
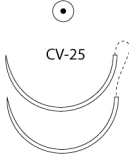
Coated and Uncoated Braided Polyester Non-Absorbable Sutures

TAPER POINT								
Description	USP Size	EP Size	Length (in)	Length (cm)	Color	Units per box	Comments	Reorder code
CV-316 - CV-316 1/2 CIRCLE 20mm (Double armed) 	4-0	1.5	30	75	BLUE	36	Pledget 3x7mm FIRM	88863348-31
	4-0	1.5	36	90	BLUE	36	Cardioint™	88863369-31
	3-0	2	30	75	BLUE	36	Cardioint™	88863227-41
	3-0	2	36	90	BLUE	36	Cardioint™	88863369-41
	2-0	3	30	75	WHITE	36	Pledget 3x7mm FIRM	88862978-51
	2-0	3	30	75	BLUE	36	Pledget 3x7mm FIRM	88863348-51
	2-0	3	30	75	5BLUE & 5WHITE	6	10 strands, Cardioint™	88863385-56
	2-0	3	30	75	5BLUE & 5WHITE	6	10 strands, Pledget 3x7mm FIRM	88863323-56
	2-0	3	30	75	BLUE	6	10 strands, Cardioint™	88863344-56
	2-0	3	30	75	5BLUE & 5WHITE	6	10 strands, Pledget 3x3mm FIRM	88863277-56
	2-0	3	30	75	BLUE	36	Cardioint™	88863227-51
	2-0	3	30	75	4BLUE & 4WHITE	6	8 strands, Pledget 3x7mm SOFT	VCD-375
	2-0	3	30	75	BLUE	36	Oval Pledget 3x6mm FIRM, Cardioint™	VCD20316FE
	2-0	3	30	75	BLUE	36	Oval Pledget 3x6mm SOFT, Cardioint™	VCD20316SE
	2-0	3	30	75	4BLUE & 4WHITE	6	8 strands, Oval Pledget 3x6mm FIRM, Cardioint™	VCD20316MFE
	2-0	3	30	75	4BLUE & 4WHITE	6	8 strands, Oval Pledget 3x6mm SOFT, Cardioint™	VCD20316MSE
	2-0	3	36	90	WHITE	36	Cardioint™	88862839-51
2-0	3	36	90	BLUE	36	Cardioint™	88863369-51	
0	3.5	30	75	BLUE	6	5 strands	VCD2346	
CV-25 - CV-25 1/2 CIRCLE 22mm (Double armed) 	3-0	2	36	90	BLUE	36	Surgalloy™	8886337041
	2-0	3	36	90	BLUE	36	Surgalloy™	88863370-51
GS-23 1/2 CIRCLE 22mm 	0	3.5	18	45	BLUE	24	5 strands, D-Tach™	88863257-62
CV-305 1/2 CIRCLE 25mm 	4-0	1.5	30	75	BLUE	36	Cardioint™	88863185-31
	3-0	2	30	75	BLUE	36	Cardioint™	88863185-41
	2-0	3	30	75	BLUE	36	Cardioint™	88863185-51
	2-0	3	30	75	BLUE	24	5 strands	88863033-52
	2-0	3	30	75	5BLUE & 5WHITE	6	10 strands, Cardioint™	88863353-56
	0	3.5	30	75	BLUE	36	Cardioint™	88863185-61
	1	4	30	75	BLUE	36	Cardioint™	88863185-71

Surgipro™ II and Surgipro™ 7-0, 8-0; Sofsilik™ 8-0; Polysorb™, Biosyn™, Monosof™, Maxon™, Velosorb™ Fast sutures differ from USP and EP only in diameter. Please refer to IFU for more details.

© 2018 Medtronic. All rights reserved. Medtronic, Medtronic logo and Further, Together are trademarks of Medtronic.

™*Third party brands are trademarks of their respective owners.

All other brands are trademarks of a Medtronic company.

11/2018 US170542

TI-CRON™/SURGIDAC™

Coated and Uncoated Braided Polyester Non-Absorbable Sutures

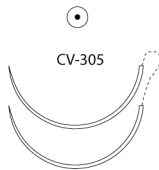
TAPER POINT								
Description	USP Size	EP Size	Length (in)	Length (cm)	Color	Units per box	Comments	Reorder code
CV-305 - CV-305 1/2 CIRCLE 25mm (Double armed) 	4-0	1.5	36	90	BLUE	36	Cardiopoint™	88863256-31
	3-0	2	36	90	BLUE	36	Pledget 3x7mm FIRM	88863336-41
	3-0	2	36	90	BLUE	36	Cardiopoint™	88863256-41
	3-0	2	42	105	BLUE	36	Cardiopoint™	88863035-41
	2-0	3	30	75	5BLUE & 5WHITE	6	10 strands, Pledget 4x8mm FIRM	88863037-56
	2-0	3	30	75	4BLUE & 4WHITE	6	8 strands, Pledget 3x7mm SOFT	VCD-346
	2-0	3	30	75	4BLUE & 4WHITE	6	8 strands, Oval Pledget 4.5x6mm SOFT, Cardiopoint™	VCD2030556 MSE
	2-0	3	30	75	4BLUE & 4WHITE	6	8 strands, Oval Pledget 3x6mm FIRM, Cardiopoint™	VCD20305MF E
	2-0	3	30	75	4BLUE & 4WHITE	6	8 strands, Oval Pledget 4.5x6mm FIRM, Cardiopoint™	VCD2030556 MFE
	2-0	3	30	75	4BLUE & 4WHITE	6	8 strands, Oval Pledget 3x6mm SOFT, Cardiopoint™	VCD20305MS E
	2-0	3	30	75	BLUE	36	Oval Pledget 3x6mm FIRM, Cardiopoint™	VCD20305FE
	2-0	3	30	75	BLUE	36	Oval Pledget 3x6mm SOFT, Cardiopoint™	VCD20305SE
	2-0	3	30	75	5BLUE & 5WHITE	6	10 strands, Pledget 3x7mm FIRM	88863324-56
	2-0	3	30	75	5BLUE & 5WHITE	6	10 strands, Cardiopoint™	88863356-56
	2-0	3	30	75	BLUE	6	5 strands	88863040-56
	2-0	3	36	90	WHITE	36	Cardiopoint™	88862914-51
	2-0	3	36	90	WHITE	36	Pledget 3x7mm FIRM	88862953-51
	2-0	3	36	90	BLUE	36	Pledget 3x7mm FIRM	88863336-51
	2-0	3	36	90	BLUE	36	Cardiopoint™	88863256-51
	2-0	3	36	90	BLUE	6	10 strands, Cardiopoint™	88863220-56
2-0	3	36	90	4BLUE & 4WHITE	6	8 strands, Pledget 3x3mm FIRM	88863307-56	
2-0	3	36	90	3BLUE & 3WHITE	6	6 strands, Pledget 3x7mm FIRM	88863306-56	
2-0	3	36	90	5BLUE & 5WHITE	6	10 strands, Cardiopoint™	88862981-56	
2-0	3	36	90	4BLUE & 4WHITE	6	8 strands, Oval Pledget 3x6mm FIRM, Cardiopoint™	VCD2036305F E	
2-0	3	42	105	BLUE	36	Cardiopoint™	88863035-51	
0	3.5	30	75	5BLUE & 5WHITE	6	10 strands, Pledget 3x7mm FIRM, Cardiopoint™	8886332466	
0	3.5	30	75	5BLUE & 5WHITE	6	10 strands, Pledget 3x7mm FIRM	88863324-66	
0	3.5	36	90	BLUE	36	Cardiopoint™	88863256-61	
0	3.5	36	90	WHITE	36	Cardiopoint™	88862914-61	

Surgipro™ II and Surgipro™ 7-0, 8-0; Sofsilik™ 8-0; Polysorb™, Biosyn™, Monosof™, Maxon™, Velosorb™ Fast sutures differ from USP and EP only in diameter. Please refer to IFU for more details.

© 2018 Medtronic. All rights reserved. Medtronic, Medtronic logo and Further, Together are trademarks of Medtronic.



™*Third party brands are trademarks of their respective owners.

All other brands are trademarks of a Medtronic company.

11/2018 US170542

TI-CRON™/SURGIDAC™

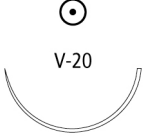
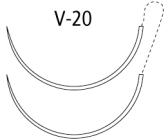
Coated and Uncoated Braided Polyester Non-Absorbable Sutures

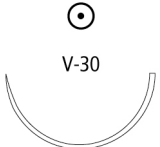
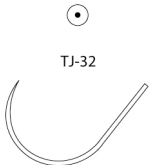
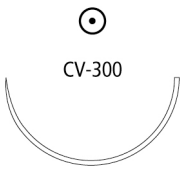
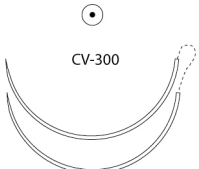
TAPER POINT									
Description	USP Size	EP Size	Length (in)	Length (cm)	Color	Units per box	Comments	Reorder code	
V-20 1/2 CIRCLE 26mm 	4-0	1.5	18	45	BLUE	24	5 strands, D-Tach™	88863258-32	
	3-0	2	18	45	BLUE	24	5 strands, D-Tach™	88863258-42	
	2-0	3	18	45	BLUE	24	5 strands, D-Tach™	88863258-52	
	2-0	3	48	120	BLUE	36		88863129-51	
	0	3.5	48	120	BLUE	36		88863015-61	
V-20 - V-20 1/2 CIRCLE 26mm (Double armed) 	2-0	3	36	90	BLUE	36	Surgalloy™	88863251-51	
GS-22 1/2 CIRCLE 27mm 	2-0	3	18	45	BLUE	24	5 strands, D-Tach™	88863259-52	
	2-0	3	30	75	BLUE	36		88863093-51	
	0	3.5	18	45	BLUE	24	5 strands, D-Tach™	88863259-62	
	0	3.5	30	75	BLUE	36		88863093-61	
V-30 1/2 CIRCLE 30mm 	3-0	2	30	75	BLUE	36		88863205-41	
	2-0	3	30	75	BLUE	36		88863205-51	
	0	3.5	30	75	BLUE	36		88863205-61	
TJ-32 1/2 CIRCLE 32mm 	1	4	30	75	BLUE	36		88863103-71	
CV-300 1/2 CIRCLE 35mm 	2-0	3	30	75	BLUE	36	Cardioint™	88863082-51	
	0	3.5	30	75	BLUE	36	Cardioint™	88863082-61	
CV-300 - CV-300 1/2 CIRCLE 35mm (Double armed) 	2-0	3	30	75	BLUE	36	Cardioint™	88863274-51	
	2-0	3	36	90	BLUE	36	Cardioint™	88863393-51	
	0	3.5	30	75	BLUE	36	Cardioint™	88863274-61	
	0	3.5	36	90	BLUE	36	Cardioint™	88863393-61	

Surgipro™ II and Surgipro™ 7-0, 8-0; Sofsilik™ 8-0; Polysorb™, Biosyn™, Monosof™, Maxon™, Velosorb™ Fast sutures differ from USP and EP only in diameter. Please refer to IFU for more details.

© 2018 Medtronic. All rights reserved. Medtronic, Medtronic logo and Further, Together are trademarks of Medtronic.



™*Third party brands are trademarks of their respective owners.

All other brands are trademarks of a Medtronic company.

11/2018 US170542

TI-CRON™/SURGIDAC™

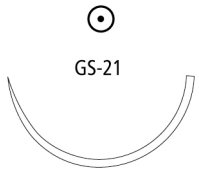
Coated and Uncoated Braided Polyester Non-Absorbable Sutures

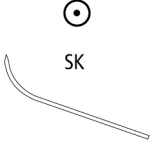
TAPER POINT									
Description	USP Size	EP Size	Length (in)	Length (cm)	Color	Units per box	Comments	Reorder code	
GS-21 1/2 CIRCLE 37mm  GS-21	2-0	3	18	45	BLUE	24	5 strands, D-Tach™	88863260-52	
	2-0	3	30	75	BLUE	36		88863090-51	
	0	3.5	18	45	BLUE	24	5 strands, D-Tach™	88863260-62	
	0	3.5	30	75	BLUE	36		88863090-61	
	2	5	30	75	BLUE	36		88863090-81	
	1	4	18	45	BLUE	24	5 strands, D-Tach™	88863260-72	
	1	4	30	75	BLUE	36		88863090-71	
GS-21 - GS-21 1/2 CIRCLE 37mm (Double armed) (Not to scale)	2	5	36	90	BLUE	36		88863146-81	
GS-25 1/2 CIRCLE 48mm (Not to scale)  GS-25	0	3.5	18	45	BLUE	24	5 strands, D-Tach™	88863261-62	
	0	3.5	30	75	BLUE	36		88863097-61	
	2	5	18	45	BLUE	24	5 strands, D-Tach™	88863261-82	
	1	4	18	45	BLUE	24	5 strands, D-Tach™	88863261-72	
	1	4	30	75	BLUE	36		88863097-71	
GS-27 - GS-27 1/2 CIRCLE 76mm (Double armed) (Not to scale)	0	3.5	30	75	BLUE	36		88863190-61	
GU-46 5/8 CIRCLE 27mm  GU-46	2-0	3	30	75	BLUE	36		88862768-51	
SK SKI 23mm  SK	2-0	3	48	120	BLUE	36		88863017-51	
	0	3.5	48	120	BLUE	36		88863017-61	

Surgipro™ II and Surgipro™ 7-0, 8-0; Sofsilik™ 8-0; Polysorb™, Biosyn™, Monosof™, Maxon™, Velosorb™ Fast sutures differ from USP and EP only in diameter. Please refer to IFU for more details.

© 2018 Medtronic. All rights reserved. Medtronic, Medtronic logo and Further, Together are trademarks of Medtronic.





™*Third party brands are trademarks of their respective owners.

All other brands are trademarks of a Medtronic company.

11/2018 US170542

TI-CRON™/SURGIDAC™

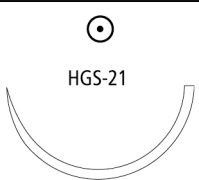
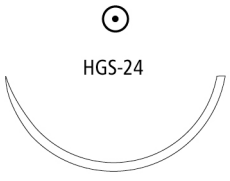
Coated and Uncoated Braided Polyester Non-Absorbable Sutures

HEAVY TAPER POINT									
Description		USP Size	EP Size	Length (in)	Length (cm)	Color	Units per box	Comments	Reorder code
HGS-23 1/2 CIRCLE 22mm	 <p>HGS-23</p>	2-0	3	18	45	BLUE	24	5 strands, D-Tach™	88863374-52
		0	3.5	18	45	BLUE	24	5 strands, D-Tach™	88863374-62
		1	4	30	75	BLUE	36		88863375-71
HGS-22 1/2 CIRCLE 27mm	 <p>HGS-22</p>	2-0	3	18	45	BLUE	24	5 strands, D-Tach™	88863379-52
		0	3.5	18	45	BLUE	24	5 strands, D-Tach™	88863379-62
		2	5	18	45	BLUE	24	5 strands	88863372-82
		1	4	18	45	BLUE	24	5 strands, D-Tach™	88863372-72
HGS-21 1/2 CIRCLE 37mm	 <p>HGS-21</p>	2	5	30	75	BLUE	36		88863113-81
		5	7	30	75	BLUE	36		88863111-79
		1	4	30	75	BLUE	36		88863113-71
HGS-24 1/2 CIRCLE 40mm	 <p>HGS-24</p>	2	5	30	75	BLUE	36		88863376-81
HGU-46 5/8 CIRCLE 27mm	 <p>HGU-46</p>	0	3.5	18	45	BLUE	24	5 strands, D-Tach™	88863386-62

Surgipro™ II and Surgipro™ 7-0, 8-0; Sofsilik™ 8-0; Polysorb™, Biosyn™, Monosof™, Maxon™, Velosorb™ Fast sutures differ from USP and EP only in diameter. Please refer to IFU for more details.

© 2018 Medtronic. All rights reserved. Medtronic, Medtronic logo and Further, Together are trademarks of Medtronic.



™*Third party brands are trademarks of their respective owners.

All other brands are trademarks of a Medtronic company.

11/2018 US170542

TI-CRON™/SURGIDAC™

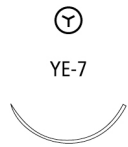
Coated and Uncoated Braided Polyester Non-Absorbable Sutures

PENETRATING TAPER									
Description	USP Size	EP Size	Length (in)	Length (cm)	Color	Units per box	Comments	Reorder code	
YE-7 3/8 CIRCLE 18mm 	4-0	1.5	30	75	BLUE	36	Cardiopoint™	88863107-31	
YE-7 - YE-7 3/8 CIRCLE 18mm (Double armed) 	4-0	1.5	30	75	BLUE	36	Cardiopoint™	88863182-31	
	3-0	2	30	75	BLUE	36	Cardiopoint™	88863182-41	
	3-0	2	30	75	BLUE	6	10 strands, Cardiopoint™	VCD-320	
	2-0	3	30	75	BLUE	36	Cardiopoint™	88863182-51	
	2-0	3	30	75	BLUE	36	Pledget 3x7mm FIRM	88863233-51	
	2-0	3	30	75	5BLUE & 5WHITE	6	10 strands, Cardiopoint™	88863211-56	
	2-0	3	30	75	5BLUE & 5WHITE	6	10 strands, Pledget 3x7mm FIRM	88863365-56	
	2-0	3	36	90	5BLUE & 5WHITE	6	10 strands, Cardiopoint™	88863052-56	
	2-0	3	36	90	BLUE	36	Cardiopoint™	88862631-51	
	2-0	3	36	90	5BLUE & 5WHITE	6	10 strands, Pledget 3x7mm FIRM, Cardiopoint™	8886265856	

Surgipro™ II and Surgipro™ 7-0, 8-0; Sofsilik™ 8-0; Polysorb™, Biosyn™, Monosof™, Maxon™, Velosorb™ Fast sutures differ from USP and EP only in diameter. Please refer to IFU for more details.

© 2018 Medtronic. All rights reserved. Medtronic, Medtronic logo and Further, Together are trademarks of Medtronic.



™*Third party brands are trademarks of their respective owners.

All other brands are trademarks of a Medtronic company.

11/2018 US170542

TI-CRON™/SURGIDAC™

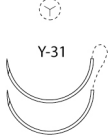
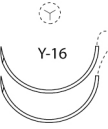
Coated and Uncoated Braided Polyester Non-Absorbable Sutures

PENETRATING TAPER											
Description	USP Size	EP Size	Length (in)	Length (cm)	Color	Units per box	Comments	Reorder code			
Y-31 - Y-31 1/2 CIRCLE 16mm (Double armed)		4-0	1.5	30	75	4BLUE & 4WHITE	6	8 strands, Pledget 3x3mm FIRM	88863218-36		
		4-0	1.5	36	90	BLUE	36	Cardioint™	88863160-31		
		3-0	2	30	75	WHITE	36	Cardioint™	88862880-41		
		3-0	2	36	90	BLUE	36	Cardioint™	88863160-41		
		2-0	3	30	75	5BLUE & 5WHITE	6	10 strands, Pledget 3x7mm FIRM	88863221-56		
		2-0	3	30	75	WHITE	36	Cardioint™	88862880-51		
		2-0	3	30	75	BLUE	36	Cardioint™	88863125-51		
		2-0	3	30	75	4BLUE & 4WHITE	6	8 strands, Pledget 3x3mm FIRM	88863218-56		
		2-0	3	30	75	5BLUE & 5WHITE	6	10 strands, Cardioint™	88862877-56		
		2-0	3	30	75	4BLUE & 4WHITE	6	8 strands, Pledget 3x7mm FIRM	88863219-56		
		2-0	3	30	75	2BLUE & 2WHITE	6	4 strands, Pledget 3 x 5mm FIRM, Cardioint™	VCD-110		
		2-0	3	30	75	4BLUE & 4WHITE	6	8 strands, Pledget 3x7mm SOFT	VCD-656		
		2-0	3	30	75	4BLUE & 4WHITE	6	8 strands, Oval Pledget 3x6mm FIRM, Cardioint™	VCD2031MFE		
		2-0	3	30	75	4BLUE & 4WHITE	6	8 strands, Oval Pledget 3x6mm SOFT, Cardioint™	VCD2031MSE		
		2-0	3	36	90	WHITE	36	Pledget 3x3mm FIRM	88862811-51		
		2-0	3	36	90	BLUE	36	Pledget 3x3mm FIRM	88863191-51		
		2-0	3	36	90	BLUE	36	Pledget 3x7mm FIRM	88863204-51		
		2-0	3	36	90	WHITE	36	Pledget 3x7mm FIRM	88862808-51		
		Y-16 - Y-16 1/2 CIRCLE 20mm (Double armed)		2-0	3	30	75	5BLUE & 5WHITE	6	10 strands, Cardioint™	88863241-56
				2-0	3	30	75	3BLUE & 3WHITE	6	6 strands, Pledget 3x7mm FIRM	88863303-56
2-0	3			36	90	BLUE	36	Cardioint™	88863157-51		
2-0	3			36	90	BLUE	36	Cardioint™	88863157-51		
Y-5 1/2 CIRCLE 26mm		3-0	2	30	75	BLUE	36	Cardioint™	88863088-41		
		2-0	3	30	75	BLUE	36	Cardioint™	88863088-51		

Surgipro™ II and Surgipro™ 7-0, 8-0; Sofsilik™ 8-0; Polysorb™, Biosyn™, Monosof™, Maxon™, Velosorb™ Fast sutures differ from USP and EP only in diameter. Please refer to IFU for more details.

© 2018 Medtronic. All rights reserved. Medtronic, Medtronic logo and Further, Together are trademarks of Medtronic.

™*Third party brands are trademarks of their respective owners.

All other brands are trademarks of a Medtronic company.

11/2018 US170542

TI-CRON™/SURGIDAC™

Coated and Uncoated Braided Polyester Non-Absorbable Sutures

PENETRATING TAPER								
Description	USP Size	EP Size	Length (in)	Length (cm)	Color	Units per box	Comments	Reorder code
Y-5 - Y-5 1/2 CIRCLE 26mm (Double armed)	4-0	1.5	36	90	BLUE	36		88863167-31
	3-0	2	36	90	BLUE	36	Cardiopoint™	88863167-41
	2-0	3	30	75	5BLUE & 5WHITE	6	10 strands, Cardiopoint™	88863222-56
	2-0	3	30	75	4BLUE & 4WHITE	6	8 strands, Pledget 3x7mm FIRM	88863213-56
	2-0	3	30	75	BLUE	36	Cardiopoint™	88863202-51
	2-0	3	30	75	WHITE	36	Cardiopoint™	88862855-51
	2-0	3	30	75	4BLUE & 4WHITE	6	8 strands, Pledget 3x7mm SOFT	VCD-256
	2-0	3	30	75	4BLUE & 4WHITE	6	8 strands, Pledget 3x3mm FIRM	88863203-56
	2-0	3	36	90	BLUE	36	Pledget 3x7mm FIRM	88863212-51
	2-0	3	36	90	WHITE	36	Pledget 3x7mm FIRM	88862840-51
	2-0	3	36	90	5BLUE & 5WHITE	6	10 strands, Pledget 3x7mm FIRM	88863290-56
	2-0	3	36	90	WHITE	36	Cardiopoint™	88862815-51
	2-0	3	36	90	5BLUE & 5WHITE	6	10 strands, Cardiopoint™	88862852-56
	2-0	3	36	90	BLUE	36	Cardiopoint™	88863167-51
	0	3.5	30	75	BLUE	36	Cardiopoint™	88863202-61
	0	3.5	30	75	4BLUE & 4WHITE	6	8 strands, Pledget 3x7mm FIRM	88863213-66
0	3.5	36	90	BLUE	36	Cardiopoint™	88863167-61	

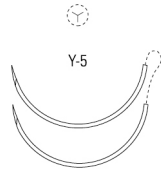

Surgipro™ II and Surgipro™ 7-0, 8-0; Sofsilik™ 8-0; Polysorb™, Biosyn™, Monosof™, Maxon™, Velosorb™ Fast sutures differ from USP and EP only in diameter. Please refer to IFU for more details.

© 2018 Medtronic. All rights reserved. Medtronic, Medtronic logo and Further, Together are trademarks of Medtronic.



™*Third party brands are trademarks of their respective owners.

All other brands are trademarks of a Medtronic company.

11/2018 US170542

TI-CRON™/SURGIDAC™

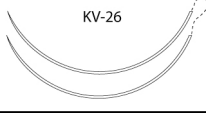
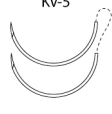
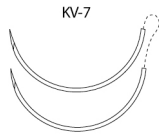
Coated and Uncoated Braided Polyester Non-Absorbable Sutures

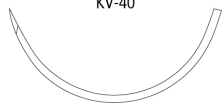
TAPERCUTTING								
Description	USP Size	EP Size	Length (in)	Length (cm)	Color	Units per box	Comments	Reorder code
KV-15 - KV-15 3/8 CIRCLE 17mm (Double armed) 	2-0	3	30	75	BLUE	6	4 strands, Surgalloy™	88863131-56
KV-26 - KV-26 3/8 CIRCLE 26mm (Double armed) 	2-0	3	36	90	5BLUE & 5WHITE	6	10 strands, Pledget 3x7mm FIRM, Surgalloy™	88863275-56
KV-5 - KV-5 1/2 CIRCLE 17mm (Double armed) 	4-0	1.5	36	90	BLUE	36	Surgalloy™	88863159-31
	3-0	2	36	90	BLUE	36	Surgalloy™	88863159-41
	2-0	3	30	75	4BLUE & 4WHITE	6	8 strands, Pledget 3x3mm FIRM, Surgalloy™	88863236-56
	2-0	3	30	75	4BLUE & 4WHITE	6	8 strands, Pledget 3x3mm FIRM, Surgalloy™	88863235-56
	2-0	3	30	75	5BLUE & 5WHITE	6	10 strands, Surgalloy™	88862879-56
	2-0	3	36	90	BLUE	36	Pledget 3x3mm FIRM, Surgalloy™	88863193-51
	2-0	3	36	90	BLUE	36	Surgalloy™	88863159-51
KV-7 - KV-7 1/2 CIRCLE 26mm (Double armed) 	2-0	3	30	75	BLUE	36	Surgalloy™	88863319-51
	2-0	3	30	75	4BLUE & 4WHITE	6	8 strands, Pledget 3x3mm FIRM, Surgalloy™	88863240-56
	2-0	3	30	75	5BLUE & 5WHITE	6	10 strands, Pledget 3x7mm FIRM, Surgalloy™	88863228-56
	2-0	3	36	90	BLUE	36	Pledget 3x7mm FIRM, Surgalloy™	88863239-51
	2-0	3	36	90	BLUE	36	Surgalloy™	88863168-51
KV-34 1/2 CIRCLE 37mm 	0	3.5	30	75	BLUE	36		88863119-61
KV-37 1/2 CIRCLE 40mm 	0	3.5	30	75	BLUE	36		88863092-61
	2	5	30	75	BLUE	12	5 strands	88863147-83
	5	7	30	75	BLUE	12	5 strands	88863147-89
	1	4	30	75	BLUE	36		88863092-71
KV-40 1/2 CIRCLE 48mm (Not to scale) 	5	7	30	75	BLUE	12	4 strands	88862818-89

Surgipro™ II and Surgipro™ 7-0, 8-0; Sofsilik™ 8-0; Polysorb™, Biosyn™, Monosof™, Maxon™, Velosorb™ Fast sutures differ from USP and EP only in diameter. Please refer to IFU for more details.

© 2018 Medtronic. All rights reserved. Medtronic, Medtronic logo and Further, Together are trademarks of Medtronic.

™*Third party brands are trademarks of their respective owners.



All other brands are trademarks of a Medtronic company.

11/2018 US170542

TI-CRON™/SURGIDAC™

Coated and Uncoated Braided Polyester Non-Absorbable Sutures

DIAMOND POINT									
Description	USP Size	EP Size	Length (in)	Length (cm)	Color	Units per box	Comments	Reorder code	
KV-30 1/2 CIRCLE 27mm 	0	3.5	30	75	BLUE	36		88863117-61	
	2	5	30	75	2BLUE & 2WHITE	12	4 strands	88862962-83	
	1	4	30	75	BLUE	36		88863117-71	

PREMIUM SPATULA									
Description	USP Size	EP Size	Length (in)	Length (cm)	Color	Units per box	Comments	Reorder code	
SS-14 - SS-14 1/4 CIRCLE 8.6mm (Double armed) 	6-0	0.7	18	45	WHITE	12	Surgalloy™	D-1722K	
	5-0	1	18	45	WHITE	12	Surgalloy™	D-1760K	
SS-24 - SS-24 1/4 CIRCLE 8.6mm (Double armed) 	6-0	0.7	18	45	WHITE	12	Surgalloy™	CD-3113K	
	5-0	1	18	45	WHITE	12	Surgalloy™	CD-3123K	
	5-0	1	18	45	WHITE	12	Surgalloy™	D-1764K	
	4-0	1.5	18	45	WHITE	12	Surgalloy™	D-1763K	
SS-2 - SS-2 1/2 CIRCLE 8.6mm (Double armed) 	5-0	1	18	45	WHITE	12	Surgalloy™	D-1780K	
	5-0	1	18	45	WHITE	12	Surgalloy™	CD-0423K	
	4-0	1.5	18	45	WHITE	12	Surgalloy™	D-1779K	

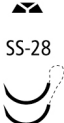
INVERTED PREMIUM SPATULA									
Description	USP Size	EP Size	Length (in)	Length (cm)	Color	Units per box	Comments	Reorder code	
SS-29 - SS-29 1/4 CIRCLE 7.4mm (Double armed) 	4-0	1.5	18	45	WHITE	12	Surgalloy™	D-1879K	
SS-28 - SS-28 3/8 CIRCLE 7.4mm (Double armed) 	6-0	0.7	18	45	WHITE	12	Surgalloy™	D-1683K	

Surgipro™ II and Surgipro™ 7-0, 8-0; Sofsilik™ 8-0; Polysorb™, Biosyn™, Monosof™, Maxon™, Velosorb™ Fast sutures differ from USP and EP only in diameter. Please refer to IFU for more details.

© 2018 Medtronic. All rights reserved. Medtronic, Medtronic logo and Further, Together are trademarks of Medtronic.

™*Third party brands are trademarks of their respective owners.

All other brands are trademarks of a Medtronic company.

11/2018 US170542

TI-CRON™/SURGIDAC™

Coated and Uncoated Braided Polyester Non-Absorbable Sutures

Reorder Code	Page	Reorder Code	Page	Reorder Code	Page
88862627-41	146	88863008-31	141	8886306261	145
88862631-51	153	88863008-41	141	88863065-51	142
8886263656	146	88863008-51	141	88863065-61	142
8886265856	153	88863011-51	141	88863069-41	142
88862768-51	151	88863012-61	142	88863070-51	142
88862775-21	146	88863015-61	150	88863082-51	150
88862775-31	146	88863017-51	151	88863082-61	150
88862775-41	146	88863017-61	151	88863083-56	147
88862801-21	146	88863023-51	142	88863084-46	147
88862808-51	154	8886302361	142	88863084-56	147
88862811-51	154	88863023-71	142	88863086-56	147
88862815-51	155	88863026-71	143	88863087-31	147
88862818-89	156	88863026-81	143	88863087-41	147
88862839-51	148	88863027-79	143	88863087-51	147
88862840-51	155	88863028-71	143	88863088-41	154
88862851-56	154	88863028-81	143	88863088-51	154
88862852-56	155	88863033-52	148	88863090-51	151
88862854-33	144	88863035-41	149	88863090-61	151
88862855-51	155	88863035-51	149	88863090-71	151
88862862-34	144	88863037-56	149	88863090-81	151
88862877-56	154	88863040-56	149	88863091-56	147
88862879-56	156	88863045-21	142	88863092-61	156
88862880-41	154	88863046-31	142	88863092-71	156
88862880-51	154	88863047-31	142	88863093-51	150
88862914-51	149	88863047-41	142	88863093-61	150
88862914-61	149	88863048-51	142	88863097-61	151
88862947-53	145	88863050-41	142	88863097-71	151
88862953-51	149	88863050-51	142	88863103-71	150
88862962-83	157	88863050-61	142	88863104-21	146
88862978-51	148	88863052-56	153	88863106-31	146
88862981-56	149	88863054-51	142	88863107-31	153
88863001-41	141	88863054-61	142	88863109-43	144
88863001-62	141	88863054-71	142	88863111-79	152
88863001-72	141	88863054-81	142	88863113-71	152
88863002-62	141	88863055-41	142	88863113-81	152
88863003-32	141	88863056-89	142	88863117-61	157
88863003-42	141	88863059-53	144	88863117-71	157
88863003-52	141	88863062-41	145	88863119-61	156
88863008-21	141	88863062-51	145	88863125-51	154

Surgipro™ II and Surgipro™ 7-0, 8-0; Sofsilik™ 8-0; Polysorb™, Biosyn™, Monosof™, Maxon™, Velosorb™ Fast sutures differ from USP and EP only in diameter.

Please refer to IFU for more details.

© 2018 Medtronic. All rights reserved. Medtronic, Medtronic logo and Further, Together are trademarks of Medtronic.

™*Third party brands are trademarks of their respective owners.

All other brands are trademarks of a Medtronic company.

11/2018 US170542

TI-CRON™/SURGIDAC™

Coated and Uncoated Braided Polyester Non-Absorbable Sutures

Reorder Code	Page	Reorder Code	Page	Reorder Code	Page
88863127-79	145	88863190-61	151	88863256-41	149
88863128-79	142	88863191-51	154	88863256-51	149
88863128-82	142	88863193-51	156	88863256-61	149
88863129-51	150	88863202-51	155	88863257-62	148
88863131-56	156	88863202-61	155	88863258-32	150
88863139-21	147	88863203-56	155	88863258-42	150
88863146-81	151	88863204-51	154	88863258-52	150
88863147-83	156	88863205-41	150	88863259-52	150
88863147-89	156	88863205-51	150	88863259-62	150
88863154-09	143	88863205-61	150	88863260-52	151
88863155-81	143	88863211-56	153	88863260-62	151
88863157-51	154	88863212-51	155	88863260-72	151
88863159-31	156	88863213-56	155	88863261-62	151
88863159-41	156	88863213-66	155	88863261-72	151
88863159-51	156	88863218-36	154	88863261-82	151
88863160-31	154	88863218-56	154	88863267-42	147
88863160-41	154	88863219-56	154	88863269-56	147
88863160-51	154	88863220-56	149	88863271-21	147
88863163-51	145	88863221-56	154	88863271-31	147
88863163-61	145	88863222-56	155	88863271-41	147
88863163-71	145	88863226-21	147	88863273-56	147
88863165-51	145	88863226-31	147	88863274-51	150
88863167-31	155	88863226-41	147	88863274-61	150
88863167-41	155	88863227-41	148	88863275-56	156
88863167-51	155	88863227-51	148	88863277-56	148
88863167-61	155	88863228-56	156	88863280-11	146
88863168-51	156	88863229-31	146	88863280-21	146
88863182-31	153	88863229-41	146	88863280-31	146
88863182-41	153	88863230-56	146	88863280-41	146
88863182-51	153	88863233-51	153	88863288-01	146
88863185-31	148	88863235-56	156	88863290-56	155
88863185-41	148	88863236-56	156	88863295-41	147
88863185-51	148	88863239-51	156	88863297-21	147
88863185-61	148	88863240-56	156	88863298-21	147
88863185-71	148	88863241-56	154	88863303-56	154
88863186-21	147	88863249-31	147	88863306-56	149
88863186-31	147	88863251-51	150	88863307-56	149
88863186-41	147	88863255-56	154	88863309-51	143
88863186-51	147	88863256-31	149	88863309-61	143

Surgipro™ II and Surgipro™ 7-0, 8-0; Sofsilik™ 8-0; Polysorb™, Biosyn™, Monosof™, Maxon™, Velosorb™ Fast sutures differ from USP and EP only in diameter.

Please refer to IFU for more details.

© 2018 Medtronic. All rights reserved. Medtronic, Medtronic logo and Further, Together are trademarks of Medtronic.

™*Third party brands are trademarks of their respective owners.

All other brands are trademarks of a Medtronic company.

11/2018 US170542

TI-CRON™/SURGIDAC™

Coated and Uncoated Braided Polyester Non-Absorbable Sutures

Reorder Code	Page	Reorder Code	Page	Reorder Code	Page
88863309-71	143	88863393-61	150	VCD2202	154
88863314-21	146	88863395-51	143	VCD2203	154
88863314-31	146	88863395-61	143	VCD2346	148
88863319-51	156	88863395-71	143	VCD-256	155
88863323-56	148	88863395-81	143	VCD-320	153
88863324-56	149	CD-0423K	157	VCD-346	149
8886332466	149	CD-3113K	157	VCD-375	148
88863324-66	149	CD-3123K	157	VCD-656	154
88863336-41	149	CD-496	142	VCD8011G	146
88863336-51	149	D-1683K	157		
88863344-56	148	D-1722K	157		
88863348-31	148	D-1760K	157		
88863348-51	148	D-1763K	157		
88863353-56	148	D-1764K	157		
88863356-56	149	D-1779K	157		
88863365-56	153	D-1780K	157		
88863369-31	148	D-1879K	157		
88863369-41	148	SCD-2864G	144		
88863369-51	148	SCD-3049G	144		
8886337041	148	SCD-3058G	144		
88863370-51	148	SCD-3059G	144		
88863372-72	152	VCD-110	154		
88863372-82	152	VCD2030556M	149		
88863374-52	152	FE			
88863374-62	152	VCD2030556M	149		
88863375-71	152	SE			
88863376-81	152	VCD20305FE	149		
88863379-52	152	VCD20305MFE	149		
88863379-62	152	VCD20305MSE	149		
88863380-42	141	VCD20305SE	149		
88863380-52	141	VCD20316FE	148		
88863380-62	141	VCD20316MFE	148		
88863380-72	141	VCD20316MSE	148		
88863380-82	141	VCD20316SE	148		
88863381-09	141	VCD2031MFE	154		
88863381-89	141	VCD2031MSE	154		
88863385-56	148	VCD20331FE	147		
88863386-62	152	VCD20331SE	147		
88863393-51	150	VCD2036305F	149		
		E			

Surgipro™ II and Surgipro™ 7-0, 8-0; Sofsilik™ 8-0; Polysorb™, Biosyn™, Monosof™, Maxon™, Velosorb™ Fast sutures differ from USP and EP only in diameter. Please refer to IFU for more details.

© 2018 Medtronic. All rights reserved. Medtronic, Medtronic logo and Further, Together are trademarks of Medtronic.

™*Third party brands are trademarks of their respective owners.

All other brands are trademarks of a Medtronic company.

11/2018 US170542





VASCUFIL™

Monofilament Polybutester Non-Absorbable Sutures with Polytribolate™ Absorbable Coating

Description	Vascufil™ monofilament polybutester sutures are nonabsorbable, sterile, surgical sutures composed of a copolymer of butylene terephthalate and polytetramethylene ether glycol. The suture is coated with Polytribolate™, an absorbable polymer of e-caprolactone / glycolide / poloxamer 188.
Indications	Vascufil™ polybutester sutures are indicated for use in general soft tissue approximation and/or ligation, including use in cardiovascular and ophthalmic surgery, but not in microsurgery and neural tissue.
Actions	Vascufil™ sutures elicit a minimal acute inflammatory reaction in tissues, which is followed by gradual encapsulation of the suture by fibrous connective tissue.
Tensile Strength	Vascufil™ sutures are not absorbed, nor is any significant change in strength retention known to occur in vivo. Excretion of the absorbable coating is essentially complete within thirty days.
Sterilization	Gamma irradiation.
Packaging	Vascufil™ monofilament sutures are available dyed with Copper Phthalocyanine Blue in U.S.P. sizes 2-0 (3 Metric) through 7-0 (0.5 Metric). The sutures are supplied sterile, in pre-cut lengths affixed to various needle types, using permanent needle attachment techniques. Please refer to the individual package IFUs for complete instructions, indications, contraindications, warnings and precautions.

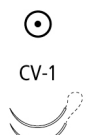
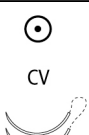
VASCUFIL™

Monofilament Polybutester Non-Absorbable Sutures with Polytribolate™ Absorbable Coating

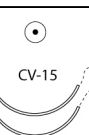
TAPER POINT									
Description		USP Size	EP Size	Length (in)	Length (cm)	Color	Units per box	Comments	Reorder code
MV-175-8 - MV-175-8 3/8 CIRCLE 8mm (Double armed)	 MV-175-8	7-0	0.5	24	60	BLUE	36	Surgalloy™	88864794-01V
		7-0	0.5	24	60	BLUE	12	4 strands, Surgalloy™	88864788-05V
		7-0	0.5	24	60	BLUE	12	2 strands, Surgalloy™	88864795-05V
CV-1 - CV-1 3/8 CIRCLE 9mm (Double armed)	 CV-1	7-0	0.5	18	45	BLUE	36	Surgalloy™	88864703-01V
		7-0	0.5	24	60	BLUE	12	4 strands, Surgalloy™	88864702-05V
		7-0	0.5	24	60	BLUE	36	Surgalloy™	88864705-01V
		7-0	0.5	30	75	BLUE	36	Surgalloy™	88864704-01V
		7-0	0.5	30	75	BLUE	12	4 strands, Surgalloy™	88864701-05V
		6-0	0.7	18	45	BLUE	36	Surgalloy™	88864703-11V
		6-0	0.7	24	60	BLUE	36	Surgalloy™	88864705-11V
CV - CV 3/8 CIRCLE 11mm (Double armed)	 CV	6-0	0.7	30	75	BLUE	36	Surgalloy™	88864756-11V
CV-11 3/8 CIRCLE 13mm	 CV-11	5-0	1	30	75	BLUE	36	Surgalloy™	88864722-21V
CV-11 - CV-11 3/8 CIRCLE 13mm (Double armed)	 CV-11	6-0	0.7	18	45	BLUE	36	Surgalloy™	88864707-11V
		6-0	0.7	24	60	BLUE	36	Surgalloy™	88864709-11V
		6-0	0.7	30	75	BLUE	36	Surgalloy™	88864710-11V
		5-0	1	24	60	BLUE	36	Surgalloy™	88864709-21V
		5-0	1	30	75	BLUE	36	Surgalloy™	88864710-21V
CV-15 3/8 CIRCLE 17mm	 CV-15	5-0	1	30	75	BLUE	36	Surgalloy™	88864739-21V
		4-0	1.5	30	75	BLUE	36	Surgalloy™	88864739-31V
CV-15 - CV-15 3/8 CIRCLE 17mm (Double armed)	 CV-15	5-0	1	36	90	BLUE	36	Surgalloy™	88864716-21V
		4-0	1.5	36	90	BLUE	36	Surgalloy™	88864716-31V

Surgipro™ II and Surgipro™ 7-0, 8-0; Sofsilik™ 8-0; Polysorb™, Biosyn™, Monosof™, Maxon™, Velosorb™ Fast sutures differ from USP and EP only in diameter. Please refer to IFU for more details.

© 2018 Medtronic. All rights reserved. Medtronic, Medtronic logo and Further, Together are trademarks of Medtronic.



™*Third party brands are trademarks of their respective owners.

All other brands are trademarks of a Medtronic company.

11/2018 US170542

VASCUFIL™

Monofilament Polybutester Non-Absorbable Sutures with Polytribolate™ Absorbable Coating

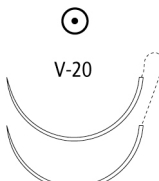
TAPER POINT									
Description		USP Size	EP Size	Length (in)	Length (cm)	Color	Units per box	Comments	Reorder code
CV-22 - CV-22 1/2 CIRCLE 13mm (Double armed)	 CV-22	6-0	0.7	30	75	BLUE	12	4 strands, Surgalloy™	88864742-15V
		6-0	0.7	30	75	BLUE	36	Surgalloy™	88864741-11V
		5-0	1	30	75	BLUE	36	Surgalloy™	88864741-21V
CV-23 - CV-23 1/2 CIRCLE 17mm (Double armed)	 CV-23	5-0	1	36	90	BLUE	36	Surgalloy™	88864719-21V
		4-0	1.5	36	90	BLUE	36	Surgalloy™	88864719-31V
V-20 - V-20 1/2 CIRCLE 26mm (Double armed)	 V-20	4-0	1.5	36	90	BLUE	36	Surgalloy™	88864750-31V
		3-0	2	36	90	BLUE	36	Surgalloy™	88864750-41V
		2-0	3	36	90	BLUE	36	Surgalloy™	88864750-51V

TAPERCUTTING									
Description		USP Size	EP Size	Length (in)	Length (cm)	Color	Units per box	Comments	Reorder code
KV-1 - KV-1 3/8 CIRCLE 9mm (Double armed)	 KV-1	6-0	0.7	24	60	BLUE	36	Surgalloy™	88864714-11V
KV-11 - KV-11 3/8 CIRCLE 13mm (Double armed)	 KV-11	6-0	0.7	30	75	BLUE	36	Surgalloy™	88864734-11V
		5-0	1	30	75	BLUE	36	Surgalloy™	88864734-21V
KV-7 1/2 CIRCLE 26mm	 KV-7	2-0	3	36	90	BLUE	36	Surgalloy™	88864730-51V
KV-7 - KV-7 1/2 CIRCLE 26mm (Double armed)	 KV-7	4-0	1.5	36	90	BLUE	36	Surgalloy™	88864731-31V
		3-0	2	36	90	BLUE	36	Surgalloy™	88864731-41V
		2-0	3	36	90	BLUE	36	Surgalloy™	88864731-51V

Surgipro™ II and Surgipro™ 7-0, 8-0; Sofsilik™ 8-0; Polysorb™, Biosyn™, Monosof™, Maxon™, Velosorb™ Fast sutures differ from USP and EP only in diameter. Please refer to IFU for more details.

© 2018 Medtronic. All rights reserved. Medtronic, Medtronic logo and Further, Together are trademarks of Medtronic.

™*Third party brands are trademarks of their respective owners.

All other brands are trademarks of a Medtronic company.

11/2018 US170542

VASCUFIL™

Monofilament Polybutester Non-Absorbable Sutures with Polytribolate™ Absorbable Coating

Reorder Code	Page	Reorder Code	Page	Reorder Code	Page
<u>88864701-05V</u>	163				
<u>88864702-05V</u>	163				
<u>88864703-01V</u>	163				
<u>88864703-11V</u>	163				
<u>88864704-01V</u>	163				
<u>88864704-11V</u>	163				
<u>88864705-01V</u>	163				
<u>88864705-11V</u>	163				
<u>88864707-11V</u>	163				
<u>88864709-11V</u>	163				
<u>88864709-21V</u>	163				
<u>88864710-11V</u>	163				
<u>88864710-21V</u>	163				
<u>88864711-21V</u>	163				
<u>88864714-11V</u>	164				
<u>88864716-21V</u>	163				
<u>88864716-31V</u>	163				
<u>88864719-21V</u>	164				
<u>88864719-31V</u>	164				
<u>88864722-21V</u>	163				
<u>88864730-51V</u>	164				
<u>88864731-31V</u>	164				
<u>88864731-41V</u>	164				
<u>88864731-51V</u>	164				
<u>88864734-11V</u>	164				
<u>88864734-21V</u>	164				
<u>88864739-21V</u>	163				
<u>88864739-31V</u>	163				
<u>88864741-11V</u>	164				
<u>88864741-21V</u>	164				
<u>88864742-15V</u>	164				
<u>88864750-31V</u>	164				
<u>88864750-41V</u>	164				
<u>88864750-51V</u>	164				
<u>88864756-11V</u>	163				
<u>88864788-05V</u>	163				
<u>88864794-01V</u>	163				
<u>88864795-05V</u>	163				

Surgipro™ II and Surgipro™ 7-0, 8-0; Sofsilik™ 8-0; Polysorb™, Biosyn™, Monosof™, Maxon™, Velosorb™ Fast sutures differ from USP and EP only in diameter. Please refer to IFU for more details.

© 2018 Medtronic. All rights reserved. Medtronic, Medtronic logo and Further, Together are trademarks of Medtronic.

™*Third party brands are trademarks of their respective owners.

All other brands are trademarks of a Medtronic company.

11/2018 US170542

FLEXON™

Temporary Cardiac Pacing Leads

Description	Flexon™ temporary cardiac pacing lead is a stainless steel twisted, multistrand wire coated with orange or white PTFE poly (tetrafluoroproethylene) or clear FEP poly (tetrafluoroethylene-co-hexafluoropropylene).
Indications	Flexon™ temporary cardiac pacing lead is indicated for use in temporary atrial and ventricular pacing and sensing during and after cardiac surgery.
Actions	Flexon™ temporary cardiac pacing lead elicits minimal acute inflammatory reaction in tissues and is not absorbed.
Tensile Strength	Permanent.
Sterilization	Ethylene oxide.
Packaging	Flexon™ temporary cardiac pacing lead are available coated with orange or white PTFE or clear FEP in size 0 (3.5 metric), size 2-0 (3 metric) and 3-0 (2 metric). Flexon™ temporary cardiac pacing lead is supplied sterile affixed to various types of needles, including Breakaway™ needles. Please refer to the individual package IFUs for complete instructions, indications, contraindications, warnings and precautions.

Temporary Cardiac Pacing Leads

TAPER POINT									
Description	USP Size	EP Size	Length (in)	Length (cm)	Color	Units per box	Comments	Reorder code	
CV-23 - SC 1/2 CIRCLE 17mm (Double armed) (Not to scale)	3-0	2	24	60	UNDYED	12		88862591-43	
CV-23 - SC-2 1/2 CIRCLE 17mm (Double armed) (Not to scale)	3-0	2	24	60	UNDYED	12		88862592-43	
CV-23 - SC-6 1/2 CIRCLE 17mm (Double armed) (Not to scale)	3-0	2	24	60	UNDYED	12		88862586-43	
CV-24 - SC-2 1/2 CIRCLE 20mm (Double armed) (Not to scale)	0	3.5	24	60	UNDYED	12		88862593-63	
V-20 - SC-2 1/2 CIRCLE 26mm (Double armed) (Not to scale)	0	3.5	24	60	UNDYED	12		88862597-63	
V-20 - SC-6 1/2 CIRCLE 26mm (Double armed) (Not to scale)	2-0	3	24	60	WHITE	12		88862615-53	
	2-0	3	24	60	ORANGE & WHITE	12	2 strands	88862623-53	
	2-0	3	24	60	ORANGE	12		88862617-53	
	0	3.5	24	60	UNDYED	12		88862589-63	

Surgipro™ II and Surgipro™ 7-0, 8-0; Sofsilik™ 8-0; Polysorb™, Biosyn™, Monosof™, Maxon™, Velosorb™ Fast sutures differ from USP and EP only in diameter. Please refer to IFU for more details.

© 2018 Medtronic. All rights reserved. Medtronic, Medtronic logo and Further, Together are trademarks of Medtronic.

™*Third party brands are trademarks of their respective owners.

All other brands are trademarks of a Medtronic company.

11/2018 US170542

FLEXON™

Temporary Cardiac Pacing Leads

Reorder Code	Page	Reorder Code	Page	Reorder Code	Page
<u>88862586-43</u>	169				
<u>88862589-63</u>	169				
<u>88862591-43</u>	169				
<u>88862592-43</u>	169				
<u>88862593-63</u>	169				
<u>88862597-63</u>	169				
<u>88862615-53</u>	169				
<u>88862617-53</u>	169				
<u>88862623-53</u>	169				

Surgipro™ II and Surgipro™ 7-0, 8-0; Sofsilik™ 8-0; Polysorb™, Biosyn™, Monosof™, Maxon™, Velosorb™ Fast sutures differ from USP and EP only in diameter. Please refer to IFU for more details.

© 2018 Medtronic. All rights reserved. Medtronic, Medtronic logo and Further, Together are trademarks of Medtronic.

™*Third party brands are trademarks of their respective owners.

All other brands are trademarks of a Medtronic company.

11/2018 US170542

STEEL

Stainless Steel Monofilament Non-Absorbable Sutures

Description	Stainless monofilament steel sutures are composed of 316L stainless steel conforming to ASTM Standard F138 Grade 2 "Stainless steel bar and wire for surgical implants."
Indications	Steel sutures are indicated for use in orthopedic and cardiovascular (sternal closure) procedures.
Actions	Steel sutures elicit a minimal acute inflammatory reaction in tissue, and are not absorbed.
Tensile Strength	Permanent.
Sterilization	Ethylene oxide or gamma irradiation.
Packaging	Steel sutures are available in monofilament strands in size 7(9 Metric) through 3-0 (2 Metric). The sutures are supplied sterile, in pre-cut lengths affixed to various types of needles using permanent needle attachment technique. Please refer to the individual package IFUs for complete instructions, indications, contraindications, warnings and precautions

STEEL

Stainless Steel Monofilament Non-Absorbable Sutures

NON NEEDLED - PRE-CUT								
Description	USP Size	EP Size	Length (in)	Length (cm)	Color	Units per box	Comments	Reorder code
PRE-CUT	3-0	2	18	45	UNDYED	12	12 strands	88862407-43
	2-0	3	18	45	UNDYED	12	12 strands	88862407-53
	0	3.5	18	45	UNDYED	12	12 strands	88862407-63
	2	5	18	45	UNDYED	12	6 strands	88862408-83
	7	9	18	45	UNDYED	12	12 strands	88862407-49
	1	4	18	45	UNDYED	12	6 strands	88862408-73

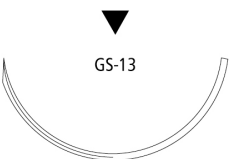
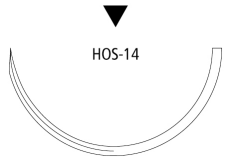
REVERSE CUTTING								
Description	USP Size	EP Size	Length (in)	Length (cm)	Color	Units per box	Comments	Reorder code
GS-12 1/2 CIRCLE 40mm 	2	5	18	45	UNDYED	12	5 strands	88862413-83
GS-13 ROTO 1/2 CIRCLE 48mm (Not to scale) 	2	5	18	45	UNDYED	12	2 strands	88862420-83
	3&4	6	18	45	UNDYED	12	2 strands	88862420-09
HOS-14 1/2 CIRCLE 55mm (Not to scale) 	5	7	18	45	UNDYED	12	4 strands	88862410-89
	5	7	30	75	UNDYED	12	2 strands	88862424-89
	5	7	30	75	UNDYED	12		88862412-89
	6	8	18	45	UNDYED	12	4 strands	88862410-69

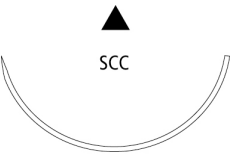
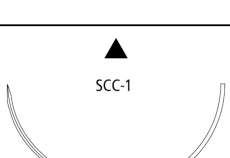
CONVENTIONAL CUTTING								
Description	USP Size	EP Size	Length (in)	Length (cm)	Color	Units per box	Comments	Reorder code
SCC 1/2 CIRCLE 48mm (Not to scale) 	5	7	18	45	UNDYED	12	2 strands	88862222-89
	5	7	18	45	UNDYED	12	6 strands	88862226-89
	5	7	18	45	UNDYED	12	4 strands	88862224-89
	6	8	18	45	UNDYED	12	4 strands	88862224-69
	6	8	18	45	UNDYED	12	2 strands	88862222-69
	6	8	18	45	UNDYED	12	6 strands	88862226-69
	7	9	18	45	UNDYED	12	4 strands	88862224-49
SCC-1 1/2 CIRCLE 60mm (Not to scale) 	3&4	6	18	45	UNDYED	12	4 strands	88862224-09
	5	7	30	75	UNDYED	12	2 strands	88862228-89

Surgipro™ II and Surgipro™ 7-0, 8-0; Sofsilik™ 8-0; Polysorb™, Biosyn™, Monosof™, Maxon™, Velosorb™ Fast sutures differ from USP and EP only in diameter. Please refer to IFU for more details.

© 2018 Medtronic. All rights reserved. Medtronic, Medtronic logo and Further, Together are trademarks of Medtronic.



™*Third party brands are trademarks of their respective owners.

All other brands are trademarks of a Medtronic company.

11/2018 US170542

STEEL

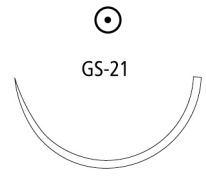
Stainless Steel Monofilament Non-Absorbable Sutures

TAPER POINT									
Description	USP Size	EP Size	Length (in)	Length (cm)	Color	Units per box	Comments	Reorder code	
GS-21 1/2 CIRCLE 37mm 	2-0	3	18	45	UNDYED	12	5 strands	88862345-53	
GS-25 1/2 CIRCLE 48mm (Not to scale) 	2-0	3	24	60	UNDYED	12	5 strands	88862348-53	

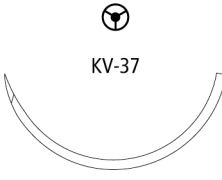
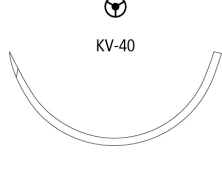
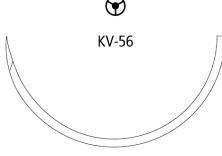
TAPERCUTTING									
Description	USP Size	EP Size	Length (in)	Length (cm)	Color	Units per box	Comments	Reorder code	
KV-37 1/2 CIRCLE 40mm 	2	5	18	45	UNDYED	12	5 strands	88862382-83	
KV-40 1/2 CIRCLE 48mm (Not to scale) 	5	7	18	45	UNDYED	12	4 strands	88862393-89	
	5	7	18	45	UNDYED	12	ROTOGRIP, 4 strands	88862414-89	
	5	7	18	45	UNDYED	12	2 strands	88862376-89	
	6	8	18	45	UNDYED	12	2 strands	88862392-69	
	6	8	18	45	UNDYED	12	4 strands	88862393-69	
	7	9	18	45	UNDYED	12	2 strands	88862392-49	
KV-56 1/2 CIRCLE 60mm (Not to scale) 	3&4	6	18	45	UNDYED	12	5 strands	88862466-25	
	5	7	30	75	UNDYED	12	5 strands	88862396-89	

Surgipro™ II and Surgipro™ 7-0, 8-0; Sofsilik™ 8-0; Polysorb™, Biosyn™, Monosof™, Maxon™, Velosorb™ Fast sutures differ from USP and EP only in diameter. Please refer to IFU for more details.

© 2018 Medtronic. All rights reserved. Medtronic, Medtronic logo and Further, Together are trademarks of Medtronic.



™*Third party brands are trademarks of their respective owners.

All other brands are trademarks of a Medtronic company.

11/2018 US170542

STEEL

Stainless Steel Monofilament Non-Absorbable Sutures

BLUNT TAPER POINT									
Description	USP Size	EP Size	Length (in)	Length (cm)	Color	Units per box	Comments	Reorder code	
BGS-26 1/2 CIRCLE 44mm (Not to scale)	5	7	30	75	UNDYED	12	2 strands, ProtectPoint™	88862497-89	
BGS-29 1/2 CIRCLE 63mm (Not to scale)	5	7	18	45	UNDYED	12	5 strands	88862495-89	

BLUNT POINT									
Description	USP Size	EP Size	Length (in)	Length (cm)	Color	Units per box	Comments	Reorder code	
BP-27 1/2 CIRCLE 64mm (Not to scale)	5	7	30	75	UNDYED	12	2 strands, ProtectPoint™	88862494-89	

Surgipro™ II and Surgipro™ 7-0, 8-0; Sofsilik™ 8-0; Polysorb™, Biosyn™, Monosof™, Maxon™, Velosorb™ Fast sutures differ from USP and EP only in diameter. Please refer to IFU for more details.

© 2018 Medtronic. All rights reserved. Medtronic, Medtronic logo and Further, Together are trademarks of Medtronic.

™*Third party brands are trademarks of their respective owners.

All other brands are trademarks of a Medtronic company.

11/2018 US170542

STEEL

Stainless Steel Monofilament Non-Absorbable Sutures

Reorder Code	Page	Reorder Code	Page	Reorder Code	Page
<u>88862222-69</u>	<u>173</u>				
<u>88862222-89</u>	<u>173</u>				
<u>88862224-09</u>	<u>173</u>				
<u>88862224-49</u>	<u>173</u>				
<u>88862224-69</u>	<u>173</u>				
<u>88862224-89</u>	<u>173</u>				
<u>88862226-69</u>	<u>173</u>				
<u>88862226-89</u>	<u>173</u>				
<u>88862228-89</u>	<u>173</u>				
<u>88862345-53</u>	<u>174</u>				
<u>88862348-53</u>	<u>174</u>				
<u>88862376-89</u>	<u>174</u>				
<u>88862382-83</u>	<u>174</u>				
<u>88862392-49</u>	<u>174</u>				
<u>88862392-69</u>	<u>174</u>				
<u>88862393-69</u>	<u>174</u>				
<u>88862393-89</u>	<u>174</u>				
<u>88862396-89</u>	<u>174</u>				
<u>88862407-43</u>	<u>173</u>				
<u>88862407-49</u>	<u>173</u>				
<u>88862407-53</u>	<u>173</u>				
<u>88862407-63</u>	<u>173</u>				
<u>88862408-73</u>	<u>173</u>				
<u>88862408-83</u>	<u>173</u>				
<u>88862410-69</u>	<u>173</u>				
<u>88862410-89</u>	<u>173</u>				
<u>88862412-89</u>	<u>173</u>				
<u>88862413-83</u>	<u>173</u>				
<u>88862414-89</u>	<u>174</u>				
<u>88862420-09</u>	<u>173</u>				
<u>88862420-83</u>	<u>173</u>				
<u>88862424-89</u>	<u>173</u>				
<u>88862466-25</u>	<u>174</u>				
<u>88862494-89</u>	<u>175</u>				
<u>88862495-89</u>	<u>175</u>				
<u>88862497-89</u>	<u>175</u>				

Surgipro™ II and Surgipro™ 7-0, 8-0; Sofsilik™ 8-0; Polysorb™, Biosyn™, Monosoft™, Maxon™, Velosorb™ Fast sutures differ from USP and EP only in diameter. Please refer to IFU for more details.

© 2018 Medtronic. All rights reserved. Medtronic, Medtronic logo and Further, Together are trademarks of Medtronic.

™*Third party brands are trademarks of their respective owners.

All other brands are trademarks of a Medtronic company.

11/2018 US170542

DERMALON™/MONOSOF™

Monofilament Nylon Non-Absorbable Sutures

Description	DERMALON™ and MONOSOF™ monofilament sutures are inert, nonabsorbable, sterile surgical sutures composed of the longchain aliphatic polymers Nylon 6 and Nylon 6.6.
Indications	DERMALON™ and MONOSOF™ monofilament nylon sutures are indicated for use in general soft tissue approximation and/or ligation, including use in cardiovascular, ophthalmic, and neurological surgery.
Actions	Both DERMALON™ and MONOSOF™ monofilament nylon sutures elicit a minimal acute inflammatory reaction in tissue, which is followed by gradual encapsulation of the suture by fibrous connective tissue.
Tensile Strength	As with any nylon suture, though not absorbed, progressive hydrolysis of the suture, in vivo, may result in gradual loss of its tensile strength over time.
Sterilization	DERMALON™ and MONOSOF™ monofilament nylon sutures are sterilized by ethylene oxide or gamma irradiation.
Packaging	DERMALON™ monofilament nylon sutures are available dyed blue with FD&C Blue No. 2 in sizes 2-0 (3 Metric) through 6-0 (0.7 metric). MONOSOF™ monofilament nylon sutures are available either clear (undyed) or dyed black with Logwood extract, in sizes 2 (5 Metric) through 11-0 (0.1 Metric). Both sutures are supplied sterile, in pre-cut lengths affixed to needles using permanent needle attachment techniques Please refer to the individual package IFUs for complete instructions, indications, contraindications, warnings and precautions.

DERMALON™/MONOSOF™

Monofilament Nylon Non-Absorbable Sutures

NON NEEDLED - PRE-CUT								
Description	USP Size	EP Size	Length (in)	Length (cm)	Color	Units per box	Comments	Reorder code
PRE-CUT	3-0	2	18	45	BLACK	36	12 strands	N-63
	2-0	3	18	45	BLACK	36	6 strands	N-59
	2	5	18	45	BLACK	36	6 strands	N-64

Surgipro™ II and Surgipro™ 7-0, 8-0; Sofsilik™ 8-0; Polysorb™, Biosyn™, Monosof™, Maxon™, Velosorb™ Fast sutures differ from USP and EP only in diameter. Please refer to IFU for more details.

© 2018 Medtronic. All rights reserved. Medtronic, Medtronic logo and Further, Together are trademarks of Medtronic.

™*Third party brands are trademarks of their respective owners.

All other brands are trademarks of a Medtronic company.

11/2018 US170542

DERMALON™/MONOSOF™

Monofilament Nylon Non-Absorbable Sutures

REVERSE CUTTING									
Description	USP Size	EP Size	Length (in)	Length (cm)	Color	Units per box	Comments	Reorder code	
C-1 3/8 CIRCLE 12mm 	6-0	0.7	10	25	BLACK	12	Reliapoint™needle	SN-770G	
	6-0	0.7	18	45	BLACK	12	Reliapoint™needle	SN-667G	
	6-0	0.7	18	45	BLUE	36		88861741-11	
	6-0	0.7	18	45	BLACK	36	Reliapoint™needle	SN-667	
	6-0	0.7	30	75	BLACK	36		SN-367	
	5-0	1	10	25	BLACK	12	Reliapoint™needle	SN-771G	
	5-0	1	18	45	BLACK	36	Reliapoint™needle	SN-871	
	5-0	1	18	45	BLUE	36	Reliapoint™needle	88861741-21	
	5-0	1	30	75	BLACK	36	Reliapoint™needle	SN-368	
	4-0	1.5	10	25	BLACK	12	Reliapoint™needle	SN-772G	
	4-0	1.5	18	45	BLACK	36	Reliapoint™needle	SN-872	
	4-0	1.5	18	45	BLUE	36	Reliapoint™needle	88861741-31	
C-12 3/8 CIRCLE 16mm 	6-0	0.7	18	45	BLUE	36	Reliapoint™needle	88861747-11	
	6-0	0.7	18	45	BLACK	36	Reliapoint™needle	SN-660	
	6-0	0.7	30	75	BLACK	36	Reliapoint™needle	SN-760	
	5-0	1	18	45	BLACK	36	Reliapoint™needle	SN-659	
	5-0	1	18	45	BLACK	12	Reliapoint™needle	SN-659G	
	5-0	1	30	75	BLACK	36	Reliapoint™needle	SN-761	
	4-0	1.5	30	75	BLACK	36	Reliapoint™needle	SN-762	
	3-0	2	30	75	BLACK	36	Reliapoint™needle	SN-763	

Surgipro™ II and Surgipro™ 7-0, 8-0; Sofsilik™ 8-0; Polysorb™, Biosyn™, Monosof™, Maxon™, Velosorb™ Fast sutures differ from USP and EP only in diameter. Please refer to IFU for more details.

© 2018 Medtronic. All rights reserved. Medtronic, Medtronic logo and Further, Together are trademarks of Medtronic.

™*Third party brands are trademarks of their respective owners.

All other brands are trademarks of a Medtronic company.

11/2018 US170542

DERMALON™/MONOSOF™

Monofilament Nylon Non-Absorbable Sutures

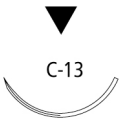
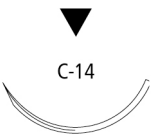
REVERSE CUTTING								
Description	USP Size	EP Size	Length (in)	Length (cm)	Color	Units per box	Comments	Reorder code
C-13 3/8 CIRCLE 19mm 	6-0	0.7	18	45	BLUE	36	Reliapoint™needle	88861756-11
	5-0	1	18	45	BLACK	12	Reliapoint™needle	SN-661G
	5-0	1	18	45	BLUE	36	Reliapoint™needle	88861756-21
	5-0	1	18	45	BLACK	36	Reliapoint™needle	SN-661
	5-0	1	30	75	BLACK	36	Reliapoint™needle	SN-643
	4-0	1.5	10	25	BLACK	12	Reliapoint™needle	SN-552G
	4-0	1.5	18	45	BLACK	12	Reliapoint™needle	SN-662G
	4-0	1.5	18	45	BLUE	36	Reliapoint™needle	88861756-31
	4-0	1.5	18	45	BLACK	36	Reliapoint™needle	SN-662
	4-0	1.5	30	75	BLUE	36	Reliapoint™needle	88861757-31
	4-0	1.5	36	90	BLACK	36	Reliapoint™needle	SN-644
	3-0	2	30		BLACK	36	Reliapoint™needle	SN641
	3-0	2	18	45	BLACK	36	Reliapoint™needle	SN-653
	3-0	2	18	45	BLUE	36	Reliapoint™needle	88861756-41
	3-0	2	30	75	BLUE	36	Reliapoint™needle	88861757-41
	3-0	2	36	90	BLACK	36	Reliapoint™needle	SN-665
	2-0	3	18	45	BLUE	36	Reliapoint™needle	88861756-51
	2-0	3	30	75	BLACK	36	Reliapoint™needle	SN-750
	2-0	3	36	90	BLACK	36	Reliapoint™needle	SN-666
	C-14 3/8 CIRCLE 24mm 	4-0	1.5	18	45	BLACK	36	Reliapoint™needle
4-0		1.5	18	45	BLUE	36	Reliapoint™needle	88861744-31
4-0		1.5	30	75	BLUE	36	Reliapoint™needle	88861799-31
4-0		1.5	36	90	BLACK	36	Reliapoint™needle	SN-649
3-0		2	18	45	BLACK	36	Reliapoint™needle	SN-663
3-0		2	18	45	BLUE	36	Reliapoint™needle	88861744-41
3-0		2	18	45	BLACK	12	Reliapoint™needle	SN-663G
3-0		2	30	75	BLACK	36	Reliapoint™needle	SN-669
3-0		2	30	75	BLUE	36	Reliapoint™needle	88861799-41
3-0		2	36	90	BLACK	36	Reliapoint™needle	SN-648
3-0		2	36	90	BLACK	12		SN648G
2-0		3	18	45	BLACK	36	Reliapoint™needle	SN-758
2-0		3	30	75	BLUE	36	Reliapoint™needle	88861799-51
2-0		3	36	90	BLACK	36	Reliapoint™needle	SN-747

Surgipro™ II and Surgipro™ 7-0, 8-0; Sofsilik™ 8-0; Polysorb™, Biosyn™, Monosof™, Maxon™, Velosorb™ Fast sutures differ from USP and EP only in diameter. Please refer to IFU for more details.

© 2018 Medtronic. All rights reserved. Medtronic, Medtronic logo and Further, Together are trademarks of Medtronic.



™*Third party brands are trademarks of their respective owners.

All other brands are trademarks of a Medtronic company.

11/2018 US170542

DERMALON™/MONOSOF™

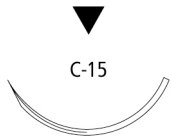
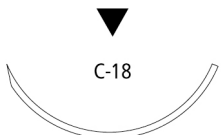
Monofilament Nylon Non-Absorbable Sutures

REVERSE CUTTING								
Description	USP Size	EP Size	Length (in)	Length (cm)	Color	Units per box	Comments	Reorder code
C-15 3/8 CIRCLE 26mm 	2-0	3	18	45	BLACK	36	Reliapoint™needle	SN-764
	2-0	3	18	45	BLACK	12	Reliapoint™needle	SN-764G
	2-0	3	18	45	BLUE	36	Reliapoint™needle	88861744-51
	2-0	3	30	75	BLACK	12	Reliapoint™needle	SN-664G
	2-0	3	30	75	BLACK	36	Reliapoint™needle	SN-664
	2-0	3	36	90	BLUE	36	Reliapoint™needle	88861720-51
	0	3.5	30	75	BLACK	36	Reliapoint™needle	SN765
C-16 3/8 CIRCLE 30mm 	4-0	1.5	30	75	BLACK	36	Reliapoint™needle	SN-670
	3-0	2	30	75	BLACK	36	Reliapoint™needle	SN-671
	3-0	2	30	75	BLUE	36	Reliapoint™needle	88861750-41
	3-0	2	30	75	BLACK	12	Reliapoint™needle	SN-671G
	3-0	2	36	90	BLACK	36	Reliapoint™needle	SN-771
	2-0	3	30	75	BLACK	36	Reliapoint™needle	SN-688
	2-0	3	36	90	BLACK	36	Reliapoint™needle	SN-788
	0	3.5	30	75	BLACK	36	Reliapoint™needle	SN-689
	1	4	36	90	BLACK	36	Reliapoint™needle	SN-790
C-18 3/8 CIRCLE 35mm 	3-0	2	36	90	BLACK	36	Reliapoint™needle	SN-693
	2-0	3	36	90	BLACK	36	Reliapoint™needle	SN-694
C-17 3/8 CIRCLE 39mm 	4-0	1.5	30	75	BLACK	36	Reliapoint™needle	SN-672
	3-0	2	30	75	BLACK	36	Reliapoint™needle	SN-673
	3-0	2	30	75	BLACK	12	Reliapoint™needle	SN-673G
	3-0	2	30	75	BLUE	36	Reliapoint™needle	88861727-41
	2-0	3	30	75	BLUE	36	Reliapoint™needle	88861727-51
	2-0	3	30	75	BLACK	36	Reliapoint™needle	SN-674
	0	3.5	36	90	BLACK	36	Reliapoint™needle	SN-775
	2	5	36	90	BLACK	36	Reliapoint™needle	SN-777
	1	4	36	90	BLACK	36	Reliapoint™needle	SN-776
	1	4	36	90	BLACK	12		SN776G
GS-18 3/8 CIRCLE 77mm (Not to scale) 	2	5	18	45	BLACK	24		CN-290

Surgipro™ II and Surgipro™ 7-0, 8-0; Sofsilik™ 8-0; Polysorb™, Biosyn™, Monosof™, Maxon™, Velosorb™ Fast sutures differ from USP and EP only in diameter. Please refer to IFU for more details.

© 2018 Medtronic. All rights reserved. Medtronic, Medtronic logo and Further, Together are trademarks of Medtronic.

™*Third party brands are trademarks of their respective owners.

All other brands are trademarks of a Medtronic company.

11/2018 US170542

DERMALON™/MONOSOF™

Monofilament Nylon Non-Absorbable Sutures

REVERSE CUTTING									
Description	USP Size	EP Size	Length (in)	Length (cm)	Color	Units per box	Comments	Reorder code	
GS-18 - GS-18 3/8 CIRCLE 77mm (Double armed) (Not to scale)	2	5	30	75	BLACK	24		CN-490	
C-22 1/2 CIRCLE 18mm	5-0	1	30	75	BLACK	36	Reliapoint™needle	SN-629	
	4-0	1.5	30	75	BLACK	36	Reliapoint™needle	SN-630	
	3-0	2	30	75	BLACK	36	Reliapoint™needle	SN-631	
C-23 1/2 CIRCLE 24mm	3-0	2	36	90	BLACK	36	Reliapoint™needle	SN-247	
C-25 1/2 CIRCLE 30mm	3-0	2	30	75	BLACK	36	Reliapoint™needle	SN-681	
	3-0	2	36	90	BLACK	36	Reliapoint™needle	SN-781	
	2-0	3	30	75	BLACK	36	Reliapoint™needle	SN-682	
	2-0	3	36	90	BLACK	36	Reliapoint™needle	SN-782	
GS-11 1/2 CIRCLE 37mm	3-0	2	36	90	BLACK	36		SN-881	
	2-0	3	30	75	BLACK	36		CN-819	
	1	4	36	90	BLACK	36		CN-822	

Surgipro™ II and Surgipro™ 7-0, 8-0; Sofsilik™ 8-0; Polysorb™, Biosyn™, Monosof™, Maxon™, Velosorb™ Fast sutures differ from USP and EP only in diameter. Please refer to IFU for more details.

© 2018 Medtronic. All rights reserved. Medtronic, Medtronic logo and Further, Together are trademarks of Medtronic.



™*Third party brands are trademarks of their respective owners.

All other brands are trademarks of a Medtronic company.

11/2018 US170542

DERMALON™/MONOSOF™

Monofilament Nylon Non-Absorbable Sutures

PREMIUM REVERSE CUTTING									
Description	USP Size	EP Size	Length (in)	Length (cm)	Color	Units per box	Comments	Reorder code	
P-16 3/8 CIRCLE 7mm 	7-0	0.5	18	45	BLACK	36	Edgellant™ needle, Surgalloy™ alloy	SN-1647	
	7-0	0.5	18	45	BLACK	12	Edgellant™ needle, Surgalloy™ alloy	SN-1647G	
P-10 3/8 CIRCLE 11mm 	7-0	0.5	18	45	BLACK	12	Edgellant™ needle, Surgalloy™ alloy	SN-3686	
	6-0	0.7	18	45	CLEAR	36	Edgellant™ needle, Surgalloy™ alloy	SN-1689	
	6-0	0.7	18	45	BLACK	36	Edgellant™ needle, Surgalloy™ alloy	SN-5697	
	6-0	0.7	18	45	BLACK	12	Edgellant™ needle, Surgalloy™ alloy	SN-3697	
	6-0	0.7	18	45	BLUE	12	Edgellant™ needle, Surgalloy™ alloy	88861754-13	
	6-0	0.7	18	45	CLEAR	12	Edgellant™ needle, Surgalloy™ alloy	SN-1689G	
	5-0	1	18	45	BLACK	12	Edgellant™ needle, Surgalloy™ alloy	SN-3695	
P-13 3/8 CIRCLE 13mm 	6-0	0.7	18	45	BLACK	36	Edgellant™ needle, Surgalloy™ alloy	SN-5696	
	6-0	0.7	18	45	BLUE	12	Edgellant™ needle, Surgalloy™ alloy	SDN-5696G	
	6-0	0.7	18	45	BLACK	12	Edgellant™ needle, Surgalloy™ alloy	SN-5696G	
	5-0	1	18	45	BLACK	12	Edgellant™ needle, Surgalloy™ alloy	SN-5698G	
	5-0	1	18	45	CLEAR	12	Edgellant™ needle, Surgalloy™ alloy	SN-5690G	
	5-0	1	18	45	BLUE	12	Edgellant™ needle, Surgalloy™ alloy	88861749-24	
	5-0	1	18	45	CLEAR	36	Edgellant™ needle, Surgalloy™ alloy	SN-5690	
	5-0	1	18	45	BLACK	36	Edgellant™ needle, Surgalloy™ alloy	SN-5698	
	4-0	1.5	18	45	CLEAR	36	Edgellant™ needle, Surgalloy™ alloy	SN-5691	
	4-0	1.5	18	45	BLACK	36	Edgellant™ needle, Surgalloy™ alloy	SN-5699	
	4-0	1.5	18	45	BLUE	12	Edgellant™ needle, Surgalloy™ alloy	SDN-5691G	
	4-0	1.5	18	45	BLACK	12	Edgellant™ needle, Surgalloy™ alloy	SN-5699G	

Surgipro™ II and Surgipro™ 7-0, 8-0; Sofsilik™ 8-0; Polysorb™, Biosyn™, Monosof™, Maxon™, Velosorb™ Fast sutures differ from USP and EP only in diameter. Please refer to IFU for more details.

© 2018 Medtronic. All rights reserved. Medtronic, Medtronic logo and Further, Together are trademarks of Medtronic.

™*Third party brands are trademarks of their respective owners.

All other brands are trademarks of a Medtronic company.

11/2018 US170542

DERMALON™/MONOSOF™

Monofilament Nylon Non-Absorbable Sutures

PREMIUM REVERSE CUTTING									
Description	USP Size	EP Size	Length (in)	Length (cm)	Color	Units per box	Comments	Reorder code	
P-11 3/8 CIRCLE 16mm 	6-0	0.7	18	45	BLACK	12	Edgellant™ needle, Surgalloy™ alloy	SN-5767G	
	5-0	1	18	45	BLACK	12	Edgellant™ needle, Surgalloy™ alloy	SN-5668G	
	5-0	1	18	45	BLACK	36	Edgellant™ needle, Surgalloy™ alloy	SN-5668	
	4-0	1.5	18	45	BLACK	36	Edgellant™ needle, Surgalloy™ alloy	SN-5694	
	4-0	1.5	18	45	BLACK	12	Edgellant™ needle, Surgalloy™ alloy	SN-5694G	
P-12 3/8 CIRCLE 19mm 	6-0	0.7	18	45	BLACK	12	Edgellant™ needle, Surgalloy™ alloy	SN-5665G	
	5-0	1	18	45	BLACK	12	Edgellant™ needle, Surgalloy™ alloy	SN-5666G	
	5-0	1	18	45	BLACK	36	Edgellant™ needle, Surgalloy™ alloy	SN-5666	
	4-0	1.5	18	45	BLACK	36	Edgellant™ needle, Surgalloy™ alloy	SN-5667	
	4-0	1.5	18	45	CLEAR	12	Edgellant™ needle, Surgalloy™ alloy	SN-5677	
	4-0	1.5	18	45	BLUE	12	Edgellant™ needle, Surgalloy™ alloy	SDN-5666G	
	4-0	1.5	18	45	BLACK	12	Edgellant™ needle, Surgalloy™ alloy	SN-5667G	
	3-0	2	18	45	BLACK	12	Edgellant™ needle, Surgalloy™ alloy	SN-5669G	
	3-0	2	18	45	BLACK	36	Edgellant™ needle, Surgalloy™ alloy	SN-5669	
	2-0	3	18	45	BLACK	36	Edgellant™ needle, Surgalloy™ alloy	SN-5670	
P-14 3/8 CIRCLE 24mm 	4-0	1.5	18	45	BLACK	12	Edgellant™ needle, Surgalloy™ alloy	SN-5862G	
	3-0	2	18	45	BLUE	12	Edgellant™ needle, Surgalloy™ alloy	SDN-5943G	
	3-0	2	18	45	BLACK	12	Edgellant™ needle, Surgalloy™ alloy	SN-5663G	
	3-0	2	18	45	BLACK	36	Edgellant™ needle, Surgalloy™ alloy	SN-5663	
P-24 1/2 CIRCLE 16mm 	6-0	0.7	18	45	BLACK	12	Edgellant™ needle, Surgalloy™ alloy	SN-5660G	
	5-0	1	18	45	BLACK	12	Surgalloy™	SN-5661G	
	4-0	1.5	18	45	BLACK	12	Edgellant™ needle, Surgalloy™ alloy	SN-5662G	
	4-0	1.5	18	45	BLACK	36	Edgellant™ needle, Surgalloy™ alloy	SN-5662	

Surgipro™ II and Surgipro™ 7-0, 8-0; Sofsilik™ 8-0; Polysorb™, Biosyn™, Monosof™, Maxon™, Velosorb™ Fast sutures differ from USP and EP only in diameter. Please refer to IFU for more details.

© 2018 Medtronic. All rights reserved. Medtronic, Medtronic logo and Further, Together are trademarks of Medtronic.

™*Third party brands are trademarks of their respective owners.

All other brands are trademarks of a Medtronic company.

11/2018 US170542

DERMALON™/MONOSOF™

Monofilament Nylon Non-Absorbable Sutures

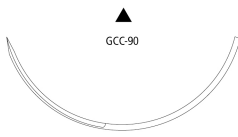
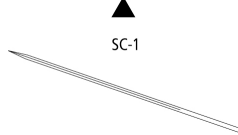
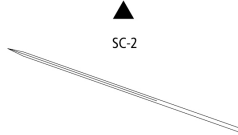
CONVENTIONAL CUTTING								
Description	USP Size	EP Size	Length (in)	Length (cm)	Color	Units per box	Comments	Reorder code
SCE-4 3/8 CIRCLE 19mm 	5-0	1	18	45	BLUE	36		88861742-21
	4-0	1.5	18	45	BLUE	36		88861742-31
	4-0	1.5	18	45	BLACK	36		SN-568
	3-0	2	18	45	BLUE	36		88861742-41
GCC-90 3/8 CIRCLE 90mm (Not to scale) 	2-0	3	40	100	BLACK	36		CN-791
	0	3.5	40	100	BLACK	36		CN-792
	1	4	40	100	BLACK	36		CN-793
SC-1 STRAIGHT 51mm (Not to scale) 	4-0	1.5	36	90	BLACK	36		SN-615
	3-0	2	36	90	BLACK	36		SN-616
	2-0	3	36	90	BLACK	36		SN-617
SC-2 STRAIGHT 60mm (Not to scale) 	4-0	1.5	30	75	BLACK	36		SN-626
	3-0	2	30	75	BLACK	36		SN-627
	3-0	2	30	75	BLUE	36		88861764-41
	2-0	3	30	75	BLUE	36		88861764-51
	2-0	3	30	75	BLACK	36		SN-628
	2-0	3	40	100	BLACK	36		SN-728

Surgipro™ II and Surgipro™ 7-0, 8-0; Sofsilik™ 8-0; Polysorb™, Biosyn™, Monosof™, Maxon™, Velosorb™ Fast sutures differ from USP and EP only in diameter. Please refer to IFU for more details.

© 2018 Medtronic. All rights reserved. Medtronic, Medtronic logo and Further, Together are trademarks of Medtronic.





















™*Third party brands are trademarks of their respective owners.

All other brands are trademarks of a Medtronic company.

11/2018 US170542

DERMALON™/MONOSOF™

Monofilament Nylon Non-Absorbable Sutures

TAPER POINT									
Description		USP Size	EP Size	Length (in)	Length (cm)	Color	Units per box	Comments	Reorder code
MV-135-3 3/8 CIRCLE 4mm	 MV-135-3 	10-0	0.2	5	13	BLACK	12	Surgalloy™	N-2540
		9-0	0.3	3	8	BLACK	12	Surgalloy™	N-1603G
		8-0	0.4	5	13	BLACK	12	Surgalloy™	N-2541
MV-50-3 3/8 CIRCLE 4mm	 MV-50-3 	11-0	0.1	5	13	BLACK	12	Surgalloy™	N-2500
MV-70-3 3/8 CIRCLE 4mm	 MV-70-3 	11-0	0.1	5	13	BLACK	12	Surgalloy™	N-2510
		10-0	0.2	5	13	BLACK	12	Surgalloy™	N-2512
MV-100-4 3/8 CIRCLE 5mm	 MV-100-4 	10-0	0.2	5	13	BLACK	12	Surgalloy™	N-2530
		9-0	0.3	5	13	BLACK	12	Surgalloy™	N-2532
MV-135-4 3/8 CIRCLE 5mm	 MV-135-4 	10-0	0.2	5	13	BLACK	12	Surgalloy™	N-2544
		9-0	0.3	5	13	BLACK	12	Surgalloy™	N-2546
		8-0	0.4	5	13	BLACK	12	Surgalloy™	N-2543
MV-70-4 3/8 CIRCLE 5mm	 MV-70-4 	10-0	0.2	5	13	BLACK	12	Surgalloy™	N-2514
MV-135-5 3/8 CIRCLE 6mm	 MV-135-5 	9-0	0.3	5	13	BLACK	12	Surgalloy™	N-2548
		8-0	0.4	5	13	BLACK	12	Surgalloy™	N-2547
GS-22 1/2 CIRCLE 27mm	 GS-22 	0	3.5	40	100	BLACK	36		CN-225
GS-21 1/2 CIRCLE 37mm	 GS-21 	0	3.5	40	100	BLACK	36		CN-623
GS-24 1/2 CIRCLE 40mm	 GS-24 	0	3.5	40	100	BLACK	36		CN-723
		1	4	40	100	BLACK	36		CN-722

Surgipro™ II and Surgipro™ 7-0, 8-0; Sofsilik™ 8-0; Polysorb™, Biosyn™, Monosof™, Maxon™, Velosorb™ Fast sutures differ from USP and EP only in diameter. Please refer to IFU for more details.

© 2018 Medtronic. All rights reserved. Medtronic, Medtronic logo and Further, Together are trademarks of Medtronic.

™*Third party brands are trademarks of their respective owners.

All other brands are trademarks of a Medtronic company.

11/2018 US170542

DERMALON™/MONOSOF™

Monofilament Nylon Non-Absorbable Sutures

TAPER POINT									
Description	USP Size	EP Size	Length (in)	Length (cm)	Color	Units per box	Comments	Reorder code	
GS-24 LOOP 1/2 CIRCLE 40mm 	0	3.5	60	150	BLACK	24		CN-825-L	
GS-25 1/2 CIRCLE 48mm (Not to scale) 	1	4	40	100	BLACK	36		CN-724	
	1	4	60	150	BLACK	12		CN830GL	
GS-25 LOOP 1/2 CIRCLE 48mm (Not to scale) 	1	4	60	150	BLACK	24		CN-830-L	
GS-26 1/2 CIRCLE 65mm (Not to scale) 	2	5	60	150	BLACK	24		CN-825	
	1	4	60	150	BLACK	24		CN-824	
GS-26 LOOP 1/2 CIRCLE 65mm (Not to scale) 	0	3.5	96	240	BLACK	24		CN-823-L	
ST - ST STRAIGHT 60mm (Double armed) (Not to scale) 	2-0	3	36	90	BLACK	12		GNJ-283	
	2-0	3	36	90	BLACK	36		GN-283	
	0	3.5	36	90	BLACK	36		GN-284	

HEAVY TAPER POINT									
Description	USP Size	EP Size	Length (in)	Length (cm)	Color	Units per box	Comments	Reorder code	
HGS-22 1/2 CIRCLE 27mm 	0	3.5	40	100	BLACK	36		CN-925	
	1	4	40	100	BLACK	36		CN-926	

Surgipro™ II and Surgipro™ 7-0, 8-0; Sofsil™ 8-0; Polysorb™, Biosyn™, Monosof™, Maxon™, Velosorb™ Fast sutures differ from USP and EP only in diameter. Please refer to IFU for more details.

© 2018 Medtronic. All rights reserved. Medtronic, Medtronic logo and Further, Together are trademarks of Medtronic.





™*Third party brands are trademarks of their respective owners.

All other brands are trademarks of a Medtronic company.

11/2018 US170542

DERMALON™/MONOSOF™

Monofilament Nylon Non-Absorbable Sutures

TAPERCUTTING									
Description		USP Size	EP Size	Length (in)	Length (cm)	Color	Units per box	Comments	Reorder code
MVK-70-3 3/8 CIRCLE 4mm	 MVK-70-3 	10-0	0.2	5	13	BLACK	12	Surgalloy™	N-2513
MVK-100-4 3/8 CIRCLE 5mm	 MVK-100-4 	10-0	0.2	5	13	BLACK	12	Surgalloy™	N-2531
		9-0	0.3	5	13	BLACK	12	Surgalloy™	N-2533

BLUNT TAPER POINT									
Description		USP Size	EP Size	Length (in)	Length (cm)	Color	Units per box	Comments	Reorder code
BGS-25 1/2 CIRCLE 48mm (Not to scale)	 BGS-25	1	4	40	100	BLACK	36	Protect Point™	CN-771

Surgipro™ II and Surgipro™ 7-0, 8-0; Sofsilik™ 8-0; Polysorb™, Biosyn™, Monosof™, Maxon™, Velosorb™ Fast sutures differ from USP and EP only in diameter. Please refer to IFU for more details.

© 2018 Medtronic. All rights reserved. Medtronic, Medtronic logo and Further, Together are trademarks of Medtronic.























™*Third party brands are trademarks of their respective owners.

All other brands are trademarks of a Medtronic company.

11/2018 US170542

DERMALON™/MONOSOF™

Monofilament Nylon Non-Absorbable Sutures

PREMIUM SPATULA									
Description	USP Size	EP Size	Length (in)	Length (cm)	Color	Units per box	Comments	Reorder code	
SE-100-8 - SE-100-8 1/4 CIRCLE 6.3mm (Double armed)  SE-100-8 	8-0	0.4	12	30	BLACK	12	Surgalloy™	N-2714K	
SS-24 - SS-24 1/4 CIRCLE 8.6mm (Double armed)  SS-24 	5-0	1	18	45	BLACK	12	Surgalloy™	N-2781K	
SE-140-6 3/8 CIRCLE 6.3mm  SE-140-6 	10-0	0.2	8	20	BLACK	12	Surgalloy™	N-2730-K	
SE-140-6 - SE-140-6 3/8 CIRCLE 6.3mm (Double armed)  SE-140-6 	10-0	0.2	12	30	BLACK	12	Surgalloy™	N-2770-K	
	9-0	0.3	12	30	BLACK	12	Surgalloy™	N-2771-K	
SE-140-8 3/8 CIRCLE 6.3mm  SE-140-8 	10-0	0.2	8	20	BLACK	12	Surgalloy™	N-2736K	
SE-140-8 - SE-140-8 3/8 CIRCLE 6.3mm (Double armed)  SE-140-8 	10-0	0.2	12	30	BLACK	12	Surgalloy™	N-2718K	
	9-0	0.3	12	30	BLACK	12	Surgalloy™	N-2717-K	
SE-CC-6 - SE-CC-6 COMPOUND CURVE 4.8mm (Double armed)  SE-CC-6 	10-0	0.2	8	20	BLACK	12	Surgalloy™	N-2721-K	
	10-0	0.2	12	30	BLACK	12	Surgalloy™	N-2799-K	
SE-160-4 - SE-160-4 1/2 CIRCLE 5.5mm (Double armed)  SE-160-4 	11-0	0.1	12	30	BLACK	12	Surgalloy™	N-2705K	
	10-0	0.2	12	30	BLACK	12	Surgalloy™	N-2704K	
SE-160-6 1/2 CIRCLE 5.5mm  SE-160-6 	10-0	0.2	8	20	BLACK	12	Surgalloy™	N-2734K	
SE-160-6 - SE-160-6 1/2 CIRCLE 5.5mm (Double armed)  SE-160-6 	10-0	0.2	6	15	BLACK	12	Surgalloy™	N-2757K	
	10-0	0.2	12	30	BLACK	12	Surgalloy™	N-2756K	
	9-0	0.3	12	30	BLACK	12	Surgalloy™	N-2760K	
SE-160-8 1/2 CIRCLE 5.5mm  SE-160-8 	10-0	0.2	6	15	BLACK	12	Surgalloy™	N-2766K	

Surgipro™ II and Surgipro™ 7-0, 8-0; Sofsilik™ 8-0; Polysorb™, Biosyn™, Monosof™, Maxon™, Velosorb™ Fast sutures differ from USP and EP only in diameter. Please refer to IFU for more details.

© 2018 Medtronic. All rights reserved. Medtronic, Medtronic logo and Further, Together are trademarks of Medtronic.





™*Third party brands are trademarks of their respective owners.

All other brands are trademarks of a Medtronic company.

11/2018 US170542

DERMALON™/MONOSOF™

Monofilament Nylon Non-Absorbable Sutures

PREMIUM SPATULA									
Description	USP Size	EP Size	Length (in)	Length (cm)	Color	Units per box	Comments	Reorder code	
SE-160-8 - SE-160-8 1/2 CIRCLE 5.5mm (Double armed) 	10-0	0.2	12	30	BLACK	12	Surgalloy™	N-2786K	
	9-0	0.3	12	30	BLACK	12	Surgalloy™	N-2787K	
SE-175-8 - SE-175-8 1/2 CIRCLE 6.9mm (Double armed) 	10-0	0.2	12	30	BLACK	12	Surgalloy™	N-2719K	
	8-0	0.4	12	30	BLACK	12	Surgalloy™	N-2716K	
SE-175-6 - SE-175-6 1/2 CIRCLE 7mm (Double armed) 	10-0	0.2	12	30	BLACK	12		N-2966K	
	9-0	0.3	12	30	BLACK	12		N-2967	
SS-2 - SS-2 1/2 CIRCLE 8.6mm (Double armed) 	5-0	1	18	45	BLACK	12	Surgalloy™	N-2761K	

PREMIUM CONVENTIONAL CUTTING									
Description	USP Size	EP Size	Length (in)	Length (cm)	Color	Units per box	Comments	Reorder code	
PC-13 3/8 CIRCLE 11mm	6-0	0.7	18	45	BLACK	36		SN-1956	
	5-0	1	18	45	BLACK	36		SN-1955	
	4-0	1.5	18	45	BLACK	36		SN-1954	
PC-11 3/8 CIRCLE 16mm	6-0	0.7	18	45	BLACK	36		SN-1966	
	5-0	1	18	45	BLACK	12	Surgalloy™	SN-3965	
	4-0	1.5	18	45	BLACK	36		SN-1964	
PC-12 3/8 CIRCLE 19mm	5-0	1	18	45	BLACK	36		SN-1995	
	4-0	1.5	18	45	BLACK	36		SN-1994	
	3-0	2	18	45	BLACK	36		SN-1693	

Surgipro™ II and Surgipro™ 7-0, 8-0; Sofsil™ 8-0; Polysorb™, Biosyn™, Monosof™, Maxon™, Velosorb™ Fast sutures differ from USP and EP only in diameter. Please refer to IFU for more details.

© 2018 Medtronic. All rights reserved. Medtronic, Medtronic logo and Further, Together are trademarks of Medtronic.

™*Third party brands are trademarks of their respective owners.

All other brands are trademarks of a Medtronic company.

11/2018 US170542

DERMALON™/MONOSOF™

Monofilament Nylon Non-Absorbable Sutures

Reorder Code	Page	Reorder Code	Page	Reorder Code	Page
88861720-51	182	CN-819	183	N-2734K	190
88861727-41	182	CN-822	183	N-2736K	190
88861727-51	182	CN-823-L	188	N-2756K	190
88861741-11	180	CN-824	188	N-2757K	190
88861741-21	180	CN-825	188	N-2760K	190
88861741-31	180	CN-825-L	188	N-2761K	191
88861742-21	186	CN830GL	188	N-2766K	190
88861742-31	186	CN-830-L	188	N-2770-K	190
88861742-41	186	CN-925	188	N-2771-K	190
88861744-31	181	CN-926	188	N-2781K	190
88861744-41	181	GN-283	188	N-2786K	191
88861744-51	182	GN-284	188	N-2787K	191
88861747-11	180	GNJ-283	188	N-2799-K	190
88861749-24	184	N-1603G	187	N-2966K	191
88861750-41	182	N-2500	187	N-2967	191
88861754-13	184	N-2510	187	N-59	179
88861756-11	181	N-2512	187	N-63	179
88861756-21	181	N-2513	189	N-64	179
88861756-31	181	N-2514	187	SDN-5666G	185
88861756-41	181	N-2530	187	SDN-5691G	184
88861756-51	181	N-2531	189	SDN-5696G	184
88861757-31	181	N-2532	187	SDN-5943G	185
88861757-41	181	N-2533	189	SN-1647	184
88861764-41	186	N-2540	187	SN-1647G	184
88861764-51	186	N-2541	187	SN-1689	184
88861799-31	181	N-2543	187	SN-1689G	184
88861799-41	181	N-2544	187	SN-1693	191
88861799-51	181	N-2546	187	SN-1954	191
CN-225	187	N-2547	187	SN-1955	191
CN-290	182	N-2548	187	SN-1956	191
CN-490	183	N-2704K	190	SN-1964	191
CN-623	187	N-2705K	190	SN-1966	191
CN-722	187	N-2714K	190	SN-1994	191
CN-723	187	N-2716K	191	SN-1995	191
CN-724	188	N-2717-K	190	SN-247	183
CN-771	189	N-2718K	190	SN-367	180
CN-791	186	N-2719K	191	SN-368	180
CN-792	186	N-2721-K	190	SN-3686	184
CN-793	186	N-2730-K	190	SN-3695	184

Surgipro™ II and Surgipro™ 7-0, 8-0; Sofsilik™ 8-0; Polysorb™, Biosyn™, Monosof™, Maxon™, Velosorb™ Fast sutures differ from USP and EP only in diameter.

Please refer to IFU for more details.

© 2018 Medtronic. All rights reserved. Medtronic, Medtronic logo and Further, Together are trademarks of Medtronic.

™*Third party brands are trademarks of their respective owners.

All other brands are trademarks of a Medtronic company.

11/2018 US170542

DERMALON™/MONOSOF™

Monofilament Nylon Non-Absorbable Sutures

Reorder Code	Page	Reorder Code	Page	Reorder Code	Page
SN-3697	184	SN-627	186	SN-689	182
SN-3965	191	SN-628	186	SN-693	182
SN-552G	181	SN-629	183	SN-694	182
SN-5660G	185	SN-630	183	SN-728	186
SN-5661G	185	SN-631	183	SN-747	181
SN-5662	185	SN641	181	SN-750	181
SN-5662G	185	SN-643	181	SN-758	181
SN-5663	185	SN-644	181	SN-760	180
SN-5663G	185	SN-648	181	SN-761	180
SN-5665G	185	SN648G	181	SN-762	180
SN-5666	185	SN-649	181	SN-763	180
SN-5666G	185	SN-653	181	SN-764	182
SN-5667	185	SN-658	181	SN-764G	182
SN-5667G	185	SN-659	180	SN765	182
SN-5668	185	SN-659G	180	SN-770G	180
SN-5668G	185	SN-660	180	SN-771	182
SN-5669	185	SN-661	181	SN-771G	180
SN-5669G	185	SN-661G	181	SN-772G	180
SN-5670	185	SN-662	181	SN-775	182
SN-5677	185	SN-662G	181	SN-776	182
SN-568	186	SN-663	181	SN776G	182
SN-5690	184	SN-663G	181	SN-777	182
SN-5690G	184	SN-664	182	SN-781	183
SN-5691	184	SN-664G	182	SN-782	183
SN-5694	185	SN-665	181	SN-788	182
SN-5694G	185	SN-666	181	SN-790	182
SN-5696	184	SN-667	180	SN-871	180
SN-5696G	184	SN-667G	180	SN-872	180
SN-5697	184	SN-669	181	SN-881	183
SN-5698	184	SN-670	182		
SN-5698G	184	SN-671	182		
SN-5699	184	SN-671G	182		
SN-5699G	184	SN-672	182		
SN-5767G	185	SN-673	182		
SN-5862G	185	SN-673G	182		
SN-615	186	SN-674	182		
SN-616	186	SN-681	183		
SN-617	186	SN-682	183		
SN-626	186	SN-688	182		

Surgipro™ II and Surgipro™ 7-0, 8-0; Sofsilik™ 8-0; Polysorb™, Biosyn™, Monosof™, Maxon™, Velosorb™ Fast sutures differ from USP and EP only in diameter. Please refer to IFU for more details.

© 2018 Medtronic. All rights reserved. Medtronic, Medtronic logo and Further, Together are trademarks of Medtronic.

™*Third party brands are trademarks of their respective owners.

All other brands are trademarks of a Medtronic company.

11/2018 US170542







NOVAFIL™

Monofilament Polybutester Non-Absorbable Sutures

Description	Novafil™ monofilament polybutester sutures are nonabsorbable, sterile, surgical sutures composed of a copolymer of butylene terephthalate and polytetramethylene ether glycol.
Indications	Novafil™ polybutester sutures are indicated for use in general soft tissue approximation and/or ligation, including use in cardiovascular and ophthalmic surgery, but not in microsurgery and neural tissue.
Actions	Novafil™ polybutester sutures elicit a minimal acute inflammatory reaction in tissues, followed by gradual encapsulation of the suture by fibrous connective tissue.
Tensile Strength	Novafil™ polybutester sutures are not absorbed, nor is any significant change in tensile strength retention known to occur in vivo.
Sterilization	Gamma irradiation.
Packaging	Novafil™ polybutester sutures are available clear or pigmented with Copper Phthalocyanine Blue, in sizes 2 (5 Metric) through 7-0 (0.5 Metric). The sutures are supplied sterile, in pre-cut lengths and ligating reels, non-needled or affixed to various needle types using both permanent and removable needle attachment techniques. Please refer to the individual package IFUs for complete instructions, indications, contraindications, warnings and precautions.

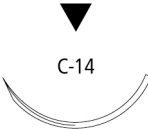
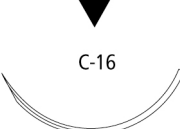
NOVAFIL™

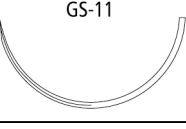
Monofilament Polybutester Non-Absorbable Sutures

REVERSE CUTTING									
Description		USP Size	EP Size	Length (in)	Length (cm)	Color	Units per box	Comments	Reorder code
C-1 3/8 CIRCLE 12mm		6-0	0.7	18	45	BLUE	12		8886441913
		5-0	1	18		BLUE	12	Reliapoint™needle	8886441923
		4-0	1.5	18		BLUE	12	Reliapoint™needle	8886441933
C-12 3/8 CIRCLE 16mm		5-0	1	18	45	BLUE	12	Reliapoint™needle	88864555-23
C-13 3/8 CIRCLE 19mm		6-0	0.7	18	45	BLUE	12		8886442013
		5-0	1	18		BLUE	12	Reliapoint™needle	8886442023
		4-0	1.5	30		BLUE	36	Reliapoint™needle	8886403231
		4-0	1.5	18		BLUE	12	Reliapoint™needle	8886442033
		3-0	2	18		BLUE	12	Reliapoint™needle	8886442043
		3-0	2	30	75	BLUE	36	Reliapoint™needle	88864554-41
C-14 3/8 CIRCLE 24mm		4-0	1.5	18		BLUE	12	Reliapoint™needle	8886442233
		3-0	2	36		BLUE	36	Reliapoint™needle	8886400241
		3-0	2	18		BLUE	12	Reliapoint™needle	8886442243
		2-0	3	18		BLUE	12	Reliapoint™needle	8886442253
		2-0	3	30		BLUE	12	Reliapoint™needle	8886442153
C-16 3/8 CIRCLE 30mm		4-0	1.5	30		BLUE	36	Reliapoint™needle	8886442431
		3-0	2	30		BLUE	36	Reliapoint™needle	8886442441
		2-0	3	30		BLUE	36	Reliapoint™needle	8886442451
		0	3.5	30		BLUE	36	Reliapoint™needle	8886442461
C-17 3/8 CIRCLE 39mm		3-0	2	30		BLUE	36	Reliapoint™needle	8886442641
		2-0	3	30		BLUE	36	Reliapoint™needle	8886442651
		0	3.5	30		BLUE	36	Reliapoint™needle	8886442661
GS-11 1/2 CIRCLE 37mm		0	3.5	40	100	BLUE	12		8886400963
		1	4	30	75	BLUE	36		8886443371
GS-13 1/2 CIRCLE 48mm (Not to scale)		1	4	30	75	BLUE	36		8886443671
		1	4	40	100	BLUE	12		CPB-738G

Surgipro™ II and Surgipro™ 7-0, 8-0; Sofsilik™ 8-0; Polysorb™, Biosyn™, Monosof™, Maxon™, Velosorb™ Fast sutures differ from USP and EP only in diameter. Please refer to IFU for more details.

© 2018 Medtronic. All rights reserved. Medtronic, Medtronic logo and Further, Together are trademarks of Medtronic.







™*Third party brands are trademarks of their respective owners.

All other brands are trademarks of a Medtronic company.

11/2018 US170542

NOVAFIL™

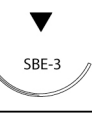
Monofilament Polybutester Non-Absorbable Sutures

PREMIUM REVERSE CUTTING									
Description	USP Size	EP Size	Length (in)	Length (cm)	Color	Units per box	Comments	Reorder code	
P-10 3/8 CIRCLE 11mm 	7-0	0.5	18		BLUE	12	Edgellant™ needle, Surgalloy™ alloy	8886441003	
	6-0	0.7	18		BLUE	12	Edgellant™ needle, Surgalloy™ alloy	8886441013	
	5-0	1	18		BLUE	12	Edgellant™ needle, Surgalloy™ alloy	8886441023	
P-13 3/8 CIRCLE 13mm 	6-0	0.7	18	45	BLUE	12	Edgellant™ needle, Surgalloy™ alloy	SPB-1213G	
	5-0	1	30		BLUE	36	Edgellant™ needle, Surgalloy™ alloy	8886402721	
	5-0	1	18	45	BLUE	12	Edgellant™ needle, Surgalloy™ alloy	SPB-5223G	
	4-0	1.5	18	45	BLUE	12	Edgellant™ needle, Surgalloy™ alloy	SPB-1233G	
SBE-2 3/8 CIRCLE 13mm 	6-0	0.7	18	45	BLUE	12		8886440013	
	5-0	1	18	45	BLUE	12		8886440023	
P-11 3/8 CIRCLE 16mm 	6-0	0.7	18	45	BLUE	12	Edgellant™ needle, Surgalloy™ alloy	SPB-5413G	
	5-0	1	30		BLUE	36	Edgellant™ needle, Surgalloy™ alloy	8886402821	
	5-0	1	18		BLUE	12	Edgellant™ needle, Surgalloy™ alloy	SPB5142G	
	4-0	1.5	30		BLUE	36	Edgellant™ needle, Surgalloy™ alloy	8886402831	
	4-0	1.5	18		BLUE	36	Edgellant™ needle, Surgalloy™ alloy	8886441431	
	4-0	1.5	18	45	BLUE	12	Edgellant™ needle, Surgalloy™ alloy	SPB-5143G	
SBE-3 3/8 CIRCLE 16mm 	6-0	0.7	18	45	BLUE	12		8886440113	
	5-0	1	18	45	BLUE	12		8886440123	
	4-0	1.5	18	45	BLUE	12		8886440133	
P-12 3/8 CIRCLE 19mm 	5-0	1	18	45	BLUE	12	Edgellant™ needle, Surgalloy™ alloy	SPB-1623G	
	4-0	1.5	30		BLUE	36	Edgellant™ needle, Surgalloy™ alloy	8886442531	
	4-0	1.5	18	45	BLUE	12	Edgellant™ needle, Surgalloy™ alloy	SPB-5633G	
	3-0	2	18		BLUE	36	Edgellant™ needle, Surgalloy™ alloy	8886441543	
	3-0	2	18	45	BLUE	12	Edgellant™ needle, Surgalloy™ alloy	SPB-1643G	
SBE-4 3/8 CIRCLE 19mm 	5-0	1	18	45	BLUE	12		8886440223	
	4-0	1.5	18	45	BLUE	12		8886440233	
	3-0	2	18	45	BLUE	12		8886440243	

Surgipro™ II and Surgipro™ 7-0, 8-0; Sofsilik™ 8-0; Polysorb™, Biosyn™, Monosof™, Maxon™, Velosorb™ Fast sutures differ from USP and EP only in diameter. Please refer to IFU for more details.

© 2018 Medtronic. All rights reserved. Medtronic, Medtronic logo and Further, Together are trademarks of Medtronic.



™*Third party brands are trademarks of their respective owners.

All other brands are trademarks of a Medtronic company.

11/2018 US170542

NOVAFIL™

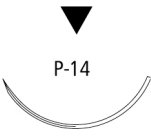
Monofilament Polybutester Non-Absorbable Sutures

PREMIUM REVERSE CUTTING									
Description	USP Size	EP Size	Length (in)	Length (cm)	Color	Units per box	Comments	Reorder code	
P-14 3/8 CIRCLE 24mm 	4-0	1.5	18	45	BLUE	12	Edgellant™ needle, Surgalloy™ alloy	SPB-5833G	
	3-0	2	18	45	BLUE	12	Edgellant™ needle, Surgalloy™ alloy	SPB-5843G	
	3-0	2	30	75	BLUE	36	Edgellant™ needle, Surgalloy™ alloy	88864582-43	
	2-0	3	18		BLUE	12	Edgellant™ needle, Surgalloy™ alloy	8886441853	
	2-0	3	30	75	BLUE	36	Surgalloy™	88864582-53	
SBE-6 3/8 CIRCLE 24mm 	4-0	1.5	18	45	BLUE	12		8886440333	
	3-0	2	18	45	BLUE	12		8886440343	
P-24 1/2 CIRCLE 16mm 	4-0	1.5	18	45	CLEAR	12	Edgellant™ needle, Surgalloy™ alloy	SPB-5433G	

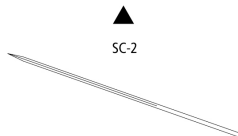
CONVENTIONAL CUTTING									
Description	USP Size	EP Size	Length (in)	Length (cm)	Color	Units per box	Comments	Reorder code	
SC-2 STRAIGHT 60mm (Not to scale) 	3-0	2	30	75	BLUE	36		88864490-41	
	2-0	3	30	75	BLUE	36		88864490-51	

Surgipro™ II and Surgipro™ 7-0, 8-0; Sofsilik™ 8-0; Polysorb™, Biosyn™, Monosof™, Maxon™, Velosorb™ Fast sutures differ from USP and EP only in diameter. Please refer to IFU for more details.

© 2018 Medtronic. All rights reserved. Medtronic, Medtronic logo and Further, Together are trademarks of Medtronic.







™*Third party brands are trademarks of their respective owners.

All other brands are trademarks of a Medtronic company.

11/2018 US170542

NOVAFIL™

Monofilament Polybutester Non-Absorbable Sutures

DERMAX PREMIUM X CUTTING									
Description		USP Size	EP Size	Length (in)	Length (cm)	Color	Units per box	Comments	Reorder code
DX-11 3/8 CIRCLE 11mm	 DX-11 	6-0	0.7	18	45	BLUE	12	DermaX	XNF-697
DX-16 3/8 CIRCLE 16mm	 DX-16 	6-0	0.7	18	45	BLUE	12	DermaX	XNF-1966
		5-0	1	18	45	BLUE	12	DermaX	XNF-1965
		4-0	1.5	18	45	BLUE	12	DermaX	XNF-1964
DX-19 3/8 CIRCLE 19mm	 DX-19 	5-0	1	18	45	BLUE	12	DermaX	XNF-1995
		4-0	1.5	18	45	BLUE	12	DermaX	XNF-1994
		3-0	2	18	45	BLUE	12	DermaX	XNF-1993

Surgipro™ II and Surgipro™ 7-0, 8-0; Sofsilik™ 8-0; Polysorb™, Biosyn™, Monosof™, Maxon™, Velosorb™ Fast sutures differ from USP and EP only in diameter. Please refer to IFU for more details.







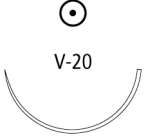

© 2018 Medtronic. All rights reserved. Medtronic, Medtronic logo and Further, Together are trademarks of Medtronic.

™*Third party brands are trademarks of their respective owners.

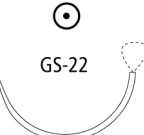
All other brands are trademarks of a Medtronic company.

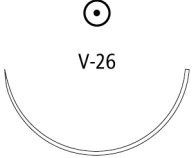
11/2018 US170542

Monofilament Polybutester Non-Absorbable Sutures

TAPER POINT									
Description		USP Size	EP Size	Length (in)	Length (cm)	Color	Units per box	Comments	Reorder code
V-20 1/2 CIRCLE 26mm		3-0	2	30	75	BLUE	36	Surgalloy™	8886445241
		2-0	3	30	75	BLUE	36	Surgalloy™	8886445251
		0	3.5	30	75	BLUE	36	Surgalloy™	8886445261
GS-22 1/2 CIRCLE 27mm		2-0	3	18	45	BLUE	12	5 strands, D-Tach™	8886445853
		2-0	3	30	75	BLUE	36		8886445951
		0	3.5	18	45	BLUE	12	5 strands, D-Tach™	8886445863
		0	3.5	30	75	BLUE	36		8886445961
		1	4	30	75	BLUE	36		8886445971
GS-22 LOOP 1/2 CIRCLE 27mm		2-0	3	60	150	BLUE	36		88864619-51
GS-21 1/2 CIRCLE 37mm		0	3.5	18	45	BLUE	12	5 strands, D-Tach™	8886445463
		0	3.5	30	75	BLUE	36		8886445561
		1	4	18	45	BLUE	12	5 strands, D-Tach™	8886445473
		1	4	30	75	BLUE	36		8886445571
V-26 1/2 CIRCLE 37mm		3-0	2	30	75	BLUE	36		8886445041
GS-24 1/2 CIRCLE 40mm		1	4	30	75	BLUE	36		88864463-71
GS-25 1/2 CIRCLE 48mm (Not to scale)		2	5	30	75	BLUE	36		88864465-81
		1	4	18	45	BLUE	12	5 strands, D-Tach™	88864464-73
		1	4	30	75	BLUE	36		88864465-71
GS-25 LOOP 1/2 CIRCLE 48mm (Not to scale)		0	3.5	80	200	BLUE	12		88864538-63

Surgipro™ II and Surgipro™ 7-0, 8-0; Sofsilik™ 8-0; Polysorb™, Biosyn™, Monosof™, Maxon™, Velosorb™ Fast sutures differ from USP and EP only in diameter. Please refer to IFU for more details.

© 2018 Medtronic. All rights reserved. Medtronic, Medtronic logo and Further, Together are trademarks of Medtronic.

™*Third party brands are trademarks of their respective owners.

All other brands are trademarks of a Medtronic company.

11/2018 US170542

NOVAFIL™

Monofilament Polybutester Non-Absorbable Sutures

TAPER POINT									
Description	USP Size	EP Size	Length (in)	Length (cm)	Color	Units per box	Comments	Reorder code	
GS-26 1/2 CIRCLE 65mm (Not to scale)	2	5	60	150	BLUE	36		88864470-81	
	1	4	60	150	BLUE	36		88864470-71	
GS-26 LOOP 1/2 CIRCLE 65mm (Not to scale)	0	3.5	60	150	BLUE	36	Loop	8886440861	

HEAVY TAPER POINT									
Description	USP Size	EP Size	Length (in)	Length (cm)	Color	Units per box	Comments	Reorder code	
HGS-22 1/2 CIRCLE 27mm	0	3.5	18	45	BLUE	12	5 strands, D-Tach™	8886446063	
	0	3.5	30	75	BLUE	36		88864469-61	
	1	4	30	75	BLUE	36		88864469-71	

PREMIUM SPATULA									
Description	USP Size	EP Size	Length (in)	Length (cm)	Color	Units per box	Comments	Reorder code	
SS-1 - SS-1 1/6 CIRCLE (Double armed)	5-0	1	12	30	BLUE			PB-7740K	
SS-24 - SS-24 1/4 CIRCLE 8.6mm (Double armed)	6-0	0.7	12	30	BLUE	12	Surgalloy™	PB-6713K	
	5-0	1	12	30	BLUE	12	Surgalloy™	PB-6723K	

Surgipro™ II and Surgipro™ 7-0, 8-0; Sofsilik™ 8-0; Polysorb™, Biosyn™, Monosof™, Maxon™, Velosorb™ Fast sutures differ from USP and EP only in diameter. Please refer to IFU for more details.

© 2018 Medtronic. All rights reserved. Medtronic, Medtronic logo and Further, Together are trademarks of Medtronic.

™*Third party brands are trademarks of their respective owners.

All other brands are trademarks of a Medtronic company.

11/2018 US170542

NOVAFIL™

Monofilament Polybutester Non-Absorbable Sutures

Reorder Code	Page	Reorder Code	Page	Reorder Code	Page
<u>8886400241</u>	<u>197</u>	<u>8886442641</u>	<u>197</u>	<u>SPB-1213G</u>	<u>198</u>
<u>8886400963</u>	<u>197</u>	<u>8886442651</u>	<u>197</u>	<u>SPB-1233G</u>	<u>198</u>
<u>8886402721</u>	<u>198</u>	<u>8886442661</u>	<u>197</u>	<u>SPB-1623G</u>	<u>198</u>
<u>8886402821</u>	<u>198</u>	<u>8886443371</u>	<u>197</u>	<u>SPB-1643G</u>	<u>198</u>
<u>8886402831</u>	<u>198</u>	<u>8886443671</u>	<u>197</u>	<u>SPB5142G</u>	<u>198</u>
<u>8886403231</u>	<u>197</u>	<u>8886445041</u>	<u>201</u>	<u>SPB-5143G</u>	<u>198</u>
<u>8886440013</u>	<u>198</u>	<u>8886445241</u>	<u>201</u>	<u>SPB-5223G</u>	<u>198</u>
<u>8886440023</u>	<u>198</u>	<u>8886445251</u>	<u>201</u>	<u>SPB-5413G</u>	<u>198</u>
<u>8886440113</u>	<u>198</u>	<u>8886445261</u>	<u>201</u>	<u>SPB-5433G</u>	<u>199</u>
<u>8886440123</u>	<u>198</u>	<u>8886445463</u>	<u>201</u>	<u>SPB-5633G</u>	<u>198</u>
<u>8886440133</u>	<u>198</u>	<u>8886445473</u>	<u>201</u>	<u>SPB-5833G</u>	<u>199</u>
<u>8886440223</u>	<u>198</u>	<u>8886445561</u>	<u>201</u>	<u>SPB-5843G</u>	<u>199</u>
<u>8886440233</u>	<u>198</u>	<u>8886445571</u>	<u>201</u>	<u>XNF-1964</u>	<u>200</u>
<u>8886440243</u>	<u>198</u>	<u>8886445853</u>	<u>201</u>	<u>XNF-1965</u>	<u>200</u>
<u>8886440333</u>	<u>199</u>	<u>8886445863</u>	<u>201</u>	<u>XNF-1966</u>	<u>200</u>
<u>8886440343</u>	<u>199</u>	<u>8886445951</u>	<u>201</u>	<u>XNF-1993</u>	<u>200</u>
<u>8886440861</u>	<u>202</u>	<u>8886445961</u>	<u>201</u>	<u>XNF-1994</u>	<u>200</u>
<u>8886441003</u>	<u>198</u>	<u>8886445971</u>	<u>201</u>	<u>XNF-1995</u>	<u>200</u>
<u>8886441013</u>	<u>198</u>	<u>8886446063</u>	<u>202</u>	<u>XNF-697</u>	<u>200</u>
<u>8886441023</u>	<u>198</u>	<u>88864463-71</u>	<u>201</u>		
<u>8886441431</u>	<u>198</u>	<u>88864464-73</u>	<u>201</u>		
<u>8886441543</u>	<u>198</u>	<u>88864465-71</u>	<u>201</u>		
<u>8886441853</u>	<u>199</u>	<u>88864465-81</u>	<u>201</u>		
<u>8886441913</u>	<u>197</u>	<u>88864469-61</u>	<u>202</u>		
<u>8886441923</u>	<u>197</u>	<u>88864469-71</u>	<u>202</u>		
<u>8886441933</u>	<u>197</u>	<u>88864470-71</u>	<u>202</u>		
<u>8886442013</u>	<u>197</u>	<u>88864470-81</u>	<u>202</u>		
<u>8886442023</u>	<u>197</u>	<u>88864490-41</u>	<u>199</u>		
<u>8886442033</u>	<u>197</u>	<u>88864490-51</u>	<u>199</u>		
<u>8886442043</u>	<u>197</u>	<u>88864538-63</u>	<u>201</u>		
<u>8886442153</u>	<u>197</u>	<u>88864554-41</u>	<u>197</u>		
<u>8886442233</u>	<u>197</u>	<u>88864555-23</u>	<u>197</u>		
<u>8886442243</u>	<u>197</u>	<u>88864582-43</u>	<u>199</u>		
<u>8886442253</u>	<u>197</u>	<u>88864582-53</u>	<u>199</u>		
<u>8886442431</u>	<u>197</u>	<u>88864619-51</u>	<u>201</u>		
<u>8886442441</u>	<u>197</u>	<u>CPB-738G</u>	<u>197</u>		
<u>8886442451</u>	<u>197</u>	<u>PB-6713K</u>	<u>202</u>		
<u>8886442461</u>	<u>197</u>	<u>PB-6723K</u>	<u>202</u>		
<u>8886442531</u>	<u>198</u>	<u>PB-7740K</u>	<u>202</u>		

Surgipro™ II and Surgipro™ 7-0, 8-0; Sofsilik™ 8-0; Polysorb™, Biosyn™, Monosof™, Maxon™, Velosorb™ Fast sutures differ from USP and EP only in diameter. Please refer to IFU for more details.

© 2018 Medtronic. All rights reserved. Medtronic, Medtronic logo and Further, Together are trademarks of Medtronic.

™*Third party brands are trademarks of their respective owners.

All other brands are trademarks of a Medtronic company.

11/2018 US170542

SURGILON™

Coated, Braided Polyamide Non-Absorbable Sutures

Description	SURGILON™ braided sutures are inert, nonabsorbable, sterile sutures composed of the long-chain aliphatic polymers Nylon 6 and Nylon 6.6. The braided sutures are coated uniformly with silicone to enhance handling characteristics, ease of passage through tissue and reduction of capillarity.
Indications	SURGILON™ braided nylon sutures are indicated for use in general soft tissue approximation and/or ligation, including use in cardiovascular, ophthalmic, and neurological surgery
Actions	SURGILON™ braided nylon sutures all elicit a minimal acute inflammatory reaction in tissue, which is followed by gradual encapsulation of the suture by fibrous connective tissue.
Tensile Strength	As with any nylon suture, though not absorbed, progressive hydrolysis of the suture, in vivo, may result in gradual loss of its tensile strength over time.
Sterilization	Surgilon™ braided nylon sutures are sterilized by ethylene oxide in sizes 6-0 (0.7 metric) and smaller and by gamma irradiation in sizes 2 (5 metric) through 5-0 (1 metric).
Packaging	SURGILON™ braided nylon sutures are available dyed black in sizes 3 (6 Metric) through 5-0 (1 Metric). The sutures are supplied sterile, in pre-cut lengths or affixed to needles using both permanent and removable needle attachment techniques. Please refer to the individual package IFUs for complete instructions, indications, contraindications, warnings and precautions.

SURGILON™

Coated, Braided Polyamide Non-Absorbable Sutures

NON NEEDLED - PRE-CUT								
Description	USP Size	EP Size	Length (in)	Length (cm)	Color	Units per box	Comments	Reorder code
PRE-CUT	4-0	1.5	18	45	BLACK	36	12 strands	88861918-31
	4-0	1.5	30	75	BLACK	36	7 strands	88861919-31
	3-0	2	18	45	BLACK	36	12 strands	88861918-41
	3-0	2	18	45	WHITE	36	12 strands	88861899-41
	3-0	2	30	75	BLACK	36	7 strands	88861919-41
	2-0	3	18	45	BLACK	36	12 strands	88861918-51
	2-0	3	18	45	WHITE	36	12 strands	88861899-51
	2-0	3	30	75	BLACK	36	7 strands	88861919-51
	0	3.5	18	45	BLACK	36	6 strands	88861917-61
	0	3.5	18	45	WHITE	36	6 strands	88861902-61
	0	3.5	30	75	BLACK	36	7 strands	88861919-61
	2	5	18	45	BLACK	24	6 strands	88861917-82
	1	4	18	45	WHITE	36	6 strands	88861902-71
	1	4	18	45	BLACK	36	6 strands	88861917-71
1	4	30	75	BLACK	36	7 strands	88861919-71	

NON NEEDLED - REEL								
Description	USP Size	EP Size	Length (in)	Length (cm)	Color	Units per box	Comments	Reorder code
REEL	3-0	2	144	366	BLACK	24		88861906-42
	2-0	3	144	366	BLACK	24		88861906-52
	0	3.5	98	250	BLACK	24		88861920-62
	2	5	120	300	BLACK	12		88861914-83
	3&4	6	95	238	BLACK	12		88861920-93
	1	4	98	250	BLACK	24		88861920-72

Surgipro™ II and Surgipro™ 7-0, 8-0; Sofsilik™ 8-0; Polysorb™, Biosyn™, Monosof™, Maxon™, Velosorb™ Fast sutures differ from USP and EP only in diameter. Please refer to IFU for more details.

© 2018 Medtronic. All rights reserved. Medtronic, Medtronic logo and Further, Together are trademarks of Medtronic.



™*Third party brands are trademarks of their respective owners.

All other brands are trademarks of a Medtronic company.

11/2018 US170542

SURGILON™

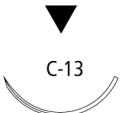
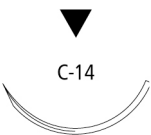
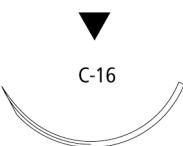
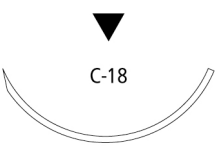
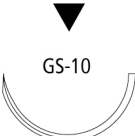
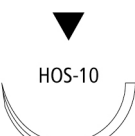
Coated, Braided Polyamide Non-Absorbable Sutures

REVERSE CUTTING									
Description	USP Size	EP Size	Length (in)	Length (cm)	Color	Units per box	Comments	Reorder code	
C-13 3/8 CIRCLE 19mm 	3-0	2	18	45	BLACK	12	Reliapoint™needle	88861931-43	
	2-0	3	30	75	BLACK	36		88861982-51	
C-14 3/8 CIRCLE 24mm 	3-0	2	30	75	BLACK	36	Reliapoint™needle	88861935-41	
	2-0	3	18	45	BLACK	12	Reliapoint™needle	88861934-53	
	2-0	3	30	75	BLACK	36	Reliapoint™needle	88861935-51	
	0	3.5	30	75	BLACK	36	Reliapoint™needle	88861935-61	
C-16 3/8 CIRCLE 30mm 	3-0	2	18	45	BLACK	24	5 strands, D-Tach™, Reliapoint™needle	88861991-42	
	2-0	3	30	75	BLACK	36	Reliapoint™needle	88861883-51	
	0	3.5	30	75	BLACK	36	Reliapoint™needle	88861883-61	
	1	4	30	75	BLACK	36	Reliapoint™needle	88861883-71	
C-18 3/8 CIRCLE 35mm 	1	4	30	75	BLACK	36	Reliapoint™needle	88861922-71	
GS-10 1/2 CIRCLE 26mm 	2-0	3	30	75	BLACK	36		88861932-51	
HOS-10 1/2 CIRCLE 26mm 	1	4	30	75	BLACK	36		88861896-71	
GS-11 1/2 CIRCLE 37mm 	0	3.5	30	75	BLACK	36		88861915-61	
	1	4	30	75	BLACK	36		88861915-71	
HOS-12 1/2 CIRCLE 40mm 	1	4	18	45	BLACK	24	5 strands, D-Tach™	88861913-72	
	1	4	30	75	BLACK	36		88861895-71	

Surgipro™ II and Surgipro™ 7-0, 8-0; Sofsilik™ 8-0; Polysorb™, Biosyn™, Monosof™, Maxon™, Velosorb™ Fast sutures differ from USP and EP only in diameter. Please refer to IFU for more details.

© 2018 Medtronic. All rights reserved. Medtronic, Medtronic logo and Further, Together are trademarks of Medtronic.



™*Third party brands are trademarks of their respective owners.

All other brands are trademarks of a Medtronic company.

11/2018 US170542

SURGILON™

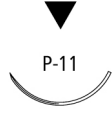
Coated, Braided Polyamide Non-Absorbable Sutures

PREMIUM REVERSE CUTTING									
Description	USP Size	EP Size	Length (in)	Length (cm)	Color	Units per box	Comments	Reorder code	
P-13 3/8 CIRCLE 13mm 	5-0	1	18	45	BLACK	12	Edgellant™ needle, Surgalloy™ alloy	SBS-1928G	
	4-0	1.5	18	45	WHITE	12	Edgellant™ needle, Surgalloy™ alloy	SBS-1880G	
P-11 3/8 CIRCLE 16mm 	4-0	1.5	18	45	BLACK	12	Surgalloy™	88861981-33	
P-12 3/8 CIRCLE 19mm 	4-0	1.5	18	45	WHITE	12	Edgellant™ needle, Surgalloy™ alloy	SBS-1884G	
	3-0	2	18	45	WHITE	12	Edgellant™ needle, Surgalloy™ alloy	SBS-1883G	

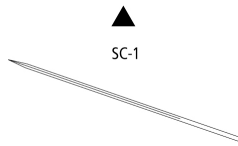
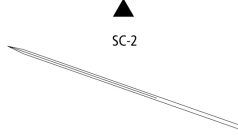
CONVENTIONAL CUTTING									
Description	USP Size	EP Size	Length (in)	Length (cm)	Color	Units per box	Comments	Reorder code	
SC-1 STRAIGHT 51mm (Not to scale) 	2-0	3	30	75	BLACK	36		88861985-51	
	0	3.5	30	75	BLACK	36		88861985-61	
	1	4	30	75	BLACK	36		88861985-71	
SC-2 STRAIGHT 60mm (Not to scale) 	0	3.5	30	75	BLACK	36		88861948-61	
	2	5	30	75	BLACK	36		88861948-81	

Surgipro™ II and Surgipro™ 7-0, 8-0; Sofsilik™ 8-0; Polysorb™, Biosyn™, Monosof™, Maxon™, Velosorb™ Fast sutures differ from USP and EP only in diameter. Please refer to IFU for more details.

© 2018 Medtronic. All rights reserved. Medtronic, Medtronic logo and Further, Together are trademarks of Medtronic.







™*Third party brands are trademarks of their respective owners.

All other brands are trademarks of a Medtronic company.

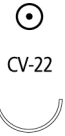
11/2018 US170542

SURGILON™

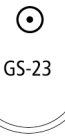
Coated, Braided Polyamide Non-Absorbable Sutures

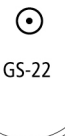
TAPER POINT									
Description		USP Size	EP Size	Length (in)	Length (cm)	Color	Units per box	Comments	Reorder code
CV-20 1/2 CIRCLE 10mm		5-0	1	18	45	BLACK	24	5 strands, D-Tach™	88861910-22
		4-0	1.5	18	45	BLACK	24	5 strands, D-Tach™	88861910-32
CV-22 1/2 CIRCLE 13mm		4-0	1.5	18	45	BLACK	24	5 strands, D-Tach™	88861953-32J
		4-0	1.5	18	45	BLACK	24	5 strands, D-Tach™	88861957-32
CV-23 1/2 CIRCLE 17mm		4-0	1.5	18	45	BLACK	24	5 strands, D-Tach™	88861927-32
		4-0	1.5	18	45	BLACK	24	5 strands, D-Tach™	88861954-32J
		4-0	1.5	30	75	BLACK	36		88861995-31
		3-0	2	18	45	BLACK	24	5 strands, D-Tach™	88861927-42
		3-0	2	30	75	BLACK	36		88861995-41
CV-24 1/2 CIRCLE 20mm		4-0	1.5	18	45	BLACK	24	5 strands, D-Tach™	88861989-32
		3-0	2	18	45	BLACK	24	5 strands, D-Tach™	88861989-42
CV-25 1/2 CIRCLE 22mm		3-0	2	18	45	BLACK	24	5 strands, D-Tach™	88861990-42J
GS-23 1/2 CIRCLE 22mm		0	3.5	18	45	BLACK	24	5 strands, D-Tach™	88861993-62
V-20 1/2 CIRCLE 26mm		3-0	2	18	45	BLACK	24	5 strands, D-Tach™	88861958-42
		3-0	2	30	75	BLACK	36		88861951-41
		3-0	2	30	75	BLACK	24	5 strands, D-Tach™	88861926-42
		2-0	3	18	45	BLACK	24	5 strands, D-Tach™	88861958-52
		2-0	3	30	75	BLACK	24	5 strands, D-Tach™	88861967-52
		2-0	3	30	75	BLACK	36		88861951-51
		0	3.5	30	75	BLACK	36		88861951-61
GS-22 1/2 CIRCLE 27mm		2-0	3	18	45	BLACK	24	5 strands, D-Tach™	88861969-52
		0	3.5	18	45	BLACK	24	5 strands, D-Tach™	88861969-62
		0	3.5	30	75	BLACK	36		88861968-61
		1	4	18	45	BLACK	24	5 strands, D-Tach™	88861969-72

Surgipro™ II and Surgipro™ 7-0, 8-0; Sofsilik™ 8-0; Polysorb™, Biosyn™, Monosof™, Maxon™, Velosorb™ Fast sutures differ from USP and EP only in diameter. Please refer to IFU for more details.

© 2018 Medtronic. All rights reserved. Medtronic, Medtronic logo and Further, Together are trademarks of Medtronic.



™*Third party brands are trademarks of their respective owners.

All other brands are trademarks of a Medtronic company.

11/2018 US170542

SURGILON™

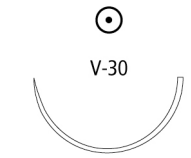
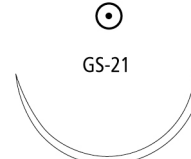
Coated, Braided Polyamide Non-Absorbable Sutures

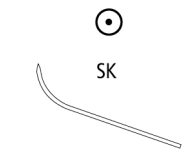
TAPER POINT									
Description	USP Size	EP Size	Length (in)	Length (cm)	Color	Units per box	Comments	Reorder code	
V-30 1/2 CIRCLE 30mm	2-0	3	30	75	BLACK	36		88861964-51	
	0	3.5	30	75	BLACK	36		88861964-61	
GS-21 1/2 CIRCLE 37mm	2-0	3	18	45	BLACK	24	5 strands, D-Tach™	88861962-52	
	0	3.5	18	45	BLACK	24	5 strands, D-Tach™	88861962-62	
	0	3.5	30	75	BLACK	36		88861971-61	
	1	4	18	45	BLACK	24	5 strands, D-Tach™	88861962-72	
GS-25 1/2 CIRCLE 48mm (Not to scale)	0	3.5	18	45	BLACK	24	5 strands, D-Tach™	88861998-62	
	1	4	18	45	BLACK	24	5 strands, D-Tach™	8886199872	
SK SKI 23mm	2-0	3	98	250	BLACK	36		88862011-51	

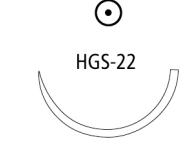
HEAVY TAPER POINT									
Description	USP Size	EP Size	Length (in)	Length (cm)	Color	Units per box	Comments	Reorder code	
HGS-22 1/2 CIRCLE 27mm	0	3.5	18	45	BLACK	24	5 strands, D-Tach™	88861928-62	
	1	4	18	45	BLACK	24	5 strands, D-Tach™	88861928-72	

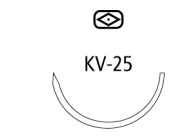
DIAMOND POINT									
Description	USP Size	EP Size	Length (in)	Length (cm)	Color	Units per box	Comments	Reorder code	
KV-25 1/2 CIRCLE 22mm	0	3.5	18	45	BLACK	24	5 strands, D-Tach™	88861909-62	

Surgipro™ II and Surgipro™ 7-0, 8-0; Sofsilik™ 8-0; Polysorb™, Biosyn™, Monosof™, Maxon™, Velosorb™ Fast sutures differ from USP and EP only in diameter. Please refer to IFU for more details.

© 2018 Medtronic. All rights reserved. Medtronic, Medtronic logo and Further, Together are trademarks of Medtronic.

™*Third party brands are trademarks of their respective owners.

All other brands are trademarks of a Medtronic company.

11/2018 US170542

SURGILON™

Coated, Braided Polyamide Non-Absorbable Sutures

Reorder Code	Page	Reorder Code	Page	Reorder Code	Page
<u>88861883-51</u>	<u>208</u>	<u>88861932-51</u>	<u>208</u>	<u>88861998-62</u>	<u>211</u>
<u>88861883-61</u>	<u>208</u>	<u>88861934-53</u>	<u>208</u>	<u>8886199872</u>	<u>211</u>
<u>88861883-71</u>	<u>208</u>	<u>88861935-41</u>	<u>208</u>	<u>88862011-51</u>	<u>211</u>
<u>88861895-71</u>	<u>208</u>	<u>88861935-51</u>	<u>208</u>	<u>SBS-1880G</u>	<u>209</u>
<u>88861896-71</u>	<u>208</u>	<u>88861935-61</u>	<u>208</u>	<u>SBS-1883G</u>	<u>209</u>
<u>88861899-41</u>	<u>207</u>	<u>88861948-61</u>	<u>209</u>	<u>SBS-1884G</u>	<u>209</u>
<u>88861899-51</u>	<u>207</u>	<u>88861948-81</u>	<u>209</u>	<u>SBS-1928G</u>	<u>209</u>
<u>88861902-61</u>	<u>207</u>	<u>88861951-41</u>	<u>210</u>		
<u>88861902-71</u>	<u>207</u>	<u>88861951-51</u>	<u>210</u>		
<u>88861906-42</u>	<u>207</u>	<u>88861951-61</u>	<u>210</u>		
<u>88861906-52</u>	<u>207</u>	<u>88861953-32J</u>	<u>210</u>		
<u>88861909-62</u>	<u>211</u>	<u>88861954-32J</u>	<u>210</u>		
<u>88861910-22</u>	<u>210</u>	<u>88861957-32</u>	<u>210</u>		
<u>88861910-32</u>	<u>210</u>	<u>88861958-42</u>	<u>210</u>		
<u>88861913-72</u>	<u>208</u>	<u>88861958-52</u>	<u>210</u>		
<u>88861914-83</u>	<u>207</u>	<u>88861962-52</u>	<u>211</u>		
<u>88861915-61</u>	<u>208</u>	<u>88861962-62</u>	<u>211</u>		
<u>88861915-71</u>	<u>208</u>	<u>88861962-72</u>	<u>211</u>		
<u>88861917-61</u>	<u>207</u>	<u>88861964-51</u>	<u>211</u>		
<u>88861917-71</u>	<u>207</u>	<u>88861964-61</u>	<u>211</u>		
<u>88861917-82</u>	<u>207</u>	<u>88861967-52</u>	<u>210</u>		
<u>88861918-31</u>	<u>207</u>	<u>88861968-61</u>	<u>210</u>		
<u>88861918-41</u>	<u>207</u>	<u>88861969-52</u>	<u>210</u>		
<u>88861918-51</u>	<u>207</u>	<u>88861969-62</u>	<u>210</u>		
<u>88861919-31</u>	<u>207</u>	<u>88861969-72</u>	<u>210</u>		
<u>88861919-41</u>	<u>207</u>	<u>88861971-61</u>	<u>211</u>		
<u>88861919-51</u>	<u>207</u>	<u>88861971-71</u>	<u>211</u>		
<u>88861919-61</u>	<u>207</u>	<u>88861981-33</u>	<u>209</u>		
<u>88861919-71</u>	<u>207</u>	<u>88861982-51</u>	<u>208</u>		
<u>88861920-62</u>	<u>207</u>	<u>88861985-51</u>	<u>209</u>		
<u>88861920-72</u>	<u>207</u>	<u>88861985-61</u>	<u>209</u>		
<u>88861920-93</u>	<u>207</u>	<u>88861985-71</u>	<u>209</u>		
<u>88861922-71</u>	<u>208</u>	<u>88861989-32</u>	<u>210</u>		
<u>88861926-42</u>	<u>210</u>	<u>88861989-42</u>	<u>210</u>		
<u>88861927-32</u>	<u>210</u>	<u>88861990-42J</u>	<u>210</u>		
<u>88861927-42</u>	<u>210</u>	<u>88861991-42</u>	<u>208</u>		
<u>88861928-62</u>	<u>211</u>	<u>88861993-62</u>	<u>210</u>		
<u>88861928-72</u>	<u>211</u>	<u>88861995-31</u>	<u>210</u>		
<u>88861931-43</u>	<u>208</u>	<u>88861995-41</u>	<u>210</u>		

Surgipro™ II and Surgipro™ 7-0, 8-0; Sofsilik™ 8-0; Polysorb™, Biosyn™, Monosof™, Maxon™, Velosorb™ Fast sutures differ from USP and EP only in diameter. Please refer to IFU for more details.

© 2018 Medtronic. All rights reserved. Medtronic, Medtronic logo and Further, Together are trademarks of Medtronic.

™*Third party brands are trademarks of their respective owners.

All other brands are trademarks of a Medtronic company.

11/2018 US170542

SOFSILK™

Coated, Braided Silk Non-Absorbable Sutures

Description	Sofsilk™ braided silk sutures are nonabsorbable, sterile, non-mutagenic surgical sutures composed of natural proteinaceous silk fibers called fibroin. This protein is derived from the domesticated silkworm species <i>Bombyx mori</i> of the family bombycidae. The silk fibers are treated to remove the naturally-occurring sericin gum and braided to produce Sof silk™ surgical silk sutures. The braided sutures are available coated uniformly with either silicone or a special wax mixture to reduce capillarity and to increase surface lubricity which enhances handling characteristics, ease of passage through tissue, and knot run-down properties.
Indications	Sofsilk™ sutures are indicated for use in general soft tissue approximation and/or ligation, including use in cardiovascular, ophthalmic, microsurgery, and neurological surgery.
Actions	Sofsilk™ sutures elicit a minimal acute inflammatory reaction in tissue, which is followed by gradual encapsulation of the suture by fibrous connective tissue.
Tensile Strength	While Sof silk™ sutures are not absorbed, progressive degradation of the proteinaceous silk fiber in vivo may result in gradual loss of the suture's tensile strength over time.
Sterilization	Gamma irradiation.
Packaging	Sofsilk™ sutures are available in black with Logwood extract and uniformly coated with silicone or a special wax mixture, in sizes 5 (7 Metric) through 8-0 (0.4 Metric). The sutures are supplied sterile, in pre-cut lengths and ligating reels, nonneedled or affixed to needles using both permanent and removable needle attachment techniques. Please refer to the individual package IFUs for complete instructions, indications, contraindications, warnings and precautions.

SOFSILK™

Coated, Braided Silk Non-Absorbable Sutures

NON NEEDED - PRE-CUT								
Description	USP Size	EP Size	Length (in)	Length (cm)	Color	Units per box	Comments	Reorder code
PRE-CUT	5-0	1	18	45	BLACK	36	12 strands	S-182
	4-0	1.5	18	45	BLACK	36	12 strands	S-183
	4-0	1.5	18	45	BLACK	24	12 strands	S-193
	4-0	1.5	24	60	BLACK	36	12 strands	S-243
	4-0	1.5	30	75	BLACK	24	12 strands	S-403
	4-0	1.5	30	75	BLACK	36	12 strands	S-303
	3-0	2	18	45	BLACK	24	12 strands	S-194
	3-0	2	18	45	BLACK	36	12 strands	S-184
	3-0	2	24	60	BLACK	36	12 strands	S-244
	3-0	2	24	60	BLACK	24	12 strands	S-254
	3-0	2	30	75	BLACK	24	12 strands	S-404
	3-0	2	30	75	BLACK	36	12 strands	S-304
	2-0	3	18	45	BLACK	24	12 strands	S-195
	2-0	3	18	45	BLACK	36	12 strands	S-185
	2-0	3	24	60	BLACK	24	12 strands	S-255
	2-0	3	24	60	BLACK	36	12 strands	S-245
	2-0	3	30	75	BLACK	24	12 strands	S-405
	2-0	3	30	75	BLACK	36	12 strands	S-305
	2-0	3	60	150	BLACK	36	2 strands	S-605
	0	3.5	18	45	BLACK	24	6 strands	S-196
	0	3.5	18	45	BLACK	24	12 strands	S-176
	0	3.5	24	60	BLACK	24	12 strands	S-346
	0	3.5	24	60	BLACK	36	6 strands	S-246
	0	3.5	30	75	BLACK	24	12 strands	S-316
	0	3.5	60	150	BLACK	36	2 strands	S-606
	2	5	30	75	BLACK	24	12 strands	S-318
	2	5	60	150	BLACK	36	2 strands	S-608
	5	7	24	60	BLACK	36	3 strands	S-282
	5	7	60	150	BLACK	12	2 strands	S-610
	1	4	18	45	BLACK	24	6 strands	S-197
	1	4	18	45	BLACK	36	6 strands	S-187
	1	4	30	75	BLACK	24	12 strands	S-317
	1	4	60	150	BLACK	36	2 strands	S-607

NON NEEDED - STANDARD LENGTH								
Description	USP Size	EP Size	Length (in)	Length (cm)	Color	Units per box	Comments	Reorder code
STANDARD LENGTH	2	5	40	100	BLACK	36	Standard Length	S-206
	3&4	6	72	180	BLACK	12	Standard Length	S-199

NON NEEDED - REEL								
Description	USP Size	EP Size	Length (in)	Length (cm)	Color	Units per box	Comments	Reorder code
REEL	4-0	1.5	98	250	BLACK	24		LS-640
	3-0	2	98	250	BLACK	24		LS-639
	2-0	3	98	250	BLACK	24		LS-638
	0	3.5	98	250	BLACK	24		LS-637
	1	4	98	250	BLACK	24		LS-636

Surgipro™ II and Surgipro™ 7-0, 8-0; Sofsilik™ 8-0; Polysorb™, Biosyn™, Monosof™, Maxon™, Velosorb™ Fast sutures differ from USP and EP only in diameter. Please refer to IFU for more details.

© 2018 Medtronic. All rights reserved. Medtronic, Medtronic logo and Further, Together are trademarks of Medtronic.







™*Third party brands are trademarks of their respective owners.

All other brands are trademarks of a Medtronic company.

11/2018 US170542

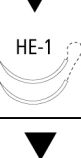
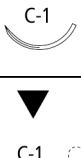
SOFSILK™

Coated, Braided Silk Non-Absorbable Sutures

REVERSE CUTTING									
Description		USP Size	EP Size	Length (in)	Length (cm)	Color	Units per box	Comments	Reorder code
HE-6 - HE-6 3/8 CIRCLE 7.4mm (Double armed)		7-0	0.5	18	45	BLACK	12		S-1768K
		6-0	0.7	18	45	BLACK	12	Surgalloy™	S-1769K
HE-5 - HE-5 3/8 CIRCLE 8.6mm (Double armed)		6-0	0.7	12	30	BLACK	12	Surgalloy™	S-1746K
HE-1 - HE-1 3/8 CIRCLE 11mm (Double armed)		6-0	0.7	18	45	BLACK	12	Surgalloy™	S-1750K
C-1 3/8 CIRCLE 12mm		6-0	0.7	18	45	BLACK	36		S-1172
		5-0	1	18	45	BLACK	36		S-1173
		4-0	1.5	18	45	BLACK	36	Reliapro™needle	S-1174
		4-0	1.5	30	75	BLACK	36	Reliapro™needle	S-1373
C-1 - C-1 3/8 CIRCLE 12mm (Double armed)		6-0	0.7	18	45	BLACK	12		S-1272
		4-0	1.5	12	30	BLACK	12	Reliapro™needle	S-1735
		4-0	1.5	18	45	BLACK	12	Reliapro™needle	S-1274
HE-3 3/8 CIRCLE 13mm		4-0	1.5	18	45	BLACK	12	Surgalloy™	S-1789K
HE-3 - HE-3 3/8 CIRCLE 13mm (Double armed)		4-0	1.5	18	45	BLACK	12	Surgalloy™	S-1783K
C-12 3/8 CIRCLE 16mm		6-0	0.7	18	45	BLACK	36	Reliapro™needle	SS-681
		5-0	1	30	75	BLACK	36	Reliapro™needle	SS-673
		4-0	1.5	18	45	BLACK	12	Reliapro™needle	SS-686
		4-0	1.5	30	75	BLACK	36	Reliapro™needle	SS-645
		3-0	2	30	75	BLACK	36	Reliapro™needle	SS-745
		2-0	3	30	75	BLACK	36	Reliapro™needle	SS-746

Surgipro™ II and Surgipro™ 7-0, 8-0; Sofsilik™ 8-0; Polysorb™, Biosyn™, Monosof™, Maxon™, Velosorb™ Fast sutures differ from USP and EP only in diameter. Please refer to IFU for more details.

© 2018 Medtronic. All rights reserved. Medtronic, Medtronic logo and Further, Together are trademarks of Medtronic.



™*Third party brands are trademarks of their respective owners.

All other brands are trademarks of a Medtronic company.

11/2018 US170542

SOFSILK™

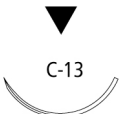
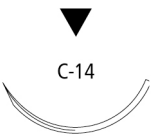
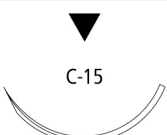
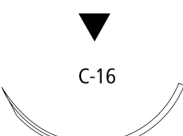
Coated, Braided Silk Non-Absorbable Sutures

REVERSE CUTTING								
Description	USP Size	EP Size	Length (in)	Length (cm)	Color	Units per box	Comments	Reorder code
C-13 3/8 CIRCLE 19mm 	5-0	1	18	45	BLACK	36	Reliapoint™needle	SS-682
	5-0	1	30	75	BLACK	36	Reliapoint™needle	SS-652
	4-0	1.5	18	45	BLACK	36	Reliapoint™needle	SS-683
	4-0	1.5	18	45	BLACK	12	Reliapoint™needle	SS-683G
	4-0	1.5	30	75	BLACK	36	Reliapoint™needle	SS-653
	3-0	2	18	45	BLACK	36	Reliapoint™needle	SS-694
	3-0	2	30	75	BLACK	36	Reliapoint™needle	SS-654
	2-0	3	30	75	BLACK	36	Reliapoint™needle	SS-655
	0	3.5	30	75	BLACK	36	Reliapoint™needle	SS-656
C-14 3/8 CIRCLE 24mm 	4-0	1.5	18	45	BLACK	36	Reliapoint™needle	SS-629
	3-0	2	18	45	BLACK	36	Reliapoint™needle	SS-684
	3-0	2	18	45	BLACK	12	Reliapoint™needle	SS-684G
	3-0	2	30	75	BLACK	36	Reliapoint™needle	SS-784
	2-0	3	18	45	BLACK	36	Reliapoint™needle	SS-695
	2-0	3	30	75	BLACK	36	Reliapoint™needle	SS-785
	0	3.5	30	75	BLACK	36	Reliapoint™needle	SS-786
	1	4	30	75	BLACK	36	Reliapoint™needle	SS-787
C-15 3/8 CIRCLE 26mm 	2-0	3	18	45	BLACK	36	Reliapoint™needle	SS-685
	2-0	3	18	45	BLACK	12	Reliapoint™needle	SS-685G
C-16 3/8 CIRCLE 30mm 	3-0	2	30	75	BLACK	36	Reliapoint™needle	SS-675
	2-0	3	18	45	BLACK	36	Reliapoint™needle	SS-677
	2-0	3	30	75	BLACK	36	Reliapoint™needle	SS-679
	0	3.5	18	45	BLACK	36	Reliapoint™needle	SS-678
	0	3.5	30	75	BLACK	36	Reliapoint™needle	SS-680
	0	3.5	30	75	BLACK	24	5 strands, D-Tach™ Reliapoint™needle	SS-70-M
	1	4	30	75	BLACK	36	Reliapoint™needle	SS-689
C-17 3/8 CIRCLE 39mm 	2-0	3	30	75	BLACK	36	Reliapoint™needle	SS-648
	0	3.5	30	75	BLACK	36	Reliapoint™needle	SS-647
	2	5	30	75	BLACK	36	Reliapoint™needle	SS-651
	1	4	30	75	BLACK	36	Reliapoint™needle	SS-646

Surgipro™ II and Surgipro™ 7-0, 8-0; Sofsilik™ 8-0; Polysorb™, Biosyn™, Monosof™, Maxon™, Velosorb™ Fast sutures differ from USP and EP only in diameter. Please refer to IFU for more details.

© 2018 Medtronic. All rights reserved. Medtronic, Medtronic logo and Further, Together are trademarks of Medtronic.







™*Third party brands are trademarks of their respective owners.

All other brands are trademarks of a Medtronic company.

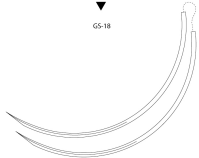
11/2018 US170542

SOFSILK™

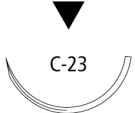
Coated, Braided Silk Non-Absorbable Sutures

REVERSE CUTTING									
Description	USP Size	EP Size	Length (in)	Length (cm)	Color	Units per box	Comments	Reorder code	
GS-18 - GS-18 3/8 CIRCLE 77mm (Double armed) (Not to scale)	2	5	30	75	BLACK	24		CS-482	
HE-7 - HE-7 1/2 CIRCLE 7.4mm (Double armed)	7-0	0.5	18	45	BLACK	12	Surgalloy™	S-1766K	
	6-0	0.7	18	45	BLACK	12	Surgalloy™	S-1765K	
C-21 1/2 CIRCLE 13mm	4-0	1.5	18	45	BLACK	24	5 strands, D-Tach™, Reliapoint™needle	SS-82-M	
C-22 1/2 CIRCLE 18mm	4-0	1.5	18	45	BLACK	36	Reliapoint™needle	SS-733	
C-23 1/2 CIRCLE 24mm	3-0	2	18	45	BLACK	36	Reliapoint™needle	SS-732	
	3-0	2	30	75	BLACK	36	Reliapoint™needle	SS-632	
	2-0	3	18	45	BLACK	36	Reliapoint™needle	SS-734	
	2-0	3	30	75	BLACK	36	Reliapoint™needle	SS-633	
GS-10 1/2 CIRCLE 26mm	2-0	3	18	45	BLACK	36		CS-390	
GS-11 1/2 CIRCLE 37mm	2-0	3	30	75	BLACK	36		CS-490	

Surgipro™ II and Surgipro™ 7-0, 8-0; Sofsilik™ 8-0; Polysorb™, Biosyn™, Monosof™, Maxon™, Velosorb™ Fast sutures differ from USP and EP only in diameter. Please refer to IFU for more details.

© 2018 Medtronic. All rights reserved. Medtronic, Medtronic logo and Further, Together are trademarks of Medtronic.







™*Third party brands are trademarks of their respective owners.

All other brands are trademarks of a Medtronic company.

11/2018 US170542

SOFSILK™

Coated, Braided Silk Non-Absorbable Sutures

PREMIUM REVERSE CUTTING									
Description	USP Size	EP Size	Length (in)	Length (cm)	Color	Units per box	Comments	Reorder code	
P-10 3/8 CIRCLE 11mm 	6-0	0.7	18	45	BLACK	36	Edgellant™ needle, Surgalloy™ alloy	SS-5639	
	6-0	0.7	18	45	BLACK	12	Edgellant™ needle, Surgalloy™ alloy	SS-1639G	
P-13 3/8 CIRCLE 13mm 	6-0	0.7	18	45	BLACK	12	Edgellant™ needle, Surgalloy™ alloy	SS-5649G	
	5-0	1	18	45	BLACK	36	Edgellant™ needle, Surgalloy™ alloy	SS-5640	
	4-0	1.5	18	45	BLACK	36	Edgellant™ needle, Surgalloy™ alloy	SS-5641	
	4-0	1.5	18	45	BLACK	12	Edgellant™ needle, Surgalloy™ alloy	SS-5641G	
P-11 3/8 CIRCLE 16mm 	5-0	1	18	45	BLACK	36	Edgellant™ needle, Surgalloy™ alloy	SS-5678	
P-12 3/8 CIRCLE 19mm 	5-0	1	18	45	BLACK	36	Edgellant™ needle, Surgalloy™ alloy	SS-5676	
	4-0	1.5	18	45	BLACK	36	Edgellant™ needle, Surgalloy™ alloy	SS-5677	
	3-0	2	18	45	BLACK	36	Edgellant™ needle, Surgalloy™ alloy	SS-5679	
P-14 3/8 CIRCLE 24mm 	3-0	2	18	45	BLACK	36	Edgellant™ needle, Surgalloy™ alloy	SS-5684	
	2-0	3	18	45	BLACK	12	Edgellant™ needle, Surgalloy™ alloy	SS-5685G	
P-24 1/2 CIRCLE 16mm 	4-0	1.5	18	45	BLACK	12	Edgellant™ needle, Surgalloy™ alloy	SS-1694G	

Surgipro™ II and Surgipro™ 7-0, 8-0; Sofsilik™ 8-0; Polysorb™, Biosyn™, Monosof™, Maxon™, Velosorb™ Fast sutures differ from USP and EP only in diameter. Please refer to IFU for more details.

© 2018 Medtronic. All rights reserved. Medtronic, Medtronic logo and Further, Together are trademarks of Medtronic.

™*Third party brands are trademarks of their respective owners.

All other brands are trademarks of a Medtronic company.

11/2018 US170542

SOFSILK™

Coated, Braided Silk Non-Absorbable Sutures

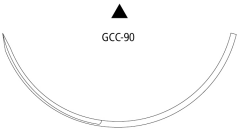
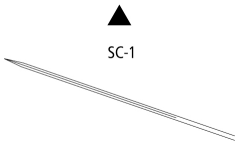
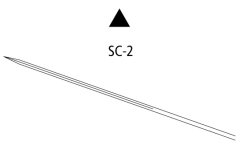
CONVENTIONAL CUTTING								
Description	USP Size	EP Size	Length (in)	Length (cm)	Color	Units per box	Comments	Reorder code
GCC-90 3/8 CIRCLE 90mm (Not to scale)		2-0	3	40	100	BLACK	36	CS-791
		0	3.5	40	100	BLACK	36	CS-792
		2	5	40	100	BLACK	36	CS-794
		1	4	40	100	BLACK	36	CS-793
SC-1 - SC-1 STRAIGHT 51mm (Double armed) (Not to scale)		2-0	3	30	75	BLACK	36	SS-523
		1	4	30	75	BLACK	36	SS-525
SC-2 STRAIGHT 60mm (Not to scale)		4-0	1.5	30	75	BLACK	36	SS-621
		3-0	2	30	75	BLACK	36	SS-622
		3-0	2	30	75	BLACK	12	SS622G
		3-0	2	40	100	BLACK	36	SS-722
		2-0	3	30	75	BLACK	36	SS-623
		2-0	3	40	100	BLACK	36	SS-723
		0	3.5	30	75	BLACK	36	SS-624

Surgipro™ II and Surgipro™ 7-0, 8-0; Sofsilik™ 8-0; Polysorb™, Biosyn™, Monosof™, Maxon™, Velosorb™ Fast sutures differ from USP and EP only in diameter. Please refer to IFU for more details.

© 2018 Medtronic. All rights reserved. Medtronic, Medtronic logo and Further, Together are trademarks of Medtronic.





™*Third party brands are trademarks of their respective owners.

All other brands are trademarks of a Medtronic company.

11/2018 US170542

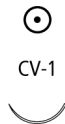
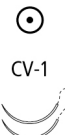
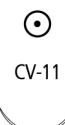
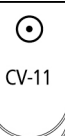
SOFSILK™

Coated, Braided Silk Non-Absorbable Sutures

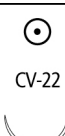
TAPER POINT									
Description		USP Size	EP Size	Length (in)	Length (cm)	Color	Units per box	Comments	Reorder code
CV-1 3/8 CIRCLE 9mm	 CV-1	6-0	0.7	18	45	BLACK	36	Surgalloy™	VS-802
		6-0	0.7	18	45	BLACK			VS82G
CV-1 - CV-1 3/8 CIRCLE 9mm (Double armed)	 CV-1	7-0	0.5	18	45	BLACK	36	Surgalloy™	VS-809
		7-0	0.5	18	45	BLACK	12	12 strands, Surgalloy™	VS89G
CV-11 3/8 CIRCLE 13mm	 CV-11	6-0	0.7	30	75	BLACK	36	Surgalloy™	VS-889
		5-0	1	30	75	BLACK	36	Surgalloy™	VS-890
		4-0	1.5	30	75	BLACK	36	Surgalloy™	VS-891
CV-11 - CV-11 3/8 CIRCLE 13mm (Double armed)	 CV-11	6-0	0.7	18	45	BLACK	36	Surgalloy™	VS-806
		6-0	0.7	24	60	BLACK	12	5 strands, Surgalloy™	VS-706-M
		4-0	1.5	18	45	BLACK	36	Surgalloy™	VS-709
CV-15 3/8 CIRCLE 17mm	 CV-15	5-0	1	30	75	BLACK	36	Surgalloy™	VS-880
		4-0	1.5	30	75	BLACK	36	Surgalloy™	VS-881
		3-0	2	30	75	BLACK	36	Surgalloy™	VS-882
		2-0	3	30	75	BLACK	36	Surgalloy™	VS-823
CV-15 - CV-15 3/8 CIRCLE 17mm (Double armed)	 CV-15	4-0	1.5	24	60	BLACK	36	Surgalloy™	VS-581
CVF-21 1/2 CIRCLE 12mm	 CVF-21	5-0	1	18	45	BLACK	36	Surgalloy™	CS-210
		4-0	1.5	18	45	BLACK	36	Surgalloy™	CS-211
CV-22 1/2 CIRCLE 13mm	 CV-22	5-0	1	18	45	BLACK	24	5 strands, D-Tach™	GS-43-M
		4-0	1.5	18	45	BLACK	24	5 strands, D-Tach™	GS-44-M

Surgipro™ II and Surgipro™ 7-0, 8-0; Sofsilik™ 8-0; Polysorb™, Biosyn™, Monosof™, Maxon™, Velosorb™ Fast sutures differ from USP and EP only in diameter. Please refer to IFU for more details.

© 2018 Medtronic. All rights reserved. Medtronic, Medtronic logo and Further, Together are trademarks of Medtronic.





™*Third party brands are trademarks of their respective owners.

All other brands are trademarks of a Medtronic company.

11/2018 US170542

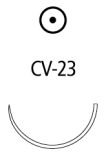
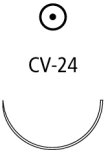
SOFSILK™

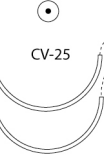
Coated, Braided Silk Non-Absorbable Sutures

TAPER POINT									
Description		USP Size	EP Size	Length (in)	Length (cm)	Color	Units per box	Comments	Reorder code
CV-23 1/2 CIRCLE 17mm		5-0	1	30	75	BLACK	36	Surgalloy™	VS-870
		4-0	1.5	18	45	BLACK	24	5 strands, D-Tach™	GS-46-M
		4-0	1.5	18	45	BLACK	24	5 strands, D-Tach™	GSJ-46-M
		4-0	1.5	30	75	BLACK	36	Surgalloy™	VS-871
		3-0	2	18	45	BLACK	24	5 strands, D-Tach™	GS-47-M
		3-0	2	18	45	BLACK	24	5 strands, D-Tach™	GSJ-47-M
		3-0	2	30	75	BLACK	36	Surgalloy™	VS-872
		2-0	3	30	75	BLACK	36	Surgalloy™	VS-873
CV-24 1/2 CIRCLE 20mm		4-0	1.5	18	45	BLACK	24	5 strands, D-Tach™	GSJ-36-M
		4-0	1.5	30	75	BLACK	36		GS-451
		3-0	2	18	45	BLACK	24	5 strands, D-Tach™	GSJ-37-M
		3-0	2	30	75	BLACK	36		GS-452
		2-0	3	30	75	BLACK	36		GS-453
CV-25 1/2 CIRCLE 22mm		4-0	1.5	18	45	BLACK	24	5 strands, D-Tach™	GS-34-M
		4-0	1.5	18	45	BLACK	24	5 strands, D-Tach™	GSJ-34-M
		3-0	2	18	45	BLACK	24	5 strands, D-Tach™	GS-33-M
		3-0	2	18	45	BLACK	24	5 strands, D-Tach™	GSJ-33-M
		3-0	2	30	75	BLACK	24	5 strands, D-Tach™	GS-30-M
CV-25 - CV-25 1/2 CIRCLE 22mm (Double armed)		3-0	2	30	75	BLACK	36	Surgalloy™	VS-552
GS-23 1/2 CIRCLE 22mm		2-0	3	30	75	BLACK	36		CS-562

Surgipro™ II and Surgipro™ 7-0, 8-0; Sofsilik™ 8-0; Polysorb™, Biosyn™, Monosof™, Maxon™, Velosorb™ Fast sutures differ from USP and EP only in diameter. Please refer to IFU for more details.

© 2018 Medtronic. All rights reserved. Medtronic, Medtronic logo and Further, Together are trademarks of Medtronic.



™*Third party brands are trademarks of their respective owners.

All other brands are trademarks of a Medtronic company.

11/2018 US170542

SOFSILK™

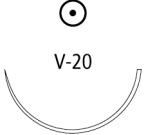
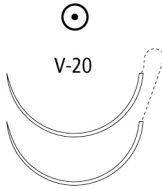
Coated, Braided Silk Non-Absorbable Sutures

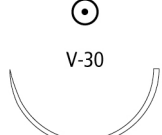
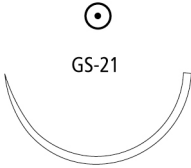
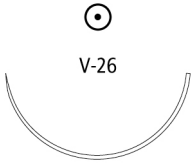
TAPER POINT								
Description	USP Size	EP Size	Length (in)	Length (cm)	Color	Units per box	Comments	Reorder code
V-20 1/2 CIRCLE 26mm 	4-0	1.5	18	45	BLACK	24	5 strands, D-Tach™	GS-64-M
	4-0	1.5	18	45	BLACK	24	5 strands, D-Tach™	GSJ-64-M
	4-0	1.5	30	75	BLACK	36		GS-831
	3-0	2	18	45	BLACK	24	5 strands, D-Tach™	GS-63-M
	3-0	2	18	45	BLACK	24	5 strands, D-Tach™	GSJ-63-M
	3-0	2	30	75	BLACK	36		GS-832
	3-0	2	30	75	BLACK	24	5 strands, D-Tach™	GS-67-M
	2-0	3	18	45	BLACK	24	5 strands, D-Tach™	GS-62-M
	2-0	3	30	75	BLACK	24	5 strands, D-Tach™	GS-66-M
	2-0	3	30	75	BLACK	36		GS-833
	0	3.5	30	75	BLACK	24	5 strands, D-Tach™	GS-65-M
	0	3.5	30	75	BLACK	36		GS-834
V-20 - V-20 1/2 CIRCLE 26mm (Double armed) 	2-0	3	36	90	BLACK	36	Surgalloy™	VS-533
GS-22 1/2 CIRCLE 27mm 	2-0	3	18	45	BLACK	24	5 strands, D-Tach™	CS-16-M
	0	3.5	18	45	BLACK	24	5 strands, D-Tach™	CS-17-M
V-30 1/2 CIRCLE 30mm 	3-0	2	30	75	BLACK	36		GS-822
	2-0	3	30	75	BLACK	36		GS-823
	0	3.5	30	75	BLACK	36		GS-824
GS-21 1/2 CIRCLE 37mm 	2-0	3	18	45	BLACK	24	5 strands, D-Tach™	CS-9-M
	2-0	3	30	75	BLACK	36		CS-423
	0	3.5	18	45	BLACK	24	5 strands, D-Tach™	CS-10-M
	0	3.5	30	75	BLACK	36		CS-424
	1	4	30	75	BLACK	36		CS-425
V-26 1/2 CIRCLE 37mm 	3-0	2	30	75	BLACK	36		VS-842
	2-0	3	30	75	BLACK	36		VS-843
	0	3.5	30	75	BLACK	36		VS-844
	2	5	30	75	BLACK	36		VS-846
	2	5	30	75	WHITE	24	2 strands, D-Tach™	CS-746
	1	4	30	75	WHITE	36		CS-744
	1	4	30	75	WHITE	24	2 strands, D-Tach™	CS-745
	1	4	30	75	BLACK	36		VS-845

Surgipro™ II and Surgipro™ 7-0, 8-0; Sofsilik™ 8-0; Polysorb™, Biosyn™, Monosof™, Maxon™, Velosorb™ Fast sutures differ from USP and EP only in diameter. Please refer to IFU for more details.

© 2018 Medtronic. All rights reserved. Medtronic, Medtronic logo and Further, Together are trademarks of Medtronic.



™*Third party brands are trademarks of their respective owners.

All other brands are trademarks of a Medtronic company.

11/2018 US170542

SOFSILK™

Coated, Braided Silk Non-Absorbable Sutures

HEAVY TAPER POINT									
Description	USP Size	EP Size	Length (in)	Length (cm)	Color	Units per box	Comments	Reorder code	
HGS-23 1/2 CIRCLE 22mm  HGS-23	0	3.5	18	45	BLACK	24	5 strands, D-Tach™	CS-92-M	
HGS-22 1/2 CIRCLE 27mm  HGS-22	0	3.5	18	45	BLACK	24	5 strands, D-Tach™	CS-85-M	

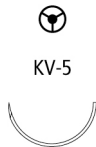
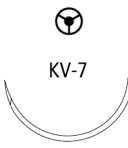
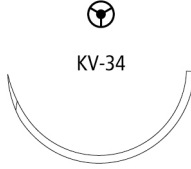
TAPERCUTTING									
Description	USP Size	EP Size	Length (in)	Length (cm)	Color	Units per box	Comments	Reorder code	
KV-5 1/2 CIRCLE 17mm  KV-5	3-0	2	30	75	BLACK	36	Surgalloy™	VS-863	
KV-7 1/2 CIRCLE 26mm  KV-7	2-0	3	30	75	BLACK	36	Surgalloy™	VS-964	
KV-34 1/2 CIRCLE 37mm  KV-34	1	4	30	75	WHITE	12	2 strands, D-Tach™	VS-766G	

Surgipro™ II and Surgipro™ 7-0, 8-0; Sofsilik™ 8-0; Polysorb™, Biosyn™, Monosof™, Maxon™, Velosorb™ Fast sutures differ from USP and EP only in diameter. Please refer to IFU for more details.

© 2018 Medtronic. All rights reserved. Medtronic, Medtronic logo and Further, Together are trademarks of Medtronic.









™*Third party brands are trademarks of their respective owners.

All other brands are trademarks of a Medtronic company.

11/2018 US170542

SOFSILK™

Coated, Braided Silk Non-Absorbable Sutures

PREMIUM SPATULA									
Description		USP Size	EP Size	Length (in)	Length (cm)	Color	Units per box	Comments	Reorder code
SE-100-8 - SE-100-8 1/4 CIRCLE 6.3mm (Double armed)	 SE-100-8 	8-0	0.4	18	45	BLACK	12	Surgalloy™	S-2176K
SS-14 - SS-14 1/4 CIRCLE 8.6mm (Double armed)	 SS-14 	6-0	0.7	18	45	BLACK	12	Surgalloy™	S-1780K
SS-24 - SS-24 1/4 CIRCLE 8.6mm (Double armed)	 SS-24 	6-0	0.7	18	45	BLACK	12	Surgalloy™	S-2780K
		4-0	1.5	18	45	WHITE	12		S-2782K
SE-140-8 - SE-140-8 3/8 CIRCLE 6.3mm (Double armed)	 SE-140-8 	8-0	0.4	12	30	BLACK	12	Surgalloy™	S-2752K
		8-0	0.4	18	45	BLACK	12	Surgalloy™	S-1734K
		7-0	0.5	18	45	BLACK	12	Surgalloy™	S-1733K
		6-0	0.7	18	45	BLACK	12	Surgalloy™	S-1732K

Surgipro™ II and Surgipro™ 7-0, 8-0; Sofsilik™ 8-0; Polysorb™, Biosyn™, Monosof™, Maxon™, Velosorb™ Fast sutures differ from USP and EP only in diameter. Please refer to IFU for more details.

© 2018 Medtronic. All rights reserved. Medtronic, Medtronic logo and Further, Together are trademarks of Medtronic.

™*Third party brands are trademarks of their respective owners.

All other brands are trademarks of a Medtronic company.

11/2018 US170542

SOFSILK™

Coated, Braided Silk Non-Absorbable Sutures

Reorder Code	Page	Reorder Code	Page	Reorder Code	Page
CS-10-M	223	GS-823	223	S-1789K	216
CS-16-M	223	GS-824	223	S-182	215
CS-17-M	223	GS-831	223	S-183	215
CS-210	221	GS-832	223	S-184	215
CS-211	221	GS-833	223	S-185	215
CS-390	218	GS-834	223	S-187	215
CS-423	223	GS-835	223	S-193	215
CS-424	223	GSJ-33-M	222	S-194	215
CS-425	223	GSJ-34-M	222	S-195	215
CS-482	218	GSJ-36-M	222	S-196	215
CS-490	218	GSJ-37-M	222	S-197	215
CS-562	222	GSJ-46-M	222	S-199	215
CS-744	223	GSJ-47-M	222	S-206	215
CS-745	223	GSJ-63-M	223	S-2176K	225
CS-746	223	GSJ-64-M	223	S-243	215
CS-791	220	LS-636	215	S-244	215
CS-792	220	LS-637	215	S-245	215
CS-793	220	LS-638	215	S-246	215
CS-794	220	LS-639	215	S-254	215
CS-85-M	224	LS-640	215	S-255	215
CS-92-M	224	S-1172	216	S-2752K	225
CS-9-M	223	S-1173	216	S-2780K	225
GS-30-M	222	S-1174	216	S-2782K	225
GS-33-M	222	S-1272	216	S-282	215
GS-34-M	222	S-1274	216	S-303	215
GS-43-M	221	S-1373	216	S-304	215
GS-44-M	221	S-1732K	225	S-305	215
GS-451	222	S-1733K	225	S-316	215
GS-452	222	S-1734K	225	S-317	215
GS-453	222	S-1735	216	S-318	215
GS-46-M	222	S-1746K	216	S-346	215
GS-47-M	222	S-1750K	216	S-403	215
GS-62-M	223	S-176	215	S-404	215
GS-63-M	223	S-1765K	218	S-405	215
GS-64-M	223	S-1766K	218	S-605	215
GS-65-M	223	S-1768K	216	S-606	215
GS-66-M	223	S-1769K	216	S-607	215
GS-67-M	223	S-1780K	225	S-608	215
GS-822	223	S-1783K	216	S-610	215

Surgipro™ II and Surgipro™ 7-0, 8-0; SofsilK™ 8-0; Polysorb™, Biosyn™, Monosof™, Maxon™, Velosorb™ Fast sutures differ from USP and EP only in diameter. Please refer to IFU for more details.

© 2018 Medtronic. All rights reserved. Medtronic, Medtronic logo and Further, Together are trademarks of Medtronic.

™*Third party brands are trademarks of their respective owners.

All other brands are trademarks of a Medtronic company.

11/2018 US170542

SOFSILK™

Coated, Braided Silk Non-Absorbable Sutures

Reorder Code	Page	Reorder Code	Page	Reorder Code	Page
SS-1639G	219	SS-681	216	VS-845	223
SS-1694G	219	SS-682	217	VS-846	223
SS-523	220	SS-683	217	VS-863	224
SS-525	220	SS-683G	217	VS-870	222
SS-5639	219	SS-684	217	VS-871	222
SS-5640	219	SS-684G	217	VS-872	222
SS-5641	219	SS-685	217	VS-873	222
SS-5641G	219	SS-685G	217	VS-880	221
SS-5649G	219	SS-686	216	VS-881	221
SS-5676	219	SS-689	217	VS-882	221
SS-5677	219	SS-694	217	VS-889	221
SS-5678	219	SS-695	217	VS-890	221
SS-5679	219	SS-70-M	217	VS-891	221
SS-5684	219	SS-722	220	VS89G	221
SS-5685G	219	SS-723	220	VS-964	224
SS-621	220	SS-732	218		
SS-622	220	SS-733	218		
SS622G	220	SS-734	218		
SS-623	220	SS-745	216		
SS-624	220	SS-746	216		
SS-629	217	SS-784	217		
SS-632	218	SS-785	217		
SS-633	218	SS-786	217		
SS-645	216	SS-787	217		
SS-646	217	SS-82-M	218		
SS-647	217	VS-533	223		
SS-648	217	VS-552	222		
SS-651	217	VS-581	221		
SS-652	217	VS-706-M	221		
SS-653	217	VS-709	221		
SS-654	217	VS-766G	224		
SS-655	217	VS-802	221		
SS-656	217	VS-806	221		
SS-673	216	VS-809	221		
SS-675	217	VS-823	221		
SS-677	217	VS82G	221		
SS-678	217	VS-842	223		
SS-679	217	VS-843	223		
SS-680	217	VS-844	223		

Surgipro™ II and Surgipro™ 7-0, 8-0; Sofsilik™ 8-0; Polysorb™, Biosyn™, Monosoft™, Maxon™, Velosorb™ Fast sutures differ from USP and EP only in diameter. Please refer to IFU for more details.

© 2018 Medtronic. All rights reserved. Medtronic, Medtronic logo and Further, Together are trademarks of Medtronic.

™*Third party brands are trademarks of their respective owners.

All other brands are trademarks of a Medtronic company.

11/2018 US170542



V-LOC™ 90

Absorbable Wound Closure Device

Description	The V-Loc™ 90 absorbable wound closure device consists of a barbed absorbable thread, armed with a surgical needle at one end and a loop end effector at the other. The barb and loop end effector design allow for tissue approximation without the need to tie surgical knots. The V-Loc™ 90 absorbable wound closure device is prepared from a synthetic polyester composed of glycolide, dioxanone, and trimethylene carbonate. The absorbable wound closure device is available undyed or violet. The device is sterile, inert, noncollagenous and nonantigenic.
Indications	V-Loc™ 90 absorbable wound closure devices are indicated for soft tissue approximation where use of an absorbable suture is appropriate.
Actions	V-Loc™ 90 absorbable wound closure devices elicit a minimal acute inflammatory reaction in tissues, which is followed by a gradual encapsulation of the device by fibrous connective tissue. Progressive loss of tensile strength and eventual absorption of V-Loc™ 90 absorbable wound closure device occurs by means of hydrolysis where the device is broken down to glycolic acid, dioxanoic acid, propane diol and carbon dioxide which are subsequently absorbed and metabolized by the body.
Tensile Strength	Approximately 90% of initial tensile strength at 1 week, 75% at 2 weeks postimplant.
Sterilization	Ethylene oxide.
Absorption	Absorption begins as a loss of tensile strength without appreciable loss of mass. Animal data indicates that the absorption is essentially complete between 90 and 110 days.
Packaging	The V-Loc™ 90 absorbable wound closure devices are available in USP and EP sizes 2-0 (3 metric) through 4-0 (1.5 Metric). The V-Loc™ 90 absorbable wound closure devices are available dyed violet or undyed (natural). The devices are supplied sterile, in pre-cut lengths affixed to various needle types. The devices are available in box quantities of one dozen. Please refer to the individual package IFUs for complete instructions, indications, contraindications, warnings and precautions.

V-LOC™ 90

Absorbable Wound Closure Device

PREMIUM REVERSE CUTTING									
Description	USP Size	EP Size	Length (in)	Length (cm)	Color	Units per box	Comments	Reorder code	
P-11 3/8 CIRCLE 16mm 	4-0	1.5	12		UNDYED	12	Edgellant™ needle, Surgalloy™ alloy	VLOCM1413	
	4-0	1.5	18		UNDYED	12	Edgellant™ needle, Surgalloy™ alloy	VLOCM1423	
P-12 3/8 CIRCLE 19mm 	4-0	1.5	12		UNDYED	12	Edgellant™ needle, Surgalloy™ alloy	VLOCM0013	
	4-0	1.5	23		UNDYED	12	Edgellant™ needle, Surgalloy™ alloy	VLOCM0033	
	4-0	1.5	6		UNDYED	12	Edgellant™ needle, Surgalloy™ alloy	VLOCM0003	
	4-0	1.5	18		UNDYED	12	Edgellant™ needle, Surgalloy™ alloy	VLOCM0023	
	3-0	2	6		UNDYED	12	Edgellant™ needle, Surgalloy™ alloy	VLOCM0004	
	3-0	2	12		UNDYED	12	Edgellant™ needle, Surgalloy™ alloy	VLOCM0014	
	3-0	2	18		UNDYED	12	Edgellant™ needle, Surgalloy™ alloy	VLOCM0024	
	3-0	2	23		UNDYED	12	Edgellant™ needle, Surgalloy™ alloy	VLOCM0034	
	2-0	3	12		UNDYED	12	Edgellant™ needle, Surgalloy™ alloy	VLOCM0015	
	2-0	3	18		UNDYED	12	Edgellant™ needle, Surgalloy™ alloy	VLOCM0025	
	2-0	3	6		UNDYED	12	Edgellant™ needle, Surgalloy™ alloy	VLOCM0005	
	2-0	3	23		UNDYED	12	Edgellant™ needle, Surgalloy™ alloy	VLOCM0035	
	P-14 3/8 CIRCLE 24mm 	4-0	1.5	23		UNDYED	12	Edgellant™ needle, Surgalloy™ alloy	VLOCM0133
4-0		1.5	12		UNDYED	12	Edgellant™ needle, Surgalloy™ alloy	VLOCM0113	
4-0		1.5	18		UNDYED	12	Edgellant™ needle, Surgalloy™ alloy	VLOCM0123	
3-0		2	18		UNDYED	12	Edgellant™ needle, Surgalloy™ alloy	VLOCM0124	
3-0		2	12		UNDYED	12	Edgellant™ needle, Surgalloy™ alloy	VLOCM0114	
3-0		2	23		UNDYED	12	Edgellant™ needle, Surgalloy™ alloy	VLOCM0134	
2-0		3	18		UNDYED	12	Edgellant™ needle, Surgalloy™ alloy	VLOCM0125	
2-0		3	23		UNDYED	12	Edgellant™ needle, Surgalloy™ alloy	VLOCM0135	
2-0		3	12		UNDYED	12	Edgellant™ needle, Surgalloy™ alloy	VLOCM0115	
2-0		3	9		VIOLET	12	Edgellant™ needle, Surgalloy™ alloy	VLOCM3245	

Surgipro™ II and Surgipro™ 7-0, 8-0; Sofsilik™ 8-0; Polysorb™, Biosyn™, Monosof™, Maxon™, Velosorb™ Fast sutures differ from USP and EP only in diameter. Please refer to IFU for more details.

© 2018 Medtronic. All rights reserved. Medtronic, Medtronic logo and Further, Together are trademarks of Medtronic.

™*Third party brands are trademarks of their respective owners.

All other brands are trademarks of a Medtronic company.

11/2018 US170542

V-LOC™ 90

Absorbable Wound Closure Device

PREMIUM REVERSE CUTTING									
Description	USP Size	EP Size	Length (in)	Length (cm)	Color	Units per box	Comments	Reorder code	
P-17 3/8 CIRCLE 30mm 	3-0	2	18		UNDYED	12	Edgellant™ needle, Surgalloy™ alloy	VLOCM1824	

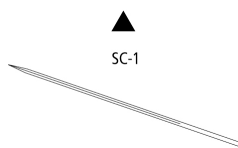
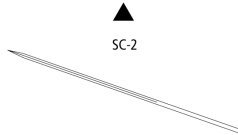
CONVENTIONAL CUTTING									
Description	USP Size	EP Size	Length (in)	Length (cm)	Color	Units per box	Comments	Reorder code	
SC-1 STRAIGHT 51mm (Not to scale) 	3-0	2	18	45	UNDYED	12		VLOCM1624	
SC-2 STRAIGHT 60mm (Not to scale) 	4-0	1.5	18	45	UNDYED	12		VLOCM0223	
	3-0	2	18	45	UNDYED	12		VLOCM0224	

Surgipro™ II and Surgipro™ 7-0, 8-0; Sofsilik™ 8-0; Polysorb™, Biosyn™, Monosof™, Maxon™, Velosorb™ Fast sutures differ from USP and EP only in diameter. Please refer to IFU for more details.

© 2018 Medtronic. All rights reserved. Medtronic, Medtronic logo and Further, Together are trademarks of Medtronic.







™*Third party brands are trademarks of their respective owners.

All other brands are trademarks of a Medtronic company.

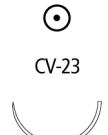
11/2018 US170542

V-LOC™ 90

Absorbable Wound Closure Device

TAPER POINT									
Description		USP Size	EP Size	Length (in)	Length (cm)	Color	Units per box	Comments	Reorder code
CV-15 3/8 CIRCLE 17mm		4-0	1.5	6	15	VIOLET	12		VLOCM1203
		3-0	2	6	15	VIOLET	12	Surgalloy™	VLOCM1204
CV-23 1/2 CIRCLE 17mm		4-0	1.5	9	23	VIOLET	12		VLOCM0843
		4-0	1.5	12	30	VIOLET	12	surgalloy™	VLOCM0813
		3-0	2	6	15	VIOLET	12	Surgalloy™	VLOCM0804
		3-0	2	6	15	UNDYED	12	Surgalloy™	VLOCM1904
		3-0	2	9	23	VIOLET	12	Surgalloy™	VLOCM0844
		3-0	2	9	23	UNDYED	12	Surgalloy™	VLOCM1944
		3-0	2	12	30	VIOLET	12		VLOCM0814
		3-0	2	18	45	VIOLET	12		VLOCM0824
V-20 1/2 CIRCLE 26mm		4-0	1.5	6	15	VIOLET	12	Surgalloy™	VLOCM0603
		4-0	1.5	18	45	VIOLET	12	Surgalloy™	VLOCM0623
		3-0	2	6	15	UNDYED	12	Surgalloy™	VLOCM2004
		3-0	2	6	15	VIOLET	12		VLOCM0604
		3-0	2	9	23	UNDYED	12	Surgalloy™	VLOCM2044
		3-0	2	9	23	VIOLET	12	Surgalloy™	VLOCM0644
		3-0	2	12	30	VIOLET	12	surgalloy™	VLOCM0614
		3-0	2	18	45	VIOLET	12		VLOCM0624
		2-0	3	18	45	VIOLET	12		VLOCM0625
		GS-22 1/2 CIRCLE 27mm		2-0	3	6	15	VIOLET	12
2-0	3			6	15	UNDYED	12		VLOCM2205
2-0	3			9	23	UNDYED	12		VLOCM2245
2-0	3			9	23	VIOLET	12		VLOCM2145
2-0	3			12	30	VIOLET	12		VLOCM2115
V-30 1/2 CIRCLE 30mm		3-0	2	9	23	VIOLET	12	Surgalloy™	VLOCM1544
		2-0	3	9	23	VIOLET	12		VLOCM1545
GS-21 1/2 CIRCLE 37mm		3-0	2	9	23	VIOLET	12		VLOCM0344
		3-0	2	18	45	VIOLET	12		VLOCM0324
		2-0	3	6	15	VIOLET	12	Surgalloy™	VLOCM0305
		2-0	3	9	23	VIOLET	12		VLOCM0345
		2-0	3	12	30	VIOLET	12		VLOCM0315
		2-0	3	18	45	UNDYED	12		VLOCM3225
GU-46 5/8 CIRCLE 27mm		3-0	2	6	15	VIOLET	12	Surgalloy™	VLOCM1704
		3-0	2	9	23	VIOLET	12		VLOCM1744

Surgipro™ II and Surgipro™ 7-0, 8-0; Sofsilik™ 8-0; Polysorb™, Biosyn™, Monosof™, Maxon™, Velosorb™ Fast sutures differ from USP and EP only in diameter. Please refer to IFU for more details.

© 2018 Medtronic. All rights reserved. Medtronic, Medtronic logo and Further, Together are trademarks of Medtronic.

™*Third party brands are trademarks of their respective owners.

All other brands are trademarks of a Medtronic company.

11/2018 US170542

V-LOC™ 90

Absorbable Wound Closure Device

Reorder Code	Page	Reorder Code	Page	Reorder Code	Page
<u>VLOCM0003</u>	<u>231</u>	<u>VLOCM0843</u>	<u>233</u>		
<u>VLOCM0004</u>	<u>231</u>	<u>VLOCM0844</u>	<u>233</u>		
<u>VLOCM0005</u>	<u>231</u>	<u>VLOCM1203</u>	<u>233</u>		
<u>VLOCM0013</u>	<u>231</u>	<u>VLOCM1204</u>	<u>233</u>		
<u>VLOCM0014</u>	<u>231</u>	<u>VLOCM1413</u>	<u>231</u>		
<u>VLOCM0015</u>	<u>231</u>	<u>VLOCM1423</u>	<u>231</u>		
<u>VLOCM0023</u>	<u>231</u>	<u>VLOCM1544</u>	<u>233</u>		
<u>VLOCM0024</u>	<u>231</u>	<u>VLOCM1545</u>	<u>233</u>		
<u>VLOCM0025</u>	<u>231</u>	<u>VLOCM1624</u>	<u>232</u>		
<u>VLOCM0033</u>	<u>231</u>	<u>VLOCM1704</u>	<u>233</u>		
<u>VLOCM0034</u>	<u>231</u>	<u>VLOCM1744</u>	<u>233</u>		
<u>VLOCM0035</u>	<u>231</u>	<u>VLOCM1824</u>	<u>232</u>		
<u>VLOCM0113</u>	<u>231</u>	<u>VLOCM1904</u>	<u>233</u>		
<u>VLOCM0114</u>	<u>231</u>	<u>VLOCM1944</u>	<u>233</u>		
<u>VLOCM0115</u>	<u>231</u>	<u>VLOCM2004</u>	<u>233</u>		
<u>VLOCM0123</u>	<u>231</u>	<u>VLOCM2044</u>	<u>233</u>		
<u>VLOCM0124</u>	<u>231</u>	<u>VLOCM2105</u>	<u>233</u>		
<u>VLOCM0125</u>	<u>231</u>	<u>VLOCM2115</u>	<u>233</u>		
<u>VLOCM0133</u>	<u>231</u>	<u>VLOCM2145</u>	<u>233</u>		
<u>VLOCM0134</u>	<u>231</u>	<u>VLOCM2205</u>	<u>233</u>		
<u>VLOCM0135</u>	<u>231</u>	<u>VLOCM2245</u>	<u>233</u>		
<u>VLOCM0223</u>	<u>232</u>	<u>VLOCM3225</u>	<u>233</u>		
<u>VLOCM0224</u>	<u>232</u>	<u>VLOCM3245</u>	<u>231</u>		
<u>VLOCM0305</u>	<u>233</u>				
<u>VLOCM0315</u>	<u>233</u>				
<u>VLOCM0324</u>	<u>233</u>				
<u>VLOCM0344</u>	<u>233</u>				
<u>VLOCM0345</u>	<u>233</u>				
<u>VLOCM0603</u>	<u>233</u>				
<u>VLOCM0604</u>	<u>233</u>				
<u>VLOCM0614</u>	<u>233</u>				
<u>VLOCM0623</u>	<u>233</u>				
<u>VLOCM0624</u>	<u>233</u>				
<u>VLOCM0625</u>	<u>233</u>				
<u>VLOCM0644</u>	<u>233</u>				
<u>VLOCM0804</u>	<u>233</u>				
<u>VLOCM0813</u>	<u>233</u>				
<u>VLOCM0814</u>	<u>233</u>				
<u>VLOCM0824</u>	<u>233</u>				

Surgipro™ II and Surgipro™ 7-0, 8-0; Sofsilik™ 8-0; Polysorb™, Biosyn™, Monosof™, Maxon™, Velosorb™ Fast sutures differ from USP and EP only in diameter. Please refer to IFU for more details.

© 2018 Medtronic. All rights reserved. Medtronic, Medtronic logo and Further, Together are trademarks of Medtronic.

™*Third party brands are trademarks of their respective owners.

All other brands are trademarks of a Medtronic company.

11/2018 US170542

V-LOC™ 180

Absorbable Wound Closure Device

Description	The V-Loc™ 180 absorbable wound closure device consists of a barbed absorbable thread, armed with a surgical needle at one end and a loop end effector at the other. The barb and loop end effector design allow for tissue approximation without the need to tie surgical knots. The V-Loc™ 180 absorbable wound closure device is prepared from a copolymer of glycolic acid and trimethylene carbonate. The absorbable wound closure device is available clear or green. The device is sterile, inert, noncollagenous and nonantigenic.
Indications	V-Loc™ 180 absorbable wound closure devices are indicated for soft tissue approximation where use of an absorbable suture is appropriate.
Actions	When implanted in animal tissue, V-Loc™ 180 absorbable wound closure devices elicit a minimal tissue reaction characteristic of foreign body response to substance. The tissue reaction resolves as the device is absorbed. Experimental animal studies for this absorbable material produced no evidence of antigenicity, systemic toxicity, carcinogenicity, mutagenicity, teratogenicity or adverse effects on reproductive performance.
Tensile Strength	Approximately 80% of initial tensile strength at 1 week, 75% at 2 weeks, and 65% at 3 weeks post implant.
Sterilization	Ethylene oxide.
Absorption	Animal data indicates that the absorption is minimal until about the 60th day after implantation. Absorption is substantially complete within six months.
Packaging	The V-Loc™ 180 absorbable wound closure devices are available in USP and EP sizes 0 (3.5 Metric) through 4-0 (1.5 Metric). The V-Loc™ 180 absorbable wound closure devices are dyed with D&C No. 6 or available Clear (Undyed). The devices are supplied sterile, in pre-cut lengths affixed to various needle types. The devices are available in box quantities of one dozen.

V-LOC™ 180

Absorbable Wound Closure Device

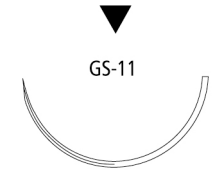
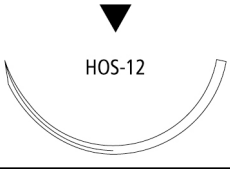
REVERSE CUTTING								
Description	USP Size	EP Size	Length (in)	Length (cm)	Color	Units per box	Comments	Reorder code
GS-11 1/2 CIRCLE 37mm 	2-0	3	12	30	CLEAR	12		VLOCL2815
	2-0	3	18	45	GREEN	12		VLOCL2825
	0	3.5	18	45	CLEAR	12		VLOCL2826
	0	3.5	24	60	GREEN	12		VLOCL2836
HOS-12 1/2 CIRCLE 40mm 	0	3.5	24	60	GREEN	12		VLOCL4636

Surgipro™ II and Surgipro™ 7-0, 8-0; Sofsilik™ 8-0; Polysorb™, Biosyn™, Monosof™, Maxon™, Velosorb™ Fast sutures differ from USP and EP only in diameter. Please refer to IFU for more details.

© 2018 Medtronic. All rights reserved. Medtronic, Medtronic logo and Further, Together are trademarks of Medtronic.



™*Third party brands are trademarks of their respective owners.

All other brands are trademarks of a Medtronic company.

11/2018 US170542

V-LOC™ 180

Absorbable Wound Closure Device

PREMIUM REVERSE CUTTING									
Description	USP Size	EP Size	Length (in)	Length (cm)	Color	Units per box	Comments	Reorder code	
P-11 3/8 CIRCLE 16mm 	4-0	1.5	12		GREEN	12	Edgellant™ needle, Surgalloy™ alloy	VLOCL1413	
P-12 3/8 CIRCLE 19mm 	4-0	1.5	6		CLEAR	12	Edgellant™ needle, Surgalloy™ alloy	VLOCL0003	
	4-0	1.5	12		CLEAR	12	Edgellant™ needle, Surgalloy™ alloy	VLOCL0013	
	4-0	1.5	23		CLEAR	12	Edgellant™ needle, Surgalloy™ alloy	VLOCL0033	
	4-0	1.5	18		CLEAR	12	Edgellant™ needle, Surgalloy™ alloy	VLOCL0023	
	3-0	2	6		CLEAR	12	Edgellant™ needle, Surgalloy™ alloy	VLOCL0004	
	3-0	2	24		CLEAR	12	Edgellant™ needle, Surgalloy™ alloy	VLOCL0034	
	3-0	2	18		CLEAR	12	Edgellant™ needle, Surgalloy™ alloy	VLOCL0024	
	3-0	2	12		CLEAR	12	Edgellant™ needle, Surgalloy™ alloy	VLOCL0014	
	2-0	3	18		CLEAR	12	Edgellant™ needle, Surgalloy™ alloy	VLOCL0025	
	2-0	3	12		CLEAR	12	Edgellant™ needle, Surgalloy™ alloy	VLOCL0015	
P-14 3/8 CIRCLE 24mm 	4-0	1.5	18		CLEAR	12	Edgellant™ needle, Surgalloy™ alloy	VLOCL0123	
	4-0	1.5	23		CLEAR	12	Edgellant™ needle, Surgalloy™ alloy	VLOCL0133	
	3-0	2	24		CLEAR	12	Edgellant™ needle, Surgalloy™ alloy	VLOCL0134	
	3-0	2	18		CLEAR	12	Edgellant™ needle, Surgalloy™ alloy	VLOCL0124	
	3-0	2	12		CLEAR	12	Edgellant™ needle, Surgalloy™ alloy	VLOCL0114	
	2-0	3	24		CLEAR	12	Edgellant™ needle, Surgalloy™ alloy	VLOCL0135	
	2-0	3	12		CLEAR	12	Edgellant™ needle, Surgalloy™ alloy	VLOCL0115	
	2-0	3	18		CLEAR	12	Edgellant™ needle, Surgalloy™ alloy	VLOCL0125	
	0	3.5	12		GREEN	12	Edgellant™ needle, Surgalloy™ alloy	VLOCL3216	

Surgipro™ II and Surgipro™ 7-0, 8-0; Sofsilik™ 8-0; Polysorb™, Biosyn™, Monosof™, Maxon™, Velosorb™ Fast sutures differ from USP and EP only in diameter. Please refer to IFU for more details.

© 2018 Medtronic. All rights reserved. Medtronic, Medtronic logo and Further, Together are trademarks of Medtronic.

™*Third party brands are trademarks of their respective owners.

All other brands are trademarks of a Medtronic company.

11/2018 US170542

V-LOC™ 180

Absorbable Wound Closure Device

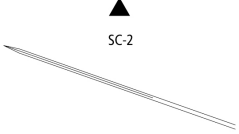
CONVENTIONAL CUTTING									
Description	USP Size	EP Size	Length (in)	Length (cm)	Color	Units per box	Comments	Reorder code	
SC-2 STRAIGHT 60mm (Not to scale) 	4-0	1.5	18	45	CLEAR	12		VLOCL0223	
	3-0	2	18	45	CLEAR	12		VLOCL0224	

Surgipro™ II and Surgipro™ 7-0, 8-0; Sofsilik™ 8-0; Polysorb™, Biosyn™, Monosof™, Maxon™, Velosorb™ Fast sutures differ from USP and EP only in diameter. Please refer to IFU for more details.

© 2018 Medtronic. All rights reserved. Medtronic, Medtronic logo and Further, Together are trademarks of Medtronic.





™*Third party brands are trademarks of their respective owners.

All other brands are trademarks of a Medtronic company.

11/2018 US170542

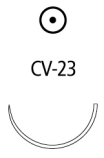
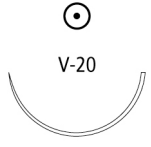
V-LOC™ 180

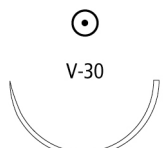
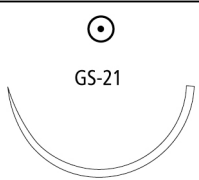
Absorbable Wound Closure Device

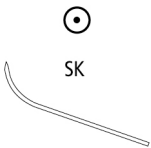
TAPER POINT									
Description		USP Size	EP Size	Length (in)	Length (cm)	Color	Units per box	Comments	Reorder code
CV-23 1/2 CIRCLE 17mm		4-0	1.5	6	15	GREEN	12	surgalloy™	VLOCL0803
		4-0	1.5	12	30	GREEN	12	Surgalloy™	VLOCL0813
		3-0	2	6	15	UNDYED	12		VLOCL1904
		3-0	2	6	15	GREEN	12		VLOCL0804
		3-0	2	9	23	GREEN	12	Surgalloy™	VLOCL0844
		3-0	2	12	30	GREEN	12		VLOCL0814
		3-0	2	18	45	GREEN	12		VLOCL0824
V-20 1/2 CIRCLE 26mm		4-0	1.5	6	15	GREEN	12	surgalloy™	VLOCL0603
		4-0	1.5	9	23	GREEN	12	Surgalloy™	VLOCL0643
		4-0	1.5	12	30	GREEN	12		VLOCL0613
		3-0	2	6	15	GREEN	12		VLOCL0604
		3-0	2	9	23	GREEN	12	Surgalloy™	VLOCL0644
		3-0	2	12	30	GREEN	12	Surgalloy™	VLOCL0614
		3-0	2	18	45	GREEN	12	Surgalloy™	VLOCL0624
		2-0	3	12	30	GREEN	12		VLOCL0615
		2-0	3	18	45	GREEN	12		VLOCL0625
		2-0	3	24	60	GREEN	12		VLOCL0635
GS-22 1/2 CIRCLE 27mm		2-0	3	6	15	GREEN	12		VLOCL2105
		2-0	3	9	23	GREEN	12		VLOCL2145
		0	3.5	9	23	GREEN	12	Robotic code	VLOCL2246
		0	3.5	12	30	GREEN	12	Robotic code	VLOCL2216
V-30 1/2 CIRCLE 30mm		3-0	2	9	23	GREEN	12		VLOCL1544
		2-0	3	9	23	GREEN	12		VLOCL1545
GS-21 1/2 CIRCLE 37mm		3-0	2	9	23	GREEN	12	Surgalloy™	VLOCL0344
		3-0	2	18	45	GREEN	12	Surgalloy™	VLOCL0324
		2-0	3	6	15	GREEN	12		VLOCL0305
		2-0	3	9	23	GREEN	12		VLOCL0345
		2-0	3	12	30	GREEN	12		VLOCL0315
		2-0	3	18	45	GREEN	12		VLOCL0325
		2-0	3	24	60	GREEN	12		VLOCL0335
		0	3.5	6	15	GREEN	12		VLOCL0306
		0	3.5	9	23	GREEN	12		VLOCL0346
		0	3.5	12	30	GREEN	12		VLOCL0316
		0	3.5	18	45	GREEN	12		VLOCL0326
		0	3.5	24	60	GREEN	12		VLOCL0336
GS-25 1/2 CIRCLE 48mm (Not to scale)		0	3.5	12	30	GREEN	12		VLOCL0416
		0	3.5	18	45	GREEN	12		VLOCL0426
		0	3.5	24	60	GREEN	12		VLOCL0436
SK SKI 23mm		3-0	2	9	23	GREEN	12		VLOCL2744

Surgipro™ II and Surgipro™ 7-0, 8-0; Sofsilik™ 8-0; Polysorb™, Biosyn™, Monosof™, Maxon™, Velosorb™ Fast sutures differ from USP and EP only in diameter. Please refer to IFU for more details.

© 2018 Medtronic. All rights reserved. Medtronic, Medtronic logo and Further, Together are trademarks of Medtronic.

™*Third party brands are trademarks of their respective owners.

All other brands are trademarks of a Medtronic company.

11/2018 US170542

V-LOC™ 180

Absorbable Wound Closure Device

Reorder Code	Page	Reorder Code	Page	Reorder Code	Page
VLOCL0003	238	VLOCL0615	240		
VLOCL0004	238	VLOCL0624	240		
VLOCL0013	238	VLOCL0625	240		
VLOCL0014	238	VLOCL0635	240		
VLOCL0015	238	VLOCL0643	240		
VLOCL0023	238	VLOCL0644	240		
VLOCL0024	238	VLOCL0803	240		
VLOCL0025	238	VLOCL0804	240		
VLOCL0033	238	VLOCL0813	240		
VLOCL0034	238	VLOCL0814	240		
VLOCL0114	238	VLOCL0824	240		
VLOCL0115	238	VLOCL0844	240		
VLOCL0123	238	VLOCL1413	238		
VLOCL0124	238	VLOCL1544	240		
VLOCL0125	238	VLOCL1545	240		
VLOCL0133	238	VLOCL1904	240		
VLOCL0134	238	VLOCL2105	240		
VLOCL0135	238	VLOCL2145	240		
VLOCL0223	239	VLOCL2216	240		
VLOCL0224	239	VLOCL2246	240		
VLOCL0305	240	VLOCL2744	240		
VLOCL0306	240	VLOCL2815	237		
VLOCL0315	240	VLOCL2825	237		
VLOCL0316	240	VLOCL2826	237		
VLOCL0324	240	VLOCL2836	237		
VLOCL0325	240	VLOCL3216	238		
VLOCL0326	240	VLOCL4636	237		
VLOCL0335	240				
VLOCL0336	240				
VLOCL0344	240				
VLOCL0345	240				
VLOCL0346	240				
VLOCL0416	240				
VLOCL0426	240				
VLOCL0436	240				
VLOCL0603	240				
VLOCL0604	240				
VLOCL0613	240				
VLOCL0614	240				

Surgipro™ II and Surgipro™ 7-0, 8-0; Sofsilik™ 8-0; Polysorb™, Biosyn™, Monosof™, Maxon™, Velosorb™ Fast sutures differ from USP and EP only in diameter. Please refer to IFU for more details.

© 2018 Medtronic. All rights reserved. Medtronic, Medtronic logo and Further, Together are trademarks of Medtronic.

™*Third party brands are trademarks of their respective owners.

All other brands are trademarks of a Medtronic company.

11/2018 US170542



V-LOC™ PBT

Non-Absorbable Wound Closure Device

Description	The V-Loc™ Polybutester (PBT) non-absorbable wound closure device consists of a barbed non-absorbable thread, armed with a surgical needle at one end and a loop end effector at the other. The barb and loop end effector design allow for tissue approximation without the need to tie surgical knots. The V-Loc™ PBT nonabsorbable wound closure device is composed of a copolymer of butylene terephthalate and polytetramethylene ether glycol. The device is sterile, inert, noncollagenous and nonantigenic.
Indications	V-Loc™ PBT non-absorbable wound closure devices are indicated for soft tissue approximation.
Actions	The V-Loc™ PBT non-absorbable wound closure device elicits a minimal acute inflammatory reaction in tissues, followed by gradual encapsulation of the suture by fibrous connective tissue.
Tensile Strength	No known significant change in tensile retention occurs in vivo for the V-Loc™ PBT non-absorbable wound closure device.
Sterilization	Ethylene oxide.
Packaging	The V-Loc™ PBT non-absorbable wound closure devices are available in USP and EP sizes 1 (4 Metric) through 3-0 (2 Metric). The V-Loc™ PBT non-absorbable wound closure devices are pigmented with Copper Phthalocyanine Blue. The devices are supplied sterile, affixed to taperpoint needle types. The devices are available in box quantities of one dozen. Please refer to the individual package IFUs for complete instructions, indications, contraindications, warnings and precautions.

V-LOC™ PBT

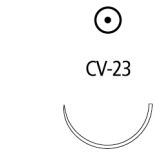
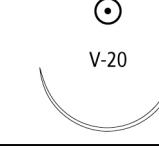
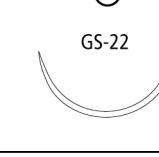
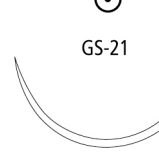
Non-Absorbable Wound Closure Device

TAPER POINT									
Description		USP Size	EP Size	Length (in)	Length (cm)	Color	Units per box	Comments	Reorder code
CV-23 1/2 CIRCLE 17mm	 <p>CV-23</p>	3-0	2	6	15	BLUE	12		VLOCN0804
		3-0	2	12	30	BLUE	12	Surgalloy™	VLOCN0814
V-20 1/2 CIRCLE 26mm	 <p>V-20</p>	3-0	2	6	15	BLUE	12		VLOCN0604
		3-0	2	9	23	BLUE	12	surgalloy™	VLOCN0644
		3-0	2	12	30	BLUE	12	Surgalloy™	VLOCN0614
		2-0	3	6	15	BLUE	12		VLOCN0605
		2-0	3	12	30	BLUE	12		VLOCN0615
GS-22 1/2 CIRCLE 27mm	 <p>GS-22</p>	2-0	3	6	15	BLUE	12	Robotic code	VLOCN2105
		2-0	3	9	23	BLUE	12	Robotic code	VLOCN2145
		0	3.5	6	15	BLUE	12	Robotic code	VLOCN2106
		0	3.5	9	23	BLUE	12	Robotic code	VLOCN2146
		0	3.5	18	45	BLUE	12		VLOCN1126
		1	4	9	23	BLUE	12	Robotic code	VLOCN2147
		1	4	12	30	BLUE	12	Robotic code	VLOCN2117
GS-21 1/2 CIRCLE 37mm	 <p>GS-21</p>	2-0	3	6	15	BLUE	12		VLOCN0305
		2-0	3	9	23	BLUE	12	Robotic code	VLOCN0345
		2-0	3	18	45	BLUE	12		VLOCN0325
		0	3.5	6	15	BLUE	12		VLOCN0306
		0	3.5	9	23	BLUE	12	Robotic code	VLOCN0346
		0	3.5	18	45	BLUE	12		VLOCN0326
		1	4	9	23	BLUE	12	Robotic code	VLOCN0347
		1	4	12	30	BLUE	12		VLOCN0317
		1	4	18	45	BLUE	12		VLOCN0327
GS-25 1/2 CIRCLE 48mm (Not to scale)	 <p>GS-25</p>	1	4	24	60	BLUE	12		VLOCN0437

Surgipro™ II and Surgipro™ 7-0, 8-0; Sofsilik™ 8-0; Polysorb™, Biosyn™, Monosof™, Maxon™, Velosorb™ Fast sutures differ from USP and EP only in diameter. Please refer to IFU for more details.

© 2018 Medtronic. All rights reserved. Medtronic, Medtronic logo and Further, Together are trademarks of Medtronic.

™*Third party brands are trademarks of their respective owners.

All other brands are trademarks of a Medtronic company.

11/2018 US170542

V-LOC™ PBT

Non-Absorbable Wound Closure Device

Reorder Code	Page	Reorder Code	Page	Reorder Code	Page
<u>VLOCN0305</u>	<u>245</u>				
<u>VLOCN0306</u>	<u>245</u>				
<u>VLOCN0317</u>	<u>245</u>				
<u>VLOCN0325</u>	<u>245</u>				
<u>VLOCN0326</u>	<u>245</u>				
<u>VLOCN0327</u>	<u>245</u>				
<u>VLOCN0345</u>	<u>245</u>				
<u>VLOCN0346</u>	<u>245</u>				
<u>VLOCN0347</u>	<u>245</u>				
<u>VLOCN0437</u>	<u>245</u>				
<u>VLOCN0604</u>	<u>245</u>				
<u>VLOCN0605</u>	<u>245</u>				
<u>VLOCN0614</u>	<u>245</u>				
<u>VLOCN0615</u>	<u>245</u>				
<u>VLOCN0644</u>	<u>245</u>				
<u>VLOCN0804</u>	<u>245</u>				
<u>VLOCN0814</u>	<u>245</u>				
<u>VLOCN1126</u>	<u>245</u>				
<u>VLOCN2105</u>	<u>245</u>				
<u>VLOCN2106</u>	<u>245</u>				
<u>VLOCN2117</u>	<u>245</u>				
<u>VLOCN2145</u>	<u>245</u>				
<u>VLOCN2146</u>	<u>245</u>				
<u>VLOCN2147</u>	<u>245</u>				

Surgipro™ II and Surgipro™ 7-0, 8-0; Sofsilik™ 8-0; Polysorb™, Biosyn™, Monosof™, Maxon™, Velosorb™ Fast sutures differ from USP and EP only in diameter. Please refer to IFU for more details.

© 2018 Medtronic. All rights reserved. Medtronic, Medtronic logo and Further, Together are trademarks of Medtronic.

™*Third party brands are trademarks of their respective owners.

All other brands are trademarks of a Medtronic company.

11/2018 US170542

PTFE Polymer PLEDGETS Medtronic

Non-absorbable pre-punched

Description	PTFE Pledgets are non-absorbable, undyed fabrics composed of poly (tetrafluoroethylene).
Indications	PTFE Pledgets are indicated for use as non-absorbable suture buttresses when there is a possibility of sutures tearing through tissue. These pledgets are used in various surgical procedures such as vascular closure, septal repair, myocardial closure, valvular suturing and hepatic repair.
Actions	PTFE Pledgets elicit a minimal acute inflammatory reaction in tissues, followed by gradual encapsulation of the fabric by fibrous connective tissue.
Packaging	PTFE Pledgets are available sterile, prepunched, square , rectangular or oval in shape and in box quantities of 3 dozen.

PTFE Polymer PLEDGETS Medtronic

Non-absorbable pre-punched

PLEDGET									
Description	USP Size	EP Size	Length (in)	Length (cm)	Color	Units per box	Comments	Reorder code	
PLEDGET						36	10 strands, Oval Pledget 3x6mm SOFT	VPG36SE	
						36	10 strands, Oval Pledget 4.5x6mm SOFT	VPG56SE	
						36	10 strands, Oval Pledget 4.5x6mm FIRM	VPG56FE	
						36	10 strands, Oval Pledget 3x6mm FIRM	VPG36FE	
						36	10 strands, Pledget 3x7mm SOFT	88868682-01	
						36	Pledget 4.8x9.5mm FIRM	88868678-01	
						36	Pledget 4.8x9.5mm SOFT	88868679-01	
						36	10 strands, Pledget 3x3mm FIRM	88868675-01	
						36	10 strands, Pledget 3x7mm FIRM	88868677-01	

Surgipro™ II and Surgipro™ 7-0, 8-0; Sofsilik™ 8-0; Polysorb™, Biosyn™, Monosof™, Maxon™, Velosorb™ Fast sutures differ from USP and EP only in diameter. Please refer to IFU for more details.

© 2018 Medtronic. All rights reserved. Medtronic, Medtronic logo and Further, Together are trademarks of Medtronic.

™*Third party brands are trademarks of their respective owners.

All other brands are trademarks of a Medtronic company.

11/2018 US170542

PTFE Polymer PLEDGETS Medtronic

Non-absorbable pre-punched

Reorder Code

Page

Reorder Code

Page

Reorder Code

Page

Surgipro™ II and Surgipro™ 7-0, 8-0; Sofsilik™ 8-0; Polysorb™, Biosyn™, Monosof™, Maxon™, Velosorb™ Fast sutures differ from USP and EP only in diameter. Please refer to IFU for more details.

© 2018 Medtronic. All rights reserved. Medtronic, Medtronic logo and Further, Together are trademarks of Medtronic.

™*Third party brands are trademarks of their respective owners.

All other brands are trademarks of a Medtronic company.

11/2018 US170542

BONE WAX

Description	USP Size	EP Size	Length (in)	Length (cm)	Color	Units per box	Comments	Reorder code
								BW25G

Surgipro™ II and Surgipro™ 7-0, 8-0; Sofsilik™ 8-0; Polysorb™, Biosyn™, Monosof™, Maxon™, Velosorb™ Fast sutures differ from USP and EP only in diameter. Please refer to IFU for more details.

© 2018 Medtronic. All rights reserved. Medtronic, Medtronic logo and Further, Together are trademarks of Medtronic.

™*Third party brands are trademarks of their respective owners.

All other brands are trademarks of a Medtronic company.

11/2018 US170542

BONE WAX

Reorder Code

Page

Reorder Code

Page

Reorder Code

Page

Surgipro™ II and Surgipro™ 7-0, 8-0; Sofsilik™ 8-0; Polysorb™, Biosyn™, Monosof™, Maxon™, Velosorb™ Fast sutures differ from USP and EP only in diameter. Please refer to IFU for more details.

© 2018 Medtronic. All rights reserved. Medtronic, Medtronic logo and Further, Together are trademarks of Medtronic.

™*Third party brands are trademarks of their respective owners.

All other brands are trademarks of a Medtronic company.

11/2018 US170542

IMPORTANT: Please refer to the package insert for complete instructions, contraindications, warnings and precautions.

© 2017 Medtronic. All rights reserved. Medtronic, Medtronic logo and Further, Together are trademarks of Medtronic. All other brands are trademarks of a Medtronic company. 07/2017 US170542

Medtronic



To contact us, please visit
www.medtronic.com/covidien/en-us/support.html

Use scan app to read